

ST-101F2

Aliases (UDLST00101F200)

KEMET, ST, DC Line Filters, Common Mode

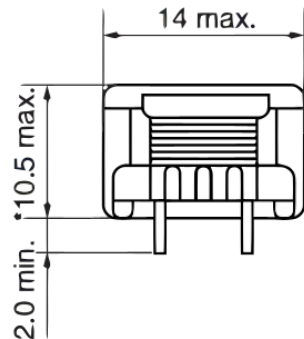

*11.5 max. with ST-101F4

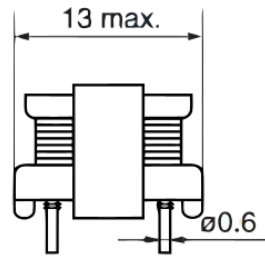

General Information

Series	ST
Style	Through-Hole
RoHS	Yes
Miscellaneous	AM Band, Frequency Range: 0.5 To 7 MHz, Impedance: 40000 Ohms (600 kHz)

Specifications

Voltage DC	50 VDC
Temperature Range	-20/+75°C
DC Resistance	2.7 Ohms

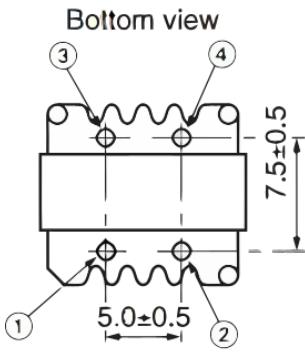

(ST-101F2)

Click [here](#) for the 3D model.

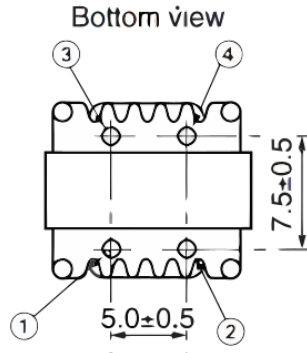

(ST-101F4)

Dimensions

L	14mm MAX
W	13mm MAX
H	10.5mm MAX
LL	2mm MIN
S	7.5mm +/-0.5mm

Packaging Specifications

Packaging	Tray, Box
Packaging Quantity	1600
Component Weight	2.9 g

Statements of suitability for certain applications are based on our knowledge of typical operating conditions for such applications, but are not intended to constitute - and we specifically disclaim - any warranty concerning suitability for a specific customer application or use. This information is intended for use only by customers who have the requisite experience and capability to determine the correct products for their application. Any technical advice inferred from this information or otherwise provided by us with reference to the use of our products is given gratis, and we assume no obligation or liability for the advice given or results obtained.

单击下面可查看定价，库存，交付和生命周期等信息

[>>KEMET\(基美\)](#)