

T429 CWR29, Tantalum, MnO2 Tantalum, Military/High Reliability, 47 uF, 10%, 20 VDC, SMD, MnO2, Molded, Military Equivalent, Low ESR, C (0.01%/1000 Hrs), 200 mOhms, 7238, Height Max = 3.17mm

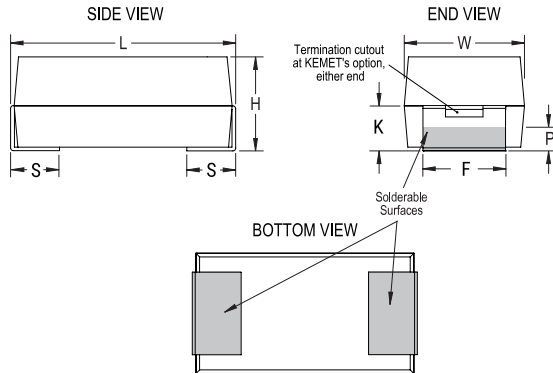

Dimensions	
Footprint	7238
L	7.24mm +/-0.38mm
W	3.81mm +/-0.38mm
H	2.79mm +/-0.38mm
S	1.27mm +0.25/-0.13mm
F	3.68mm +0.13/-0.51mm
K	1.52mm MIN
P	0.76mm MIN

Packaging Specifications	
Packaging:	Waffle

General Information	
Series:	T429 CWR29
Dielectric:	MnO2 Tantalum
Style:	SMD Chip
Description:	SMD, MnO2, Molded, Military Equivalent, Low ESR
RoHS:	No
Prop 65:	WARNING: Cancer and reproductive harm - www.p65warnings.ca.gov .
SCIP Number:	652b281f-d242-4453-bc44-0655d646cec3
Termination:	Hot Solder Dipped
Qualifications:	MIL-PRF-55365/11, CWR29 Style
AEC-Q200:	No
Component Weight:	349.01 mg
Notes:	Note: When Option C Is Selected For Lead Material, Add An Additional 0.38mm To The Tolerances For "L", "W", "H", "K", "F" And "S".
MSL:	1

Specifications	
Capacitance:	47 uF
Capacitance Tolerance:	10%
Voltage DC:	20 VDC (85C), 13.4 VDC (125C)
Temperature Range:	-55/+125°C
Rated Temperature:	85°C
Dissipation Factor:	8% 120Hz 25C
Failure Rate:	C (0.01%/1000 Hrs)
Resistance:	0.2 Ohms (100kHz 25C)
Leakage Current:	10 uA (5min 25°C)
Testing and Reliability:	Surge Testing At -55C And +85C After Weibull

Statements of suitability for certain applications are based on our knowledge of typical operating conditions for such applications, but are not intended to constitute - and we specifically disclaim - any warranty concerning suitability for a specific customer application or use. This Information is intended for use only by customers who have the requisite experience and capability to determine the correct products for their application. Any technical advice inferred from this Information or otherwise provided by us with reference to the use of our products is given gratis, and we assume no obligation or liability for the advice given or results obtained.

单击下面可查看定价，库存，交付和生命周期等信息

[>>KEMET\(基美\)](#)