

PEH532, Aluminum Electrolytic, 10,000 uF, 20%, 63 VDC, -40/+105°C

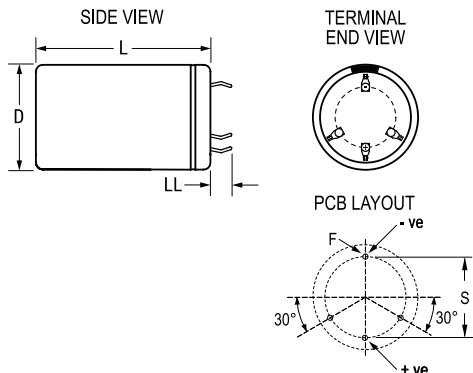

General Information	
Series:	PEH532
Dielectric:	Aluminum Electrolytic
Description:	Snap-In, Aluminum Electrolytic
RoHS:	Yes
Lead:	4 Pin Short
AEC-Q200:	No
Component Weight:	72 g
Notes:	Add 0.5mm To D And 1mm To L For Sleeving.
Shelf Life:	208 Weeks

Dimensions	
D	35mm +/-0.5mm
L	50mm +/-1mm
S	22.5mm NOM
LL	4mm +/-1mm
F	2mm +/-0.1mm

Specifications	
Capacitance:	10,000 uF
Capacitance Tolerance:	20%
Voltage DC:	63 VDC
Temperature Range:	-40/+105°C
Rated Temperature:	105°C
Life:	1500 Hrs (Rated Voltage And Ripple Current At 105C), 2000 Hrs (Rated Voltage At 105C)
Resistance:	22 mOhms (100Hz 20C), 17 mOhms (100kHz 20C)
Ripple Current:	5.2 Amps (100Hz 105C), 14.4 Amps (20kHz 40C)
Leakage Current:	1890 uA (5min 20°C)

Packaging Specifications	
Packaging:	Bulk, Bag
Packaging Quantity:	100

Statements of suitability for certain applications are based on our knowledge of typical operating conditions for such applications, but are not intended to constitute - and we specifically disclaim - any warranty concerning suitability for a specific customer application or use. This Information is intended for use only by customers who have the requisite experience and capability to determine the correct products for their application. Any technical advice inferred from this Information or otherwise provided by us with reference to the use of our products is given gratis, and we assume no obligation or liability for the advice given or results obtained.

单击下面可查看定价，库存，交付和生命周期等信息

[>>KEMET\(基美\)](#)