

R75IC2150DQ45J

R75, Film, Metallized Polypropylene, General Purpose, 0.015 uF, 5%, 250 VDC, 85°C, Lead Spacing = 5mm

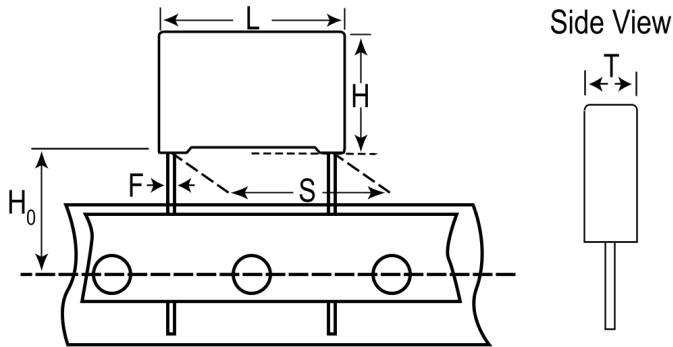

Click [here](#) for the 3D model.

Dimensions

L	7.2mm +0.2/-0.5mm
H	7.5mm +0.1/-0.5mm
T	3.5mm +0.1/-0.5mm
S	5mm +/-0.4mm
H0	18.5mm +/-0.5mm
F	0.5mm +/-0.05mm

Packaging Specifications

Packaging	Ammo
Packaging Quantity	2500

General Information

Series	R75
Dielectric	Metallized Polypropylene
Style	Radial
Features	Automotive Grade, Pulse
RoHS	Yes
Lead	Wire Leads
AEC-Q200	No
Miscellaneous	Above 85C DC And AC Voltage Derating Is 1.25%/C.

Specifications

Capacitance	0.015 uF
Capacitance Tolerance	5%
Voltage AC	160 VAC
Voltage DC	250 VDC
Temperature Range	-55/+105°C
Rated Temperature	85°C
Insulation Resistance	100 GOhms
Max dV/dt	250 V/us
Resistance	318.3 mOhms (100kHz)
Ripple Current	0.753 Amps (100kHz 85C), 4 Amps (Peak)
Inductance	7 nH

Statements of suitability for certain applications are based on our knowledge of typical operating conditions for such applications, but are not intended to constitute - and we specifically disclaim - any warranty concerning suitability for a specific customer application or use. This information is intended for use only by customers who have the requisite experience and capability to determine the correct products for their application. Any technical advice inferred from this information or otherwise provided by us with reference to the use of our products is given gratis, and we assume no obligation or liability for the advice given or results obtained.

单击下面可查看定价，库存，交付和生命周期等信息

[>>KEMET\(基美\)](#)