

SMD Comm X7R FO, Ceramic, 0.22 uF, 10%, 100 VDC, X7R, SMD, MLCC, Open Mode, Temperature Stable, 1210

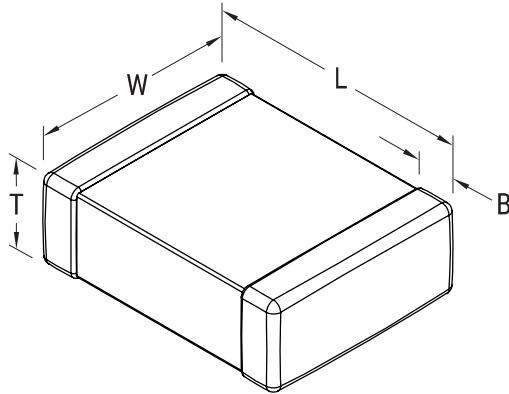

Dimensions	
Chip Size	1210
L	3.3mm +/-0.4mm
W	2.6mm +/-0.3mm
T	1.25mm +/-0.20mm
B	0.6mm +/-0.25mm

Packaging Specifications	
Packaging:	Bulk, Bag
Packaging Quantity:	1

General Information	
Series:	SMD Comm X7R FO
Style:	SMD Chip
Description:	SMD, MLCC, Open Mode, Temperature Stable
Features:	Open Mode, Temperature Stable
RoHS:	Yes
Termination:	Flexible Termination
Marking:	No
AEC-Q200:	No
Component Weight:	65 mg
Shelf Life:	78 Weeks
MSL:	1

Specifications	
Capacitance:	0.22 uF
Measurement Condition:	1 kHz 1.0Vrms
Capacitance Tolerance:	10%
Voltage DC:	100 VDC
Dielectric Withstanding Voltage:	250 VDC
Temperature Range:	-55/+125°C
Temperature Coefficient:	X7R
Capacitance Change with Reference to +25°C and 0 VDC Applied (TCC):	15%, 1kHz 1.0Vrms
Dissipation Factor:	2.5% 1 kHz 1.0Vrms
Aging Rate:	3% Loss/Decade Hour: Referee Time is 1000 Hours
Insulation Resistance:	4.5455 GOhms

单击下面可查看定价，库存，交付和生命周期等信息

[>>KEMET\(基美\)](#)