

R71H, 125°C Single Metallized Polypropylene Film, Radial, SMPS PFC Applications

Overview

The R71H is constructed of metallized polypropylene film with radial leads of tinned wire. The radial leads are electrically welded to the metal layer on the ends of the capacitor winding. The capacitor is encapsulated in a self-extinguishing solvent resistant plastic case with thermosetting resin material meeting UL 94 V-0 requirements.

Automotive grade devices meet the demanding Automotive Electronics Council's AEC-Q200 qualification requirements.

Applications

Typical applications include power factor correction applications.

Not suitable for across-the-line application (see Suppressor Capacitors).

Benefits

- Voltage range: 450 – 630 VDC
- Capacitance range: 0.033 – 22 μ F
- Lead Spacing: 10 – 27.5 mm
- Capacitance tolerance: $\pm 10\%$, $\pm 20\%$, $\pm 5\%$ (on request)
- Climatic category: 55/110/56 IEC 60068-1
- Operating temperature range of -55°C to $+125^{\circ}\text{C}$
- RoHS compliance and lead-free terminations
- Tape & Reel packaging in accordance with IEC 60286-2
- Self-healing

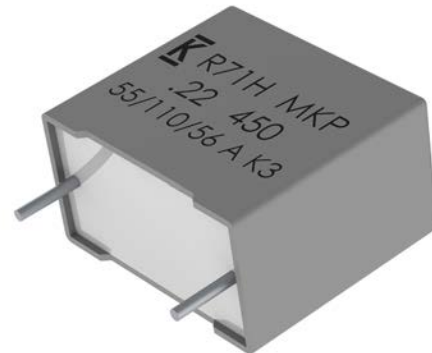

Part Number System

R71	X	I	4100	AA	H0		K
Series	Rated Voltage (VDC)	Lead Spacing (mm)	Capacitance Code (pF)	Packaging	Internal Use		Capacitance Tolerance
Metallized Polypropylene	X = 450 V = 520 P = 630	F = 10 I = 15 N = 22.5 R = 27.5	The last three digits represent significant figures. The first digit specifies the total number of zeros to be added.	See Ordering Options Table	H0 H1 H2 H3	H4 H5 H6 H7	J = $\pm 5\%$ K = $\pm 10\%$ M = $\pm 20\%$

Built Into Tomorrow

Ordering Options Table

Lead Spacing Nominal (mm)	Type of Leads and Packaging	Lead Length (mm)	Lead and Packaging Code
10 15 22.5	Standard Lead and Packaging Options		
	Bulk (Bag) ² – Short Leads	4 +2/-0	AA
	Ammo Pack	H ₀ = 18.5±0.5	DQ
	Other Lead and Packaging Options		
	Tape & Reel (Standard Reel Ø 355 mm)	H ₀ = 18.5±0.5	GY
	Tape & Reel (Large Reel Ø 500 mm)	H ₀ = 18.5±0.5	CK
	Bulk (Bag) ² – Short Leads	3.5 +0.5/-0	JB
	Bulk (Bag) ² – Short Leads	4.0 +0.5/-0	JE
	Bulk (Bag) ² – Short Leads	3.2 +0.3/-0.2	JH
	Bulk (Bag) – Long Leads	18±1	JM
	Bulk (Bag) – Long Leads	30 +5/-0	40
Bulk (Bag) – Long Leads	25 +2/-1	50	
27.5	Standard Lead and Packaging Options		
	Bulk (Tray) – Short Leads	4 +2/-0	AA
	Other Lead and Packaging Options		
	Tape & Reel (Standard Reel Ø 355 mm)	H ₀ = 18.5±0.5	GY
	Tape & Reel (Large Reel Ø 500 mm)	H ₀ = 18.5±0.5	CK ¹
	Bulk (Tray) – Short Leads	3.5 +0.5/-0	JB
	Bulk (Tray) – Short Leads	4.0 +0.5/-0	JE
	Bulk (Tray) – Short Leads	3.2 +0.3/-0.2	JH
	Bulk (Tray) – Long Leads	18±1	JM
	Bulk (Tray) – Long Leads	30 +5/-0	40
	Bulk (Tray) – Long Leads	25 +2/-1	50

¹ = Not for all sizes, see "Packaging Quantities" table.

² = For lead spacing 22.5 case sizes ≥ 8.5*17*26.5 the parts are packed in a Pizza box 335*320*34 mm

Dimensions – Millimeters



S		T		H		L		F	
Nominal	Tolerance	Nominal	Tolerance	Nominal	Tolerance	Nominal	Tolerance	Nominal	Tolerance
10.0	±0.4	4.0	+0.2/-0.5	9.0	+0.1/-0.5	13.0	+0.2/-0.5	0.6	±0.05
10.0	±0.4	5.0	+0.2/-0.5	11.0	+0.1/-0.5	13.0	+0.2/-0.5	0.6	±0.05
10.0	±0.4	6.0	+0.2/-0.5	12.0	+0.1/-0.5	13.0	+0.2/-0.5	0.6	±0.05
15.0	±0.4	5.0	+0.2/-0.5	11.0	+0.1/-0.5	18.0	+0.3/-0.5	0.8	±0.05
15.0	±0.4	6.0	+0.2/-0.5	12.0	+0.1/-0.5	18.0	+0.3/-0.5	0.8	±0.05
15.0	±0.4	6.0	+0.2/-0.5	17.5	+0.1/-0.5	18.0	+0.3/-0.5	0.8	±0.05
15.0	±0.4	7.5	+0.2/-0.5	13.5	+0.1/-0.5	18.0	+0.5/-0.5	0.8	±0.05
15.0	±0.4	7.5	+0.2/-0.5	18.5	+0.1/-0.5	18.0	+0.5/-0.5	0.8	±0.05
15.0	±0.4	8.5	+0.2/-0.5	14.5	+0.1/-0.5	18.0	+0.5/-0.5	0.8	±0.05
15.0	±0.4	9.0	+0.2/-0.5	12.5	+0.1/-0.5	18.0	+0.5/-0.5	0.8	±0.05
15.0	±0.4	10.0	+0.2/-0.5	16.0	+0.1/-0.5	18.0	+0.5/-0.5	0.8	±0.05
15.0	±0.4	11.0	+0.2/-0.5	19.0	+0.1/-0.5	18.0	+0.5/-0.5	0.8	±0.05
15.0	±0.4	13.0	+0.2/-0.5	12.0	+0.1/-0.5	18.0	+0.5/-0.5	0.8	±0.05
22.5	±0.4	6.0	+0.2/-0.5	15.0	+0.1/-0.5	26.5	+0.3/-0.5	0.8	±0.05
22.5	±0.4	7.0	+0.2/-0.5	16.0	+0.1/-0.5	26.5	+0.3/-0.5	0.8	±0.05
22.5	±0.4	8.5	+0.2/-0.5	17.0	+0.1/-0.5	26.5	+0.3/-0.5	0.8	±0.05
22.5	±0.4	10.0	+0.2/-0.5	18.5	+0.1/-0.5	26.5	+0.3/-0.5	0.8	±0.05
22.5	±0.4	11.0	+0.2/-0.5	20.0	+0.1/-0.5	26.5	+0.3/-0.5	0.8	±0.05
22.5	±0.4	13.0	+0.2/-0.5	22.0	+0.1/-0.5	26.5	+0.3/-0.5	0.8	±0.05
27.5	±0.4	9.0	+0.2/-0.7	17.0	+0.1/-0.7	32.0	+0.3/-0.7	0.8	±0.05
27.5	±0.4	11.0	+0.2/-0.7	20.0	+0.1/-0.7	32.0	+0.3/-0.7	0.8	±0.05
27.5	±0.4	13.0	+0.2/-0.7	22.0	+0.1/-0.7	32.0	+0.3/-0.7	0.8	±0.05
27.5	±0.4	13.0	+0.2/-0.7	25.0	+0.1/-0.7	32.0	+0.3/-0.7	0.8	±0.05
27.5	±0.4	14.0	+0.2/-0.7	28.0	+0.1/-0.7	32.0	+0.3/-0.7	0.8	±0.05
27.5	±0.4	16.0	+0.2/-0.7	30.0	+0.1/-0.7	32.0	+0.3/-0.7	0.8	±0.05
27.5	±0.4	18.0	+0.2/-0.7	33.0	+0.1/-0.7	32.0	+0.3/-0.7	0.8	±0.05
27.5	±0.4	22.0	+0.2/-0.7	37.0	+0.1/-0.7	32.0	+0.3/-0.7	0.8	±0.05

Note: See Ordering Options Table for lead length (LL/H₀) options.

Performance Characteristics

Dielectric	Polypropylene film				
Plates	Metal layer deposited by evaporation under vacuum				
Winding	Non-inductive type				
Leads	Tinned wire				
Protection	Plastic case, thermosetting resin filled. Box material is solvent resistant and flame retardant according to UL94.				
Rated Voltage V_R	450 VDC 160 VAC	520 VDC 200 VAC	630 VDC 220 VAC		
Capacitance Range (μF)	0.1 – 22	0.1 – 15	0.033 – 10		
Capacitance Values	E12 series (IEC 60063) measured at 1 kHz and +20 \pm 1°C				
Capacitance Tolerance	\pm 10%, \pm 20%, \pm 5% on request				
Operating Temperature Range	-55°C to +125°C				
Rated Temperature T_R	+85°C				
Voltage Derating	The following decreasing factor has to be applied on the rated voltage: +85°C to 125°C: 1.25% per °C for V_R (DC and AC) = operating voltage V_{op}				
Climatic Category	55/110/56 IEC 60068-1				
Storage Conditions	Storage time: \leq 24 months from the date marked on the package label				
	Average relative humidity per year \leq 70%				
	RH \leq 85% for 30 days randomly distributed throughout the year				
	Dew is absent				
	Temperature: -40 to 80°C (see "Maximum Humidity in Storage Conditions" graph below)				
Test Voltage	1.5 x V_R VDC for 2 seconds (between terminations) at +25°C \pm 5°C				
Capacitance Drift	Maximum 0.5% after a 2 year storage period at a temperature of +10°C to +40°C and a relative humidity of 40% to 60%				
Maximum Pulse Steepness	dV/dt according to Table 1. For working voltages lower than rated voltage ($V < V_R$), the specified dV/dt can be multiplied by the factor V_R/V .				
Temperature Coefficient	-(200 \pm 100) ppm/°C at 1 kHz				
Self-Inductance (Lead Length ~ 2 mm)	Lead Spacing (mm)	10	15	22.5	27.5
	L (nH) \approx	9	10	16	18
	Maximum 1 nH per 1 mm lead and capacitor length.				
Dissipation Factor ($\tan\delta$) at 1 kHz at 25°C \pm 5°C	for $C \leq 2.2 \mu\text{F}$: $\leq 0.1\%$ (0.04%)*				
	for $C > 2.2 \mu\text{F}$: $\leq 0.15\%$ (0.06%)*				
Insulation Resistance	Measured at +25°C, 100 VDC 60 seconds				
	Minimum Values Between Terminals				
	$C \leq 0.33 \mu\text{F}$		$C > 0.33 \mu\text{F}$		
$\geq 100,000 \text{ M}\Omega$ ($\geq 500,000 \text{ M}\Omega$)*		$\geq 30,000 \text{ M}\Omega \cdot \mu\text{F}$ ($\geq 150,000 \text{ M}\Omega \cdot \mu\text{F}$)*			

* Typical value

Performance Characteristics cont.

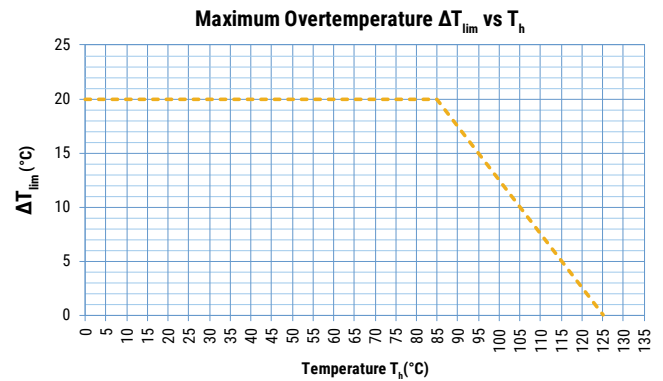
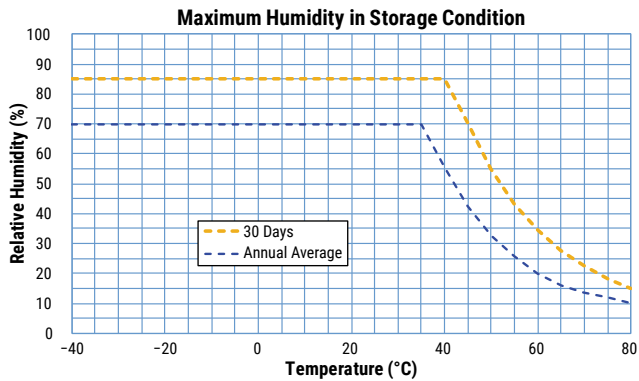

T_h is the maximum ambient temperature surrounding the capacitor or hottest contact point (e.g. tracks), whichever is higher, in the worst operation conditions in °C.

Qualification

Automotive Grade products meet or exceed the requirements outlined by the Automotive Electronics Council. Details regarding test methods and conditions are referenced in document AEC-Q200, Stress Test Qualification for Passive Components. For additional information regarding the Automotive Electronics Council and AEC-Q200, please visit their website at www.aecouncil.com.

Maximum Voltage (V_{rms}) Versus Frequency (Sinusoidal Waveform/ $T_h \leq 85^\circ\text{C}$)

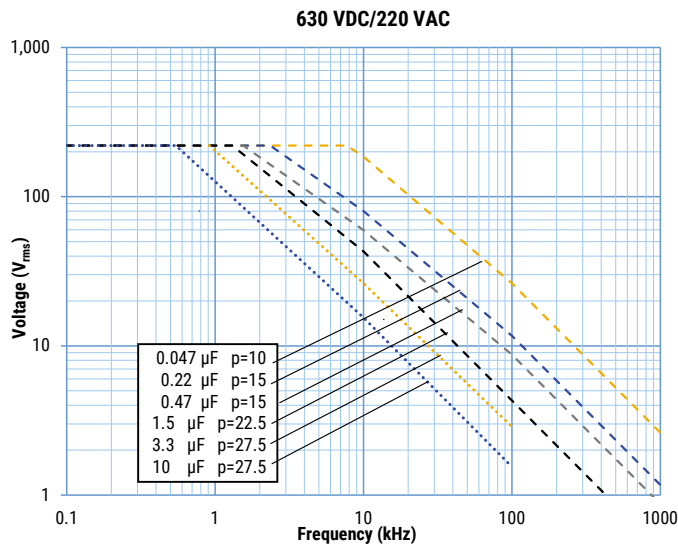
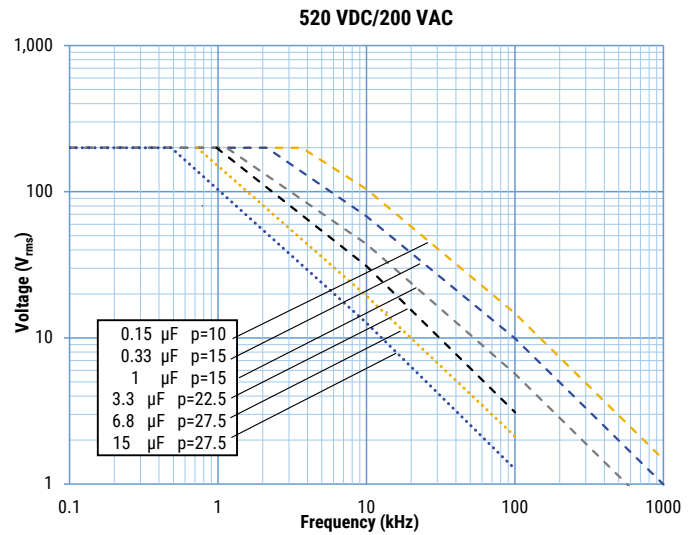
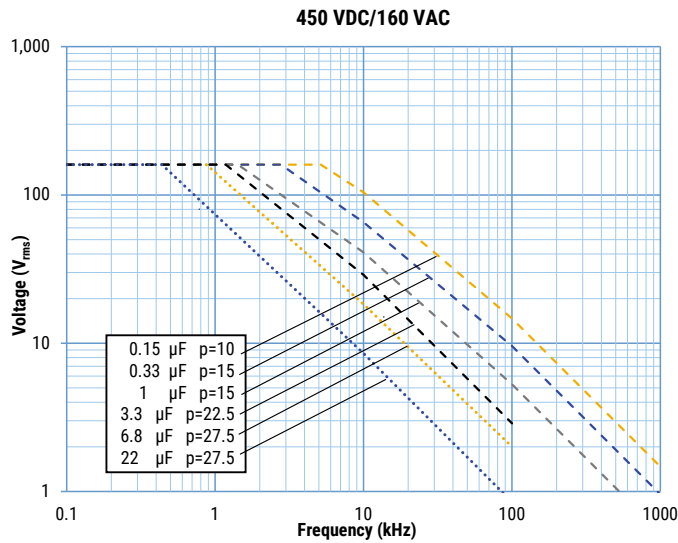

Maximum Current (I_{rms}) Versus Frequency (Sinusoidal Waveform/ $Th \leq 85^\circ C$)

450 VDC/160 VAC

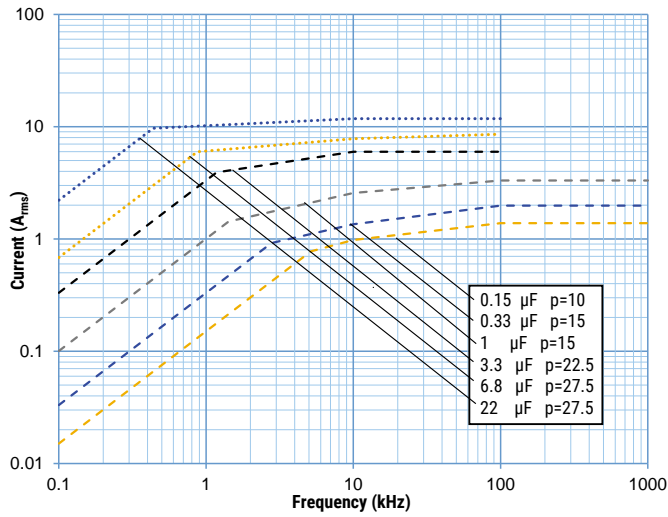

520 VDC/200 VAC

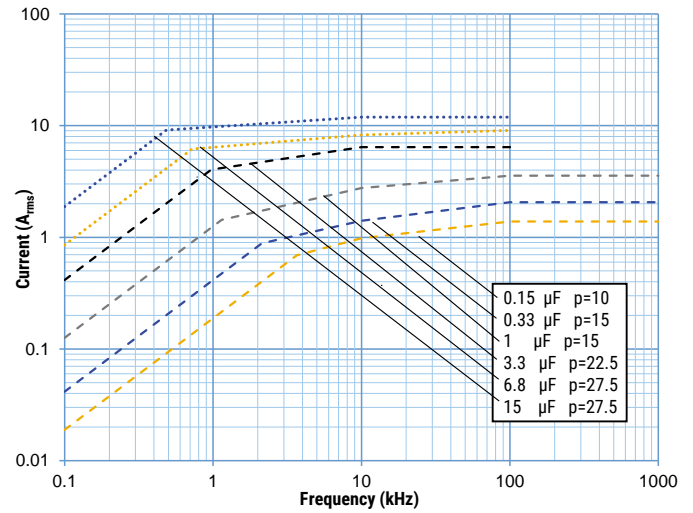

630 VDC/220 VAC

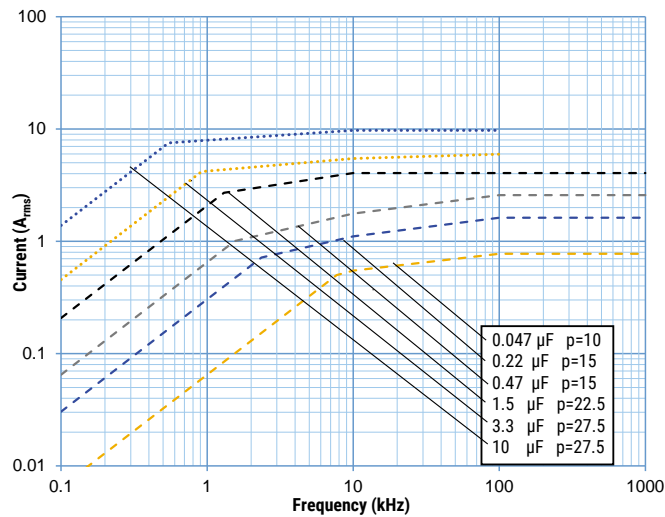

Environmental Test Data

Damp Heat, Steady State Test	Test Conditions:		Performances
	Temperature: Relative humidity (RH): Test duration:	+40°C ±2°C 93% ±2% 56 days	Δ C/C ≤ 5%, IR after test ≥ 50% of initial limit
Endurance Test	Test Conditions		Performances
	Temperature: Voltage applied: Test duration:	+105°C ±2°C 1.0 x V _{OP} (DC, AC 50/60 Hz) 1,000 hours	Δ C/C ≤ 5%, IR after test ≥ 50% of initial limit
	Temperature: Voltage applied: Test duration:	+125°C ±2°C 1.0 x V _{OP} (DC, AC 50/60 Hz) 1,000 hours	Δ C/C ≤ 5%, IR after test ≥ 50% of initial limit
	Temperature: Relative humidity (RH): Voltage applied: Test duration:	+40°C ±2°C 93% ±2% 1.0 x VR (DC) 1,000 hours	Δ C/C ≤ 10%, Δ tanδ ≤ 0.001 at 1 kHz IR after test ≥ 50% of initial limit
Resistance to Soldering Heat Test	Test Conditions		Performances
	Solder bath temperature: Dipping time (with heat screen):	260°C ±5°C 10 seconds ±1 second	Δ C/C ≤ 2%

Environmental Compliance

All KEMET pulse capacitors are RoHS compliant.



Table 1 – Ratings & Part Number Reference

VDC	VAC	Cap Value (µF)	Dimensions in mm			Lead Spacing (S)	Ød (mm)	dV/dt (V/µs)	Max K ₀ (V ² /µs)	I _{pk}	ESL	ESR max	I _{rms} max (*)	R _{th}	KEMET Part Number	Customer Part Number
											Lead Length 2x4 mm	at 100 kHz	at 100 kHz, 85°C			
			A _{pk}	nH	mΩ						A _{rms}	(°C/W)				
450	160	0.10	4.0	9.0	13.0	10.0	0.6	150	135,000	15.0	9	199	1.1	79	71XF3100(1)H0(2)	R71XF3100(1)H0(2)
450	160	0.15	4.0	9.0	13.0	10.0	0.6	150	135,000	22.5	9	133	1.39	79	71XF3150(1)H0(2)	R71XF3150(1)H0(2)
450	160	0.22	5.0	11.0	13.0	10.0	0.6	150	135,000	33.0	9	90	1.79	69	71XF3220(1)H0(2)	R71XF3220(1)H0(2)
450	160	0.33	6.0	12.0	13.0	10.0	0.6	150	135,000	49.5	9	60	2.28	64	71XF3330(1)H0(2)	R71XF3330(1)H0(2)
450	160	0.47	6.0	12.0	13.0	10.0	0.6	150	135,000	70.5	9	42	2.72	64	71XF3470(1)H0(3)	R71XF3470(1)H0(3)
450	160	0.33	5.0	11.0	18.0	15.0	0.8	100	90,000	33.0	10	84	1.98	60	71XI3300(1)H0(2)	R71XI3300(1)H0(2)
450	160	0.47	6.0	12.0	18.0	15.0	0.8	100	90,000	47.0	10	59	2.46	56	71XI3470(1)H0(2)	R71XI3470(1)H0(2)
450	160	0.68	6.0	12.0	18.0	15.0	0.8	100	90,000	68.0	10	53	2.61	56	71XI3680(1)H0(2)	R71XI3680(1)H0(2)
450	160	1.0	7.5	13.5	18.0	15.0	0.8	100	90,000	100.0	10	36	3.32	51	71XI4100(1)H0(2)	R71XI4100(1)H0(2)
450	160	1.5	10.0	16.0	18.0	15.0	0.8	100	90,000	150.0	10	27	4.14	44	71XI4150(1)H0(2)	R71XI4150(1)H0(2)
450	160	2.2	11.0	19.0	18.0	15.0	0.8	100	90,000	220.0	10	18	5.24	40	71XI4220(1)H0(2)	R71XI4220(1)H0(2)
450	160	1.0	6.0	15.0	26.5	22.5	0.8	70	63,000	70.0	16	51	3.01	43	71XN4100(1)H0(2)	R71XN4100(1)H0(2)
450	160	1.5	7.0	16.0	26.5	22.5	0.8	70	63,000	105.0	16	34	3.79	41	71XN4150(1)H0(2)	R71XN4150(1)H0(2)
450	160	2.2	8.5	17.0	26.5	22.5	0.8	70	63,000	154.0	16	23	4.74	38	71XN4220(1)H0(2)	R71XN4220(1)H0(2)
450	160	3.3	10.0	18.5	26.5	22.5	0.8	70	63,000	231.0	16	15	6.02	36	71XN4330(1)H0(2)	R71XN4330(1)H0(2)
450	160	4.7	13.0	22.0	26.5	22.5	0.8	70	63,000	329.0	16	11	7.67	31	71XN4470(1)H0(2)	R71XN4470(1)H0(2)
450	160	2.2	9.0	17.0	32.0	27.5	0.8	50	45,000	110.0	18	29	4.45	35	71XR4220(1)H0(2)	R71XR4220(1)H0(2)
450	160	3.3	9.0	17.0	32.0	27.5	0.8	50	45,000	165.0	18	19	5.45	35	71XR4330(1)H0(2)	R71XR4330(1)H0(2)
450	160	4.7	11.0	20.0	32.0	27.5	0.8	50	45,000	235.0	18	14	6.86	31	71XR4470(1)H0(2)	R71XR4470(1)H0(2)
450	160	6.8	13.0	22.0	32.0	27.5	0.8	50	45,000	340.0	18	9	8.57	29	71XR4680(1)H0(2)	R71XR4680(1)H0(2)
450	160	10	14.0	28.0	32.0	27.5	0.8	50	45,000	500.0	18	10	8.68	26	71XR5100(1)H0(2)	R71XR5100(1)H0(2)
450	160	15	18.0	33.0	32.0	27.5	0.8	50	45,000	750.0	18	7	11.33	23	71XR5150(1)H0(2)	R71XR5150(1)H0(2)
450	160	22	22.0	37.0	32.0	27.5	0.8	50	45,000	1,100.0	18	7	11.78	21	71XR5220(1)H0(2)	R71XR5220(1)H0(2)
520	200	0.10	4.0	9.0	13.0	10.0	0.6	200	208,000	20.0	9	199	1.13	79	71VF3100(1)H6(2)	R71VF3100(1)H6(2)
520	200	0.15	5.0	11.0	13.0	10.0	0.6	200	208,000	30.0	9	133	1.48	69	71VF3150(1)H6(2)	R71VF3150(1)H6(2)
520	200	0.22	6.0	12.0	13.0	10.0	0.6	200	208,000	44.0	9	90	1.86	64	71VF3220(1)H6(2)	R71VF3220(1)H6(2)
520	200	0.33	5.0	11.0	18.0	15.0	0.8	140	145,600	30.8	10	127	1.62	60	71VI3220(1)H6(2)	R71VI3220(1)H6(2)
520	200	0.47	6.0	12.0	18.0	15.0	0.8	140	145,600	46.2	10	84	2.06	56	71VI3330(1)H6(2)	R71VI3330(1)H6(2)
520	200	0.68	6.0	12.0	18.0	15.0	0.8	140	145,600	65.8	10	59	2.46	56	71VI3470(1)H6(2)	R71VI3470(1)H6(2)
520	200	1.0	7.5	13.5	18.0	15.0	0.8	140	145,600	95.2	10	53	2.74	51	71VI3680(1)H6(2)	R71VI3680(1)H6(2)
520	200	1.5	10.0	16.0	18.0	15.0	0.8	140	145,600	140.0	10	36	3.56	44	71VI4100(1)H6(2)	R71VI4100(1)H6(2)
520	200	2.2	11.0	19.0	18.0	15.0	0.8	140	145,600	210.0	10	27	4.33	40	71VI4150(1)H6(2)	R71VI4150(1)H6(2)
520	200	3.3	13.0	22.0	18.0	15.0	0.8	85	88,400	329.0	16	11	7.67	31	71VN4100(1)H6(2)	R71VN4100(1)H6(2)
520	200	4.7	13.0	22.0	18.0	15.0	0.8	85	88,400	470.0	16	9	8.57	29	71VN4150(1)H6(2)	R71VN4150(1)H6(2)
VDC	VAC	Cap Value	T	H	L	Lead Spacing (S)	Ød (mm)	dV/dt (V/µs)	Max K ₀ (V ² /µs)	A _{pk}	Lead Length	at 100 kHz	at 100 kHz, 85°C	(°C/W)	KEMET Part Number	Customer Part Number
										I _{pk}	ESL	ESR	I _{rms} max (*)	R _{th}		

(1) Insert lead and packaging code. See table for available options.

(2) J=5%, K = 10%, M = 20%

(3) M = ±20% (only available tolerance)

(4) K = 10%, M = ±20% (only available tolerance)

Table 1 – Ratings & Part Number Reference cont.

VDC	VAC	Cap Value (µF)	Dimensions in mm			Lead Spacing (S)	Ød (mm)	dV/dt (V/µs)	Max K ₀ (V ² /µs)	I _{pk}	ESL	ESR max	I _{rms} max (*)	R _{th}	KEMET Part Number	Customer Part Number
											Lead Length 2x4 mm	at 100 kHz	at 100 kHz, 85°C			
			A _{pk}	nH	mΩ						A _{rms}	(°C/W)				
520	200	2.2	10.0	18.5	26.5	22.5	0.8	85	88,400	187.0	16	23	4.91	36	71VN4220(1)H6(2)	R71VN4220(1)H6(2)
520	200	3.3	13.0	22.0	26.5	22.5	0.8	85	88,400	280.5	16	15	6.43	31	71VN4330(1)H6(2)	R71VN4330(1)H6(2)
520	200	2.2	9.0	17.0	32.0	27.5	0.8	70	72,800	154.0	18	29	4.45	35	71VR4220(1)H6(2)	R71VR4220(1)H6(2)
520	200	3.3	11.0	20.0	32.0	27.5	0.8	70	72,800	231.0	18	19	5.75	31	71VR4330(1)H6(2)	R71VR4330(1)H6(2)
520	200	4.7	13.0	22.0	32.0	27.5	0.8	70	72,800	329.0	18	14	7.13	29	71VR4470(1)H6(2)	R71VR4470(1)H6(2)
520	200	6.8	14.0	28.0	32.0	27.5	0.8	70	72,800	476.0	18	9	9.05	26	71VR4680(1)H6(2)	R71VR4680(1)H6(2)
520	200	10	18.0	33.0	32.0	27.5	0.8	70	72,800	700.0	18	10	9.25	23	71VR5100(1)H6(2)	R71VR5100(1)H6(2)
520	200	15	22.0	37.0	32.0	27.5	0.8	70	72,800	1,050.0	18	7	11.91	21	71VR5150(1)H6(2)	R71VR5150(1)H6(2)
630	220	0.033	4.0	9.0	13.0	10.0	0.6	260	327,600	8.6	9	603	0.65	79	71PF2330(1)H6(2)	R71PF2330(1)H6(2)
630	220	0.047	4.0	9.0	13.0	10.0	0.6	260	327,600	12.2	9	423	0.78	79	71PF2470(1)H6(2)	R71PF2470(1)H6(2)
630	220	0.068	4.0	9.0	13.0	10.0	0.6	260	327,600	17.7	9	293	0.93	79	71PF2680(1)H6(2)	R71PF2680(1)H6(2)
630	220	0.10	5.0	11.0	13.0	10.0	0.6	260	327,600	26.0	9	199	1.21	69	71PF3100(1)H6(2)	R71PF3100(1)H6(2)
630	220	0.15	6.0	12.0	13.0	10.0	0.6	260	327,600	39.0	9	133	1.54	64	71PF3150(1)H6(2)	R71PF3150(1)H6(2)
630	220	0.22	6.0	12.0	13.0	10.0	0.6	260	327,600	57.2	9	90	1.86	64	71PF3220(1)H6(3)	R71PF3220(1)H6(3)
630	220	0.15	5.0	11.0	18.0	15.0	0.8	170	214,200	25.5	10	186	1.34	60	71PI3150(1)H6(2)	R71PI3150(1)H6(2)
630	220	0.22	5.0	11.0	18.0	15.0	0.8	170	214,200	37.4	10	127	1.62	60	71PI3220(1)H6(2)	R71PI3220(1)H6(2)
630	220	0.33	6.0	12.0	18.0	15.0	0.8	170	214,200	56.1	10	84	2.06	56	71PI3330(1)H6(2)	R71PI3330(1)H6(2)
630	220	0.47	7.5	13.5	18.0	15.0	0.8	170	214,200	79.9	10	59	2.58	51	71PI3470(1)H6(2)	R71PI3470(1)H6(2)
630	220	0.68	8.5	14.5	18.0	15.0	0.8	170	214,200	115.6	10	53	2.82	48	71PI3680(1)H6(2)	R71PI3680(1)H6(2)
630	220	1.0	11.0	19.0	18.0	15.0	0.8	170	214,200	170.0	10	36	3.73	40	71PI4100(1)H6(2)	R71PI4100(1)H6(2)
630	220	1.5	11.0	19.0	18.0	15.0	0.8	170	214,200	255.0	10	27	4.33	40	71PI4150(1)H6(4)	R71PI4150(1)H6(4)
630	220	0.68	6.0	15.0	26.5	22.5	0.8	110	138,600	74.8	16	75	2.48	43	71PN3680(1)H6(2)	R71PN3680(1)H6(2)
630	220	1.0	8.5	17.0	26.5	22.5	0.8	110	138,600	110.0	16	51	3.20	38	71PN4100(1)H6(2)	R71PN4100(1)H6(2)
630	220	1.5	10.0	18.5	26.5	22.5	0.8	110	138,600	165.0	16	34	4.06	36	71PN4150(1)H6(2)	R71PN4150(1)H6(2)
630	220	2.2	11.0	20.0	26.5	22.5	0.8	110	138,600	242.0	16	23	5.04	34	71PN4220(1)H6(2)	R71PN4220(1)H6(2)
630	220	3.3	13.0	22.0	26.5	22.5	0.8	110	138,600	363.0	16	15	6.43	31	71PN4330(1)H6(2)	R71PN4330(1)H6(2)
630	220	1.5	9.0	17.0	32.0	27.5	0.8	80	100,800	120.0	18	42	3.67	35	71PR4150(1)H6(2)	R71PR4150(1)H6(2)
630	220	2.2	11.0	20.0	32.0	27.5	0.8	80	100,800	176.0	18	29	4.69	31	71PR4220(1)H6(2)	R71PR4220(1)H6(2)
630	220	3.3	13.0	22.0	32.0	27.5	0.8	80	100,800	264.0	18	19	5.97	29	71PR4330(1)H6(2)	R71PR4330(1)H6(2)
630	220	4.7	13.0	25.0	32.0	27.5	0.8	80	100,800	376.0	18	14	7.30	28	71PR4470(1)H6(4)	R71PR4470(1)H6(4)
630	220	6.8	16.0	30.0	32.0	27.5	0.8	80	100,800	544.0	18	9	9.33	25	71PR4680(1)H6(2)	R71PR4680(1)H6(2)
630	220	10	22.0	37.0	32.0	27.5	0.8	80	100,800	800.0	18	10	9.73	21	71PR5100(1)H6(2)	R71PR5100(1)H6(2)
VDC	VAC	Cap Value	T	H	L	Lead Spacing (S)	Ød (mm)	dV/dt (V/µs)	Max K ₀ (V ² /µs)	A _{pk}	Lead Length	at 100 kHz	at 100 kHz, 85°C	(°C/W)	KEMET Part Number	Customer Part Number
										I _{pk}	ESL	ESR	I _{rms} max (*)	R _{th}		

- (1) Insert lead and packaging code. See table for available options.
- (2) J=5%, K = 10%, M = 20%
- (3) M = ±20% (only available tolerance)
- (4) K = 10%, M = ±20% (only available tolerance)

Soldering Process

The implementation of the RoHS directive has resulted in the selection of SnAgCu (SAC) alloys or SnCu alloys as primary solder. This has increased the liquidus temperature from that of 183°C for SnPb eutectic alloy to 217 – 221°C for the new alloys. As a result, the heat stress to the components, even in wave soldering, has increased considerably due to higher pre-heat and wave temperatures. Polypropylene capacitors are especially sensitive to heat (the melting point of polypropylene is 160 – 170°C). Wave soldering can be destructive, especially for mechanically small polypropylene capacitors (with lead spacing of 5 mm to 15 mm), and great care has to be taken during soldering. The recommended solder profiles from KEMET should be used. Please consult KEMET with any questions. In general, the wave soldering curve from IEC Publication 61760–1 Edition 2 serves as a solid guideline for successful soldering. Please see Figure 1.

Reflow soldering is not recommended for through-hole film capacitors. Exposing capacitors to a soldering profile in excess of the above recommended limits may result in degradation or permanent damage to the capacitors.

Do not place the polypropylene capacitor through an adhesive curing oven to cure resin for surface mount components. Insert through-hole parts after the curing of surface mount parts. Consult KEMET to discuss the actual temperature profile in the oven, if through-hole components must pass through the adhesive curing process. A maximum two soldering cycles is recommended. Please allow time for the capacitor surface temperature to return to a normal temperature before the second soldering cycle.

Manual Soldering Recommendations

Following is the recommendation for manual soldering with a soldering iron.

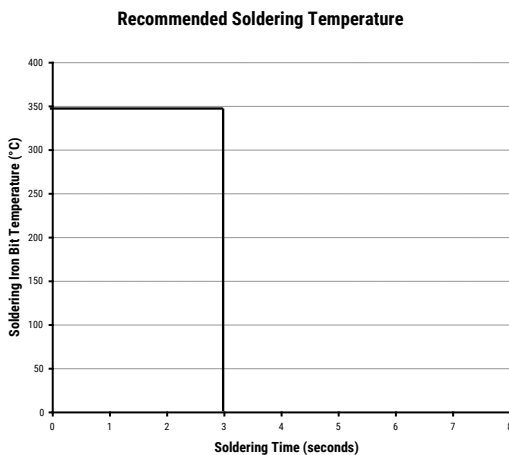

The soldering iron tip temperature should be set at 350°C (+10°C maximum) with the soldering duration not to exceed more than 3 seconds.

Wave Soldering Recommendations

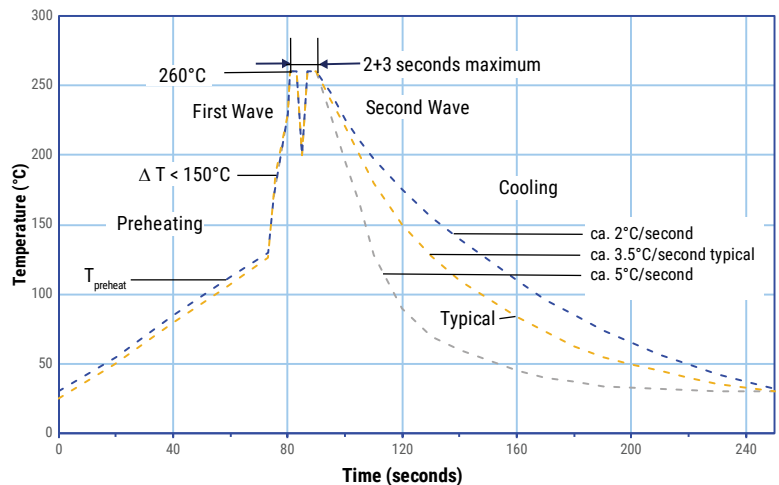

Soldering Process cont.

Wave Soldering Recommendations cont.

1. The table indicates the maximum set-up temperature of the soldering process

Figure 1

Film Material	Maximum Preheat Temperature		Maximum Peak Soldering Temperature	
	Capacitor Pitch ≤ 15 mm	Capacitor Pitch > 15 mm	Capacitor Pitch ≤ 15 mm	Capacitor Pitch > 15 mm
Single Metallized HT Polypropylene	125°C	130°C	260°C	270°C

2. The maximum temperature measured on the capacitor body:

Set the temperature so that the maximum temperature is below the limit:

Film Material	Maximum Temperature Measured on the Capacitor Body
Single Metallized Polypropylene	120°C (for series R71H)

Duration: < 60 seconds

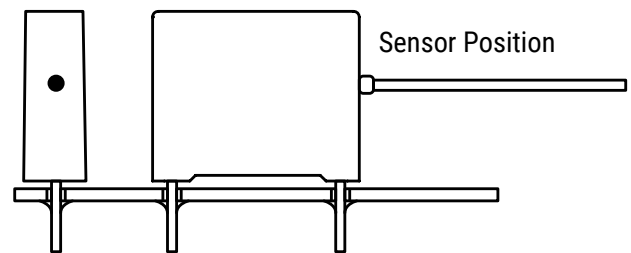

Selective Soldering Recommendations

Selective dip soldering is a variation of reflow soldering. In this method, the printed circuit board with through-hole components to be soldered is preheated and transported over the solder bath as in normal flow soldering without touching the solder. When the board is over the bath, it is stopped and pre-designed solder pots are lifted from the bath with molten solder only at the places of the selected components, and pressed against the lower surface of the board to solder the components.

The temperature profile for selective soldering is similar to the double wave flow soldering outlined in this document, **however, instead of two baths, there is only one bath with a time from 3 to 10 seconds.** In selective soldering, the risk of overheating is greater than in double wave flow soldering, and great care must be taken so that the parts are not overheated.

Mounting

Resistance to Vibration and Mechanical Shock

AEC-Q200 Mechanical Stress Tests:

Mechanical Shock	MIL-STD-202 Method 213	Test condition C Peak value 100 g, duration 6 ms, half-sine-wave (see MIL-HDBK for details)
Vibration	MIL-STD-202 Method 204	5 g for 20 minutes, 12 cycles each of 3 orientations Use 8"X5" PCB, 0.031" thick. 7 secure points on one 8" side and 2 secure points at corners of opposite sides. Parts mounted within 2" from any secure point. Test from 10 – 2,000 Hz.

The capacitors are designed for PCB mounting. The stand-off pipes must be in good contact with the printed circuit board. The capacitors with pitch ≤ 22.5 mm can be mechanically fixed by the leads, for pitch > 22.5 mm, the capacitor body has to be properly fixed (e.g. clamped or glued).

Construction

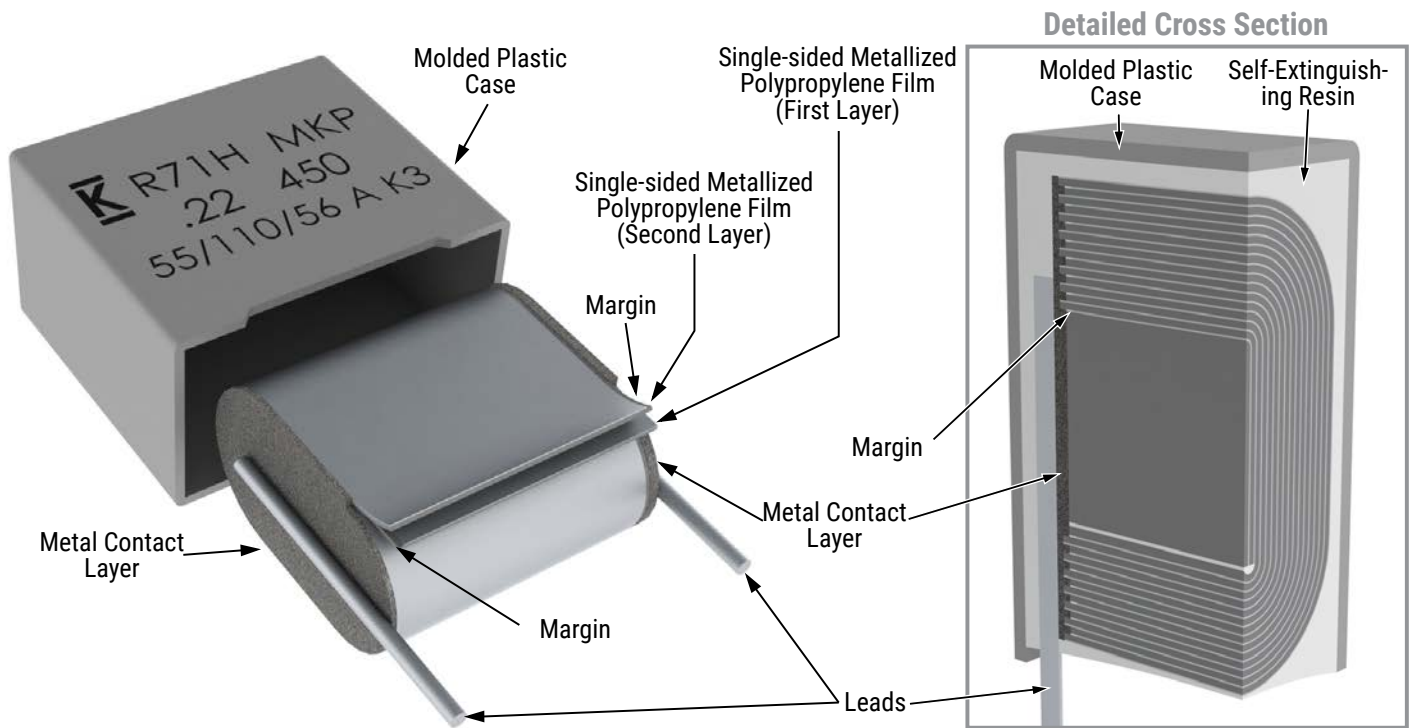

Winding Scheme

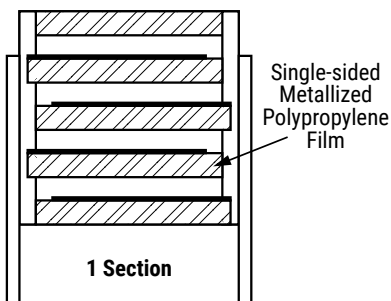

Marking

Pitch – 10, 15 & 22.5

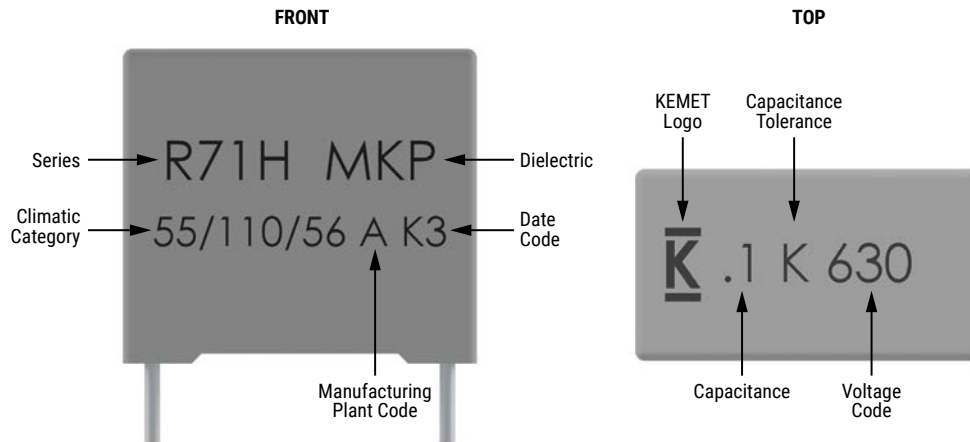

Pitch – 10, 15 & 22.5 Alternatives*

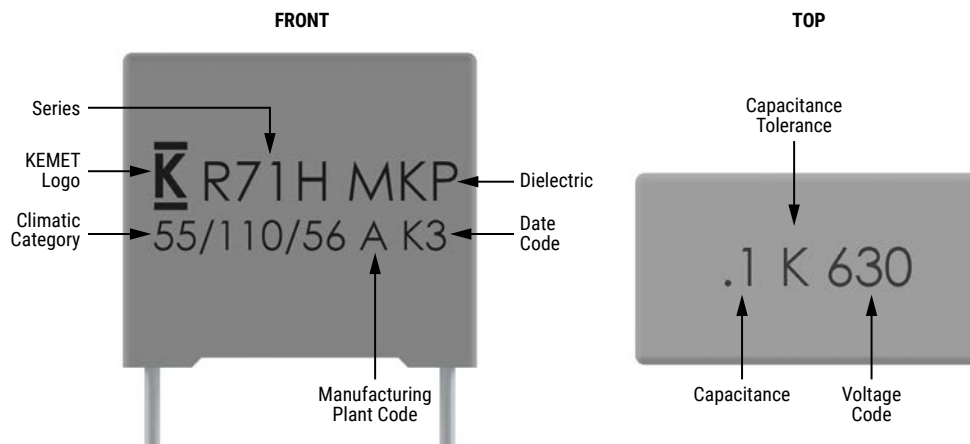

Pitch – 10, 15 & 22.5 Alternatives*

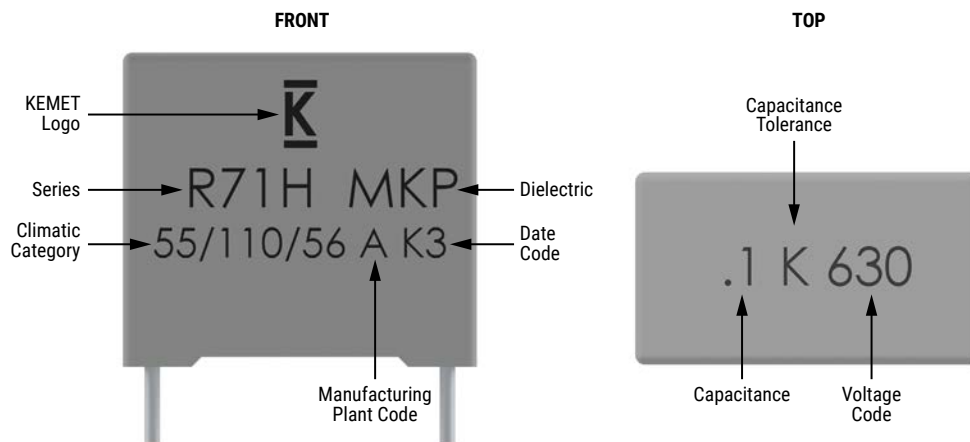

* Differences are caused by technology (clichee, laser or ink jet) and technic (production line).

Marking cont.

Pitch – 10, 15, 22.5 Alternatives* & 27.5

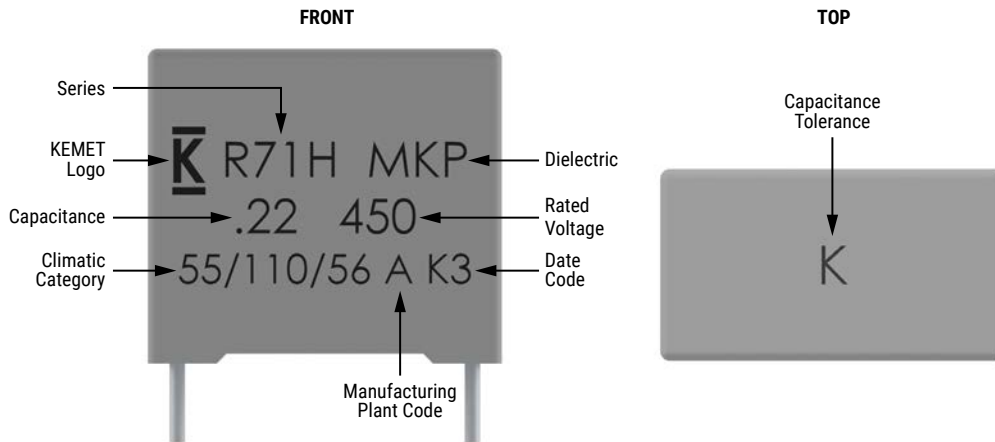

Pitch – 27.5 Alternatives*

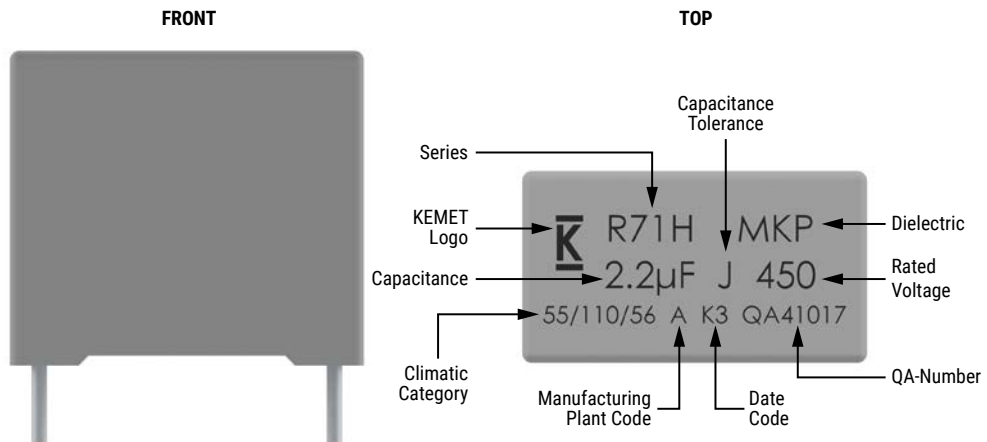

* Differences are caused by technology (clichee, laser, or ink) and technic (production line)

Manufacturing Date Code (IEC-60062)							
Year	Code	Year	Code	Month	Code	Month	Code
2010	A	2020	M	January	1	July	7
2011	B	2021	N	February	2	August	8
2012	C	2022	P	March	3	September	9
2013	D	2023	R	April	4	October	0
2014	E	2024	S	May	5	November	N
2015	F	2025	T	June	6	December	D
2016	H	2026	U				
2017	J	2027	V				
2018	K	2028	W				
2019	L	2029	X				

Packaging Quantities

Lead Spacing	Thickness (mm)	Height (mm)	Length (mm)	Bulk Short Leads	Bulk Long Leads		Standard Reel ø 355 mm	Large Reel ø 500 mm	Ammo Taped
	Lead and Packaging Code			AA – JB JE – JH	JM	40 – 50	GY	CK	DQ
10	4.0	9.0	13.0	2,000	2,200	1,800	750	1,500	1,000
	5.0	11.0	13.0	1,300	2,000	1,500	600	1,250	800
	6.0	12.0	13.0	1,000	1,800	1,200	500	1,000	680
15	5.0	11.0	18.0	2,000	1,250	1,000	600	1,250	800
	6.0	12.0	18.0	1,750	1,000	900	500	1,000	680
	6.0	17.5	18.0	1,000	800	700	500	1,000	680
	7.5	13.5	18.0	1,000	800	700	350	800	500
	7.5	18.5	18.0	900	650	500	350	800	500
	8.5	14.5	18.0	1,000	650	500	300	700	440
	9.0	12.5	18.0	1,000	700	520	270	650	410
	10.0	16.0	18.0	750	550	500	270	600	380
	11.0	19.0	18.0	450	400	350	270	500	340
	13.0	12.0	18.0	750	520	490	200	480	280
22.5	6.0	15.0	26.5	805	450	500	300	700	464
	7.0	16.0	26.5	700	450	500	250	550	380
	8.5	17.0	26.5	468	350	300	250	450	280
	10.0	18.5	26.5	396	350	300	160	350	235
	11.0	20.0	26.5	360	200	250	160	350	217
	13.0	22.0	26.5	300	150	200	130	300	-
27.5	9.0	17.0	32.0	816	-	408	230	450	-
	11.0	20.0	32.0	560	-	336	190	350	-
	13.0	12.0	32.0	672	-	288	-	-	-
	13.0	22.0	32.0	480	-	288	150	300	-
	13.0	25.0	32.0	480	-	288	-	300	-
	14.0	28.0	32.0	352	-	176	-	-	-
	16.0	30.0	32.0	288	-	144	-	-	-
	18.0	33.0	32.0	256	-	128	-	-	-
	22.0	37.0	32.0	168	-	112	-	-	-
	24.0	15.0	32.0	336	-	144	-	-	-

Lead Taping & Packaging (IEC 60286-2)

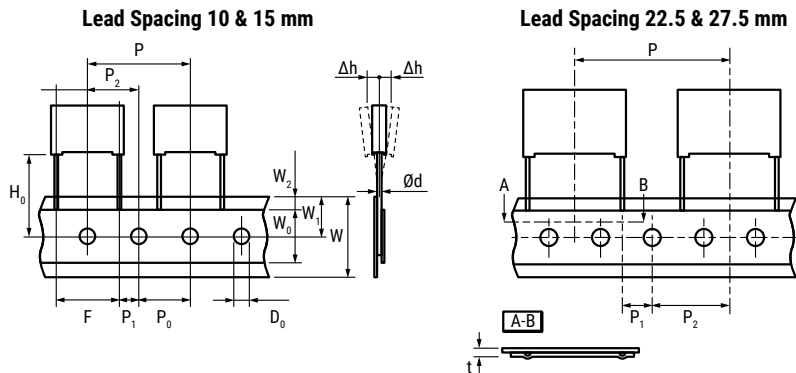

Taping Specification

Description	Symbol	Dimensions (mm)					Tolerance
		Lead Spacing					
		10.0	15.0	22.5	27.5		
Lead wire diameter	d	0.6	0.6 – 0.8	0.8	0.8	±0.05	
Taping lead space	P	25.4	25.4	38.1	38.1	±1	
Feed hole lead space *	P ₀	12.7	12.7	12.7	12.7	±0.2 **	
Centering of the lead wire	P ₁	7.7	5.2	7.8	5.3	±0.7	
Centering of the body	P ₂	12.7	12.7	19.05	19.05	±1.3	
Lead spacing ***	F	10.0	15.0	22.5	27.5	+0.6/-0.1	
Component alignment	Δh	0	0	0	0	±2	
Component deviation	Δp	0	0	0	0	±1	
Height of component from tape center	H ₀ ****	18.5	18.5	18.5	18.5	±0.5	
Carrier tape width	W	18	18	18	18	+1/-0.5	
Hold down tape width	W ₀	9	10	10	10	Minimum	
Hole position	W ₁	9	9	9	9	±0.5	
Hold down tape position	W ₂	3	3	3	3	Maximum	
Feed hole diameter	D ₀	4	4	4	4	±0.2	
Total tape thickness	t	0.7	0.7	0.7	0.7	±0.2	

* Available also 15 mm.

** Maximum 1 mm on 20 lead spacing.

*** 15 mm and 10 mm taped to 7.5 mm (crimped leads) available upon request.

**** H₀ = 16.5 mm is available upon request.

Lead Taping & Packaging (IEC 60286-2) cont.

Ammo Specifications

Dimensions (mm)		
H	W	T
360	340	59

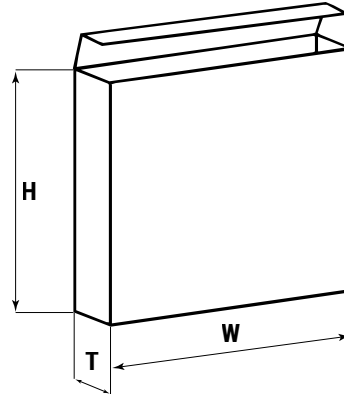

Reel Specifications

Dimensions (mm)		
D	H	W
355	30	55 Maximum
500	25	

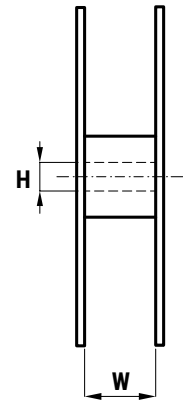
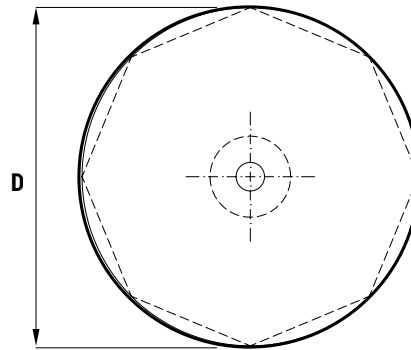

KEMET Electronics Corporation Sales Offices

For a complete list of our global sales offices, please visit www.kemet.com/sales.

Disclaimer

All product specifications, statements, information and data (collectively, the "Information") in this datasheet are subject to change. The customer is responsible for checking and verifying the extent to which the Information contained in this publication is applicable to an order at the time the order is placed. All Information given herein is believed to be accurate and reliable, but it is presented without guarantee, warranty, or responsibility of any kind, expressed or implied.

Statements of suitability for certain applications are based on KEMET Electronics Corporation's ("KEMET") knowledge of typical operating conditions for such applications, but are not intended to constitute – and KEMET specifically disclaims – any warranty concerning suitability for a specific customer application or use. The Information is intended for use only by customers who have the requisite experience and capability to determine the correct products for their application. Any technical advice inferred from this Information or otherwise provided by KEMET with reference to the use of KEMET's products is given gratis, and KEMET assumes no obligation or liability for the advice given or results obtained.

Although KEMET designs and manufactures its products to the most stringent quality and safety standards, given the current state of the art, isolated component failures may still occur. Accordingly, customer applications which require a high degree of reliability or safety should employ suitable designs or other safeguards (such as installation of protective circuitry or redundancies) in order to ensure that the failure of an electrical component does not result in a risk of personal injury or property damage.

Although all product-related warnings, cautions and notes must be observed, the customer should not assume that all safety measures are indicated or that other measures may not be required.

KEMET is a registered trademark of KEMET Electronics Corporation.

单击下面可查看定价，库存，交付和生命周期等信息

[>>KEMET\(基美\)](#)