

T510 Space, Tantalum, MnO2 Tantalum, Space Multi-Anode, 330 uF, 20%, 10 VDC, SMD, MnO2, Molded, Aerospace, Low ESR, Multi-Anode, 35 mOhms, 7343, Height Max = 4.3mm

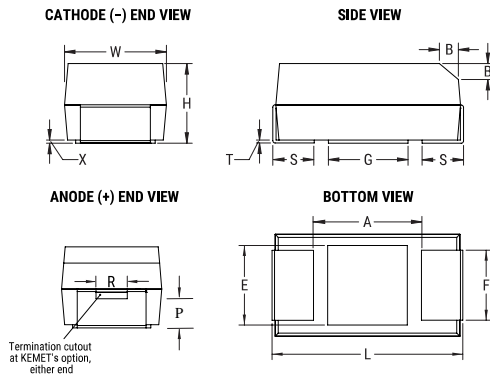

Dimensions	
Footprint	7343
L	7.3mm +/-0.3mm
W	4.3mm +/-0.3mm
H	4mm +/-0.3mm
T	0.13mm REF
S	1.3mm +/-0.3mm
F	2.4mm +/-0.1mm
A	3.8mm MIN
B	0.5mm +/-0.15mm
E	3.5mm REF
G	3.5mm REF
P	1.7mm REF
R	1mm REF
X	0.1mm +/-0.1mm

Packaging Specifications	
Packaging:	T&R, 178mm
Packaging Quantity:	500

General Information	
Series:	T510 Space
Dielectric:	MnO2 Tantalum
Style:	SMD Chip
Description:	SMD, MnO2, Molded, Aerospace, Low ESR, Multi-Anode
Features:	Multiple Anode, Low ESR, Aerospace
RoHS:	No
Prop 65:	<b>WARNING:</b> Cancer and reproductive harm - <a href="http://www.p65warnings.ca.gov">www.p65warnings.ca.gov</a>
SCIP Number:	b064b03e-bd75-42af-b342-1fe94dec2340
Termination:	Solder Coated
AEC-Q200:	No
Component Weight:	430.15 mg

Specifications	
Capacitance:	330 uF
Capacitance Tolerance:	20%
Voltage DC:	10 VDC (85C), 6.7 VDC (125C)
Temperature Range:	-55/+125°C
Rated Temperature:	85°C
Dissipation Factor:	6% 120Hz 20C
Failure Rate:	C (0.01%/1000 Hrs)
Resistance:	35 mOhms (100kHz 20C)
Ripple Current:	2800 mA (100kHz 25C), 2520 mA (100kHz 85C), 1120 mA (100kHz 125C)
Leakage Current:	33 uA (5min 20°C)

Statements of suitability for certain applications are based on our knowledge of typical operating conditions for such applications, but are not intended to constitute - and we specifically disclaim - any warranty concerning suitability for a specific customer application or use. This Information is intended for use only by customers who have the requisite experience and capability to determine the correct products for their application. Any technical advice inferred from this Information or otherwise provided by us with reference to the use of our products is given gratis, and we assume no obligation or liability for the advice given or results obtained.

单击下面可查看定价，库存，交付和生命周期等信息

[>>KEMET\(基美\)](#)