

KONNEKT Auto COG, Ceramic, 3000 pF, 10%, 2000 VDC, COG

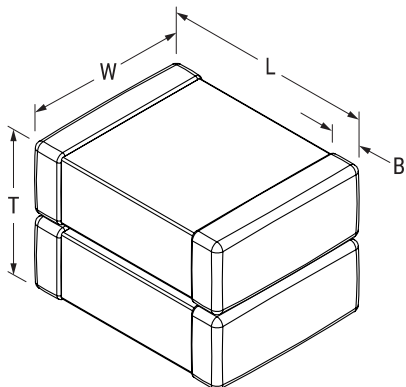

Dimensions

L	4.5mm +/-0.3mm
W	3.2mm +/-0.3mm
T	5.1mm +/-0.4mm
B	0.6mm +/-0.35mm

Packaging Specifications

Packaging:	T&R, 180mm, Plastic Tape
Packaging Quantity:	200

General Information

Series:	KONNEKT Auto COG
Style:	KONNEKT
Description:	SMD, MLCC, KONNEKT, Ultra-Stable, Class I
Features:	High Density Packaging
RoHS:	Yes
Termination:	Tin
Qualifications:	AEC-Q200
AEC-Q200:	Yes
Component Weight:	300 mg
Chip Size:	1812-2
Shelf Life:	78 Weeks
MSL:	1

Specifications

Capacitance:	3000 pF
Measurement Condition:	1 kHz 1.0Vrms
Capacitance Tolerance:	10%
Voltage DC:	2000 VDC
Dielectric Withstanding Voltage:	2400 VDC
Temperature Range:	-55/+125°C
Temperature Coefficient:	COG
Capacitance Change with Reference to +25°C and 0 VDC Applied (TCC):	30 ppm/C
Dissipation Factor:	0.1% 1 kHz 1.0Vrms
Aging Rate:	0% Loss/Decade Hour
Insulation Resistance:	100 GOhms

Statements of suitability for certain applications are based on our knowledge of typical operating conditions for such applications, but are not intended to constitute - and we specifically disclaim - any warranty concerning suitability for a specific customer application or use. This Information is intended for use only by customers who have the requisite experience and capability to determine the correct products for their application. Any technical advice inferred from this Information or otherwise provided by us with reference to the use of our products is given gratis, and we assume no obligation or liability for the advice given or results obtained.

单击下面可查看定价，库存，交付和生命周期等信息

[>>KEMET\(基美\)](#)