

Overview

The KEMET SN coils are normal mode choke coils with a wide variety of characteristics. These coils are designed with our proprietary Fe dust cores and are useful in various noise countermeasure fields.

Applications

- Home appliances
- Power supplies

Benefits

- Proprietary Fe dust core material
- Excellent for normal mode noise countermeasures
- Large core loss
- Wide variety of sizes and specifications
- Operating temperature range from -25°C to $+105^{\circ}\text{C}$



Part Number System

SN	10-		300	
Series	Dimension Code (See Dimensions)		Specification Code (See Table 1)	Core Orientation
SN	3	12P	3 digits or 4 digits	Blank = Vertical H = Horizontal
	5	13	Examples:	
	8S	14		
	8D	14P	3 digits: 300, 400, etc. 4 digits: 1700, 5501, etc.	
	10	16		
	10P	16P		
	12	20P		
	12HP			

Dimensions – Millimeters

Figure 1

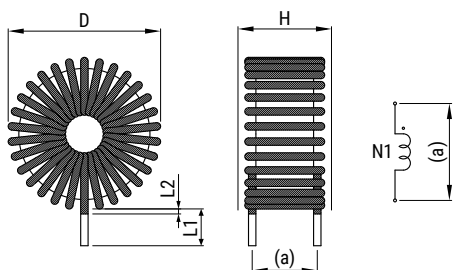

Figure 2

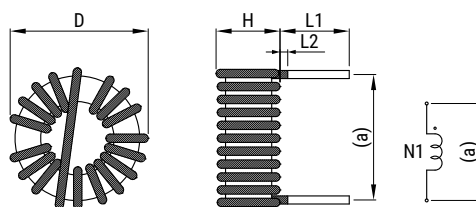
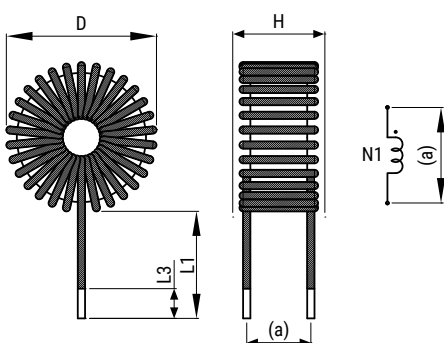

Figure 3



Part Number	Dimensions (mm)					Pin Pitch ¹ (Reference)	Figure
	D (Maximum)	H (Maximum)	L1	L2 (Maximum)	L3 (Maximum)	a	
SN3-300	8.5	5.5	20.0±2.0	2.0	–	5.0	Fig. 1
SN5-700	13.0	8.0	20.0±2.0	1.5	–	6.0	Fig. 1
SN3-200	8.5	5.5	20.0±2.0	1.5	–	5.0	Fig. 1
SN5-5501	13.0	7.0	20.0±2.0	1.6	–	7.0	Fig. 1
SN5-1700	14.0	8.0	20.0±2.0	1.5	–	6.0	Fig. 1
SN5-300	13.0	7.0	20.0±2.0	1.5	–	6.0	Fig. 1
SN5-400	13.0	8.0	20.0±2.0	1.5	–	6.0	Fig. 1
SN8S-300	16.0	8.0	20.0±2.0	1.5	–	8.0	Fig. 1
SN8S-400	16.0	8.0	20.0±2.0	1.5	–	8.0	Fig. 1
SN8S-500	16.0	9.0	20.0±2.0	1.5	–	8.5	Fig. 1
SN8D-300	16.0	11.0	20.0±2.0	1.5	–	9.5	Fig. 1
SN8D-400	16.0	11.0	20.0±2.0	1.5	–	10.0	Fig. 1
SN8D-500	17.0	13.0	20.0±2.0	1.5	–	10.5	Fig. 1
SN10P-800	22.0	12.0	10.0±2.0	1.5	–	10.0	Fig. 1
SN3-100	8.8	5.5	10.0±2.0	1.5	–	5.5	Fig. 1
SN10-300	21.0	11.0	20.0±2.0	1.5	–	9.0	Fig. 1
SN10-400	21.0	11.0	20.0±2.0	1.5	–	9.0	Fig. 1
SN10-500	21.0	12.0	20.0±2.0	1.5	–	10.0	Fig. 1
SN14P-770H	34.0	18.7	6.5±2.0	1.5	–	30.0	Fig. 2
SN8S-130	18.0	9.0	20.0±2.0	–	6 ±1	7.0	Fig. 3

¹ Pin pitch listed above for reference only. Values not guaranteed.

Dimensions – Millimeters cont.

Figure 1

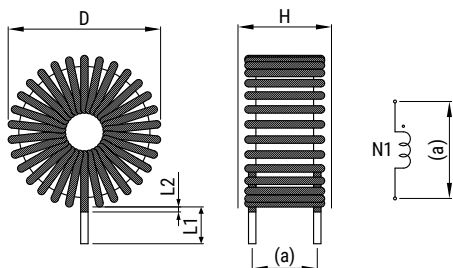

Figure 2

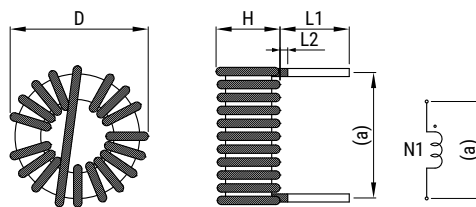
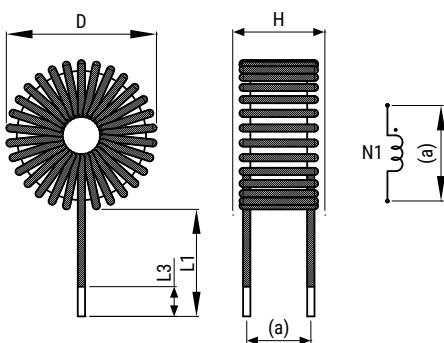

Figure 3



Part Number	Dimensions (mm)					Pin Pitch ¹ (Reference)	Figure
	D (Maximum)	H (Maximum)	L1	L2 (Maximum)	L3 (Maximum)	a	
SN12-300	25.0	12.0	20.0±2.0	1.5	–	10.0	Fig. 1
SN12-400	25.0	12.0	20.0±2.0	1.5	–	11.0	Fig. 1
SN12-500	26.0	12.0	20.0±2.0	1.5	–	12.0	Fig. 1
SN12P-500	26.0	13.0	20.0±2.0	1.5	–	12.0	Fig. 1
SN14-400	35.0	20.0	20.0±2.0	1.5	–	15.0	Fig. 1
SN12-6501	26.0	13.0	20.0±2.0	1.5	–	9.0	Fig. 1
SN12-800	28.0	15.0	20.0±2.0	2.0	–	10.0	Fig. 1
SN14-700	35.0	20.0	20.0±2.0	3.0	–	15.0	Fig. 1
SN13-300	30.0	17.0	20.0±2.0	1.5	–	16.0	Fig. 1
SN13-400	30.0	18.0	20.0±2.0	1.5	–	16.0	Fig. 1
SN13-500	31.0	18.0	20.0±2.0	1.5	–	16.5	Fig. 1
SN16-300	34.0	19.0	20.0±2.0	1.5	–	15.0	Fig. 1
SN16-400	35.0	19.0	20.0±2.0	1.5	–	15.0	Fig. 1
SN16-500	35.0	21.0	20.0±2.0	1.5	–	16.5	Fig. 1
SN16P-130	36.0	19.0	15.0±2.0	1.5	–	15.5	Fig. 1
SN12HP-2201	26.0	16.0	4.0±1.0	1.5	–	10.0	Fig. 1
SN20P-240	42.0	22.0	20.0±2.0	1.5	–	15.0	Fig. 1
SN20P-120H	45.0	38.0	5.0±1.5	1.5	–	38.0	Fig. 2

¹ Pin pitch listed above for reference only. Values not guaranteed.

Environmental Compliance

All KEMET AC Line Filters are RoHS Compliant.



Performance Characteristics

Item	Performance Characteristics
Rated Current Range	1 – 20 A
Rated Inductance Range	2.5 – 550 μ H minimum
Inductance Measurement Condition	100 kHz
Wire Type	1 PVF, 1 UEW, and 1 PEW
Thermal Class	A (105°C)
Operating Temperature Range	-25°C to +105°C (include self temperature rise)

Table 1 – Ratings & Part Number Reference

Part Number	Rated Current (A)	Inductance (µH) Minimum	DC Resistance/ Line (mΩ) Maximum	Temperature Rise (K) Maximum	Wire Diameter (mm)	Weight (g) Approximate
SN3-300	0.5	20.0	0.150	45	0.30	0.8
SN5-700	0.9	140.0	0.250	25	0.35	2.6
SN3-200	1.0	10.0	0.045	15	0.40	0.8
SN5-5501	1.0	80.0	0.200	45	0.40	2.6
SN5-1700	2.0	12.0	0.048	45	0.55	2.4
SN5-300	2.0	25.0	0.042	18	0.55	2.6
SN5-400	2.0	48.0	0.058	22	0.55	3.0
SN8S-300	2.0	26.0	0.042	19	0.60	4.1
SN8S-400	2.0	46.0	0.052	20	0.60	4.5
SN8S-500	2.0	72.0	0.068	23	0.60	4.9
SN8D-300	2.0	45.0	0.052	20	0.60	6.1
SN8D-400	2.0	80.0	0.072	24	0.60	6.8
SN8D-500	2.0	125.0	0.100	27	0.60	7.3
SN10P-800	2.5	297.0	0.190	50	0.60	12.5
SN3-100	3.0	2.5	0.025	45	0.45	0.7
SN10-300	3.0	40.0	0.035	18	0.80	10.2
SN10-400	3.0	72.0	0.042	20	0.80	10.8
SN10-500	3.0	110.0	0.052	26	0.80	11.8
SN14P-770H	3.0	550.0	0.085	35	1.00	54.0
SN8S-130	5.0	4.0	0.012	40	1.10	10.6
SN12-300	5.0	36.0	0.02	30	1.00	14.4
SN12-400	5.0	64.0	0.032	32	1.00	15.8
SN12-500	5.0	100.0	0.040	34	1.00	18.2
SN12P-500	5.0	100.0	0.040	40	1.00	19.5
SN14-400	5.0	120.0	0.045	40	1.20	48.4
SN12-6501	5.0	170.0	0.060	55	1.00	21.0
SN12-800	5.0	250.0	0.060	45	1.00	23.7
SN14-700	5.0	450.0	0.120	60	1.00	51.4
SN13-300	6.0	51.0	0.023	28	1.20	31.1
SN13-400	6.0	92.0	0.030	33	1.20	35.1
SN13-500	6.0	143.0	0.036	38	1.20	38.2
SN16-300	8.0	60.0	0.021	21	1.50	39.0
SN16-400	8.0	108.0	0.027	24	1.50	44.4
SN16-500	8.0	168.0	0.031	36	1.50	51.2
SN16P-130	10.0	10.0	0.005	45	1.80	35.8
SN12HP-2201	10.0	20.0	0.013	50	1.40	22.4
SN20P-240	20.0	40.0	0.010	55	2.00	70.0
SN20P-120H	20.0	120.0	0.018	65	2.10	153.7

Frequency Characteristics

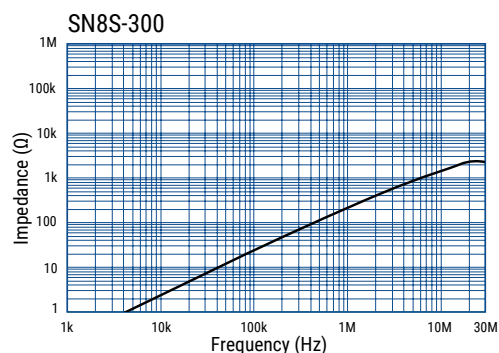
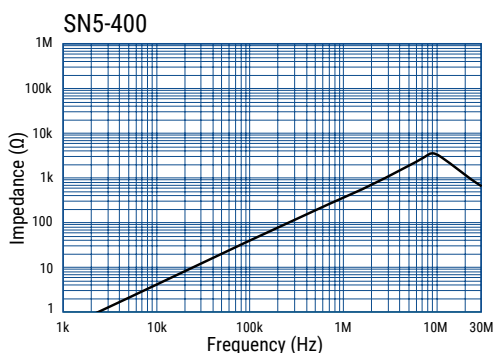
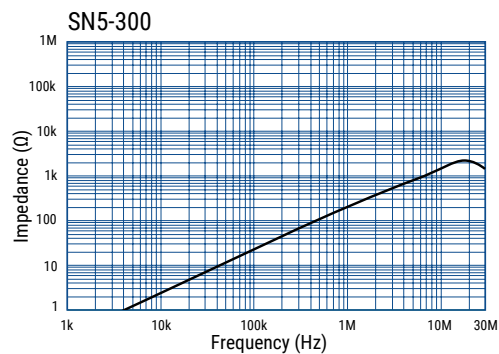
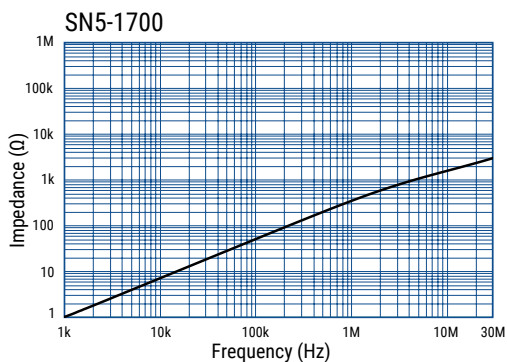
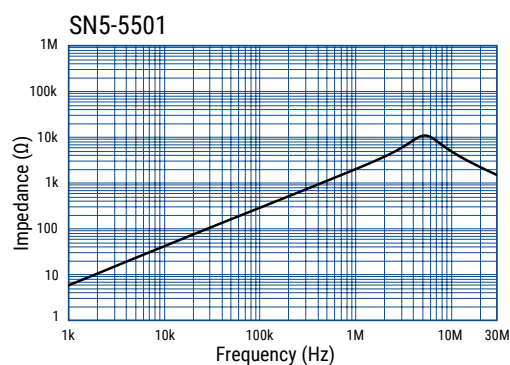
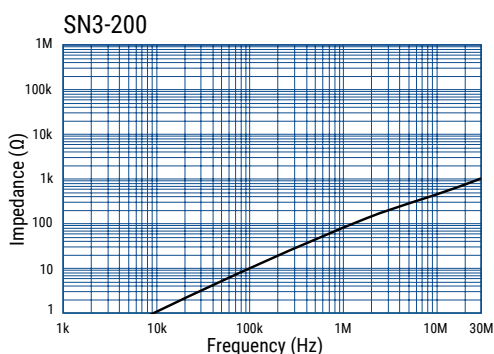
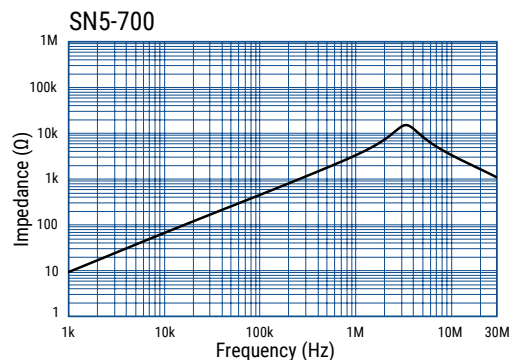
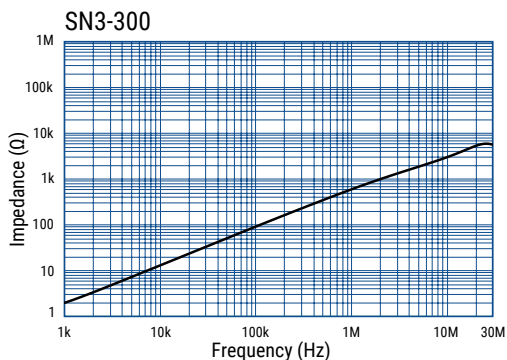

Frequency Characteristics cont.

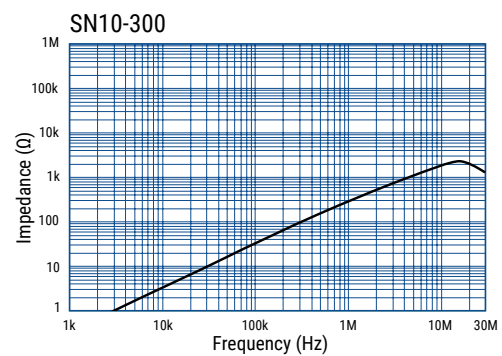
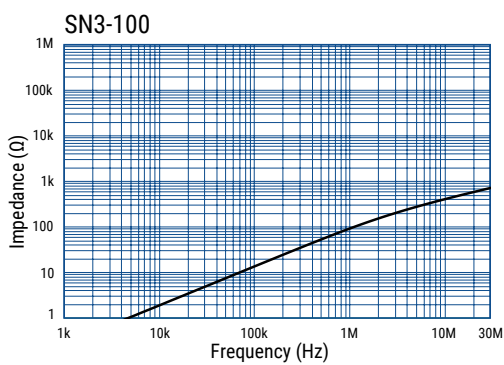
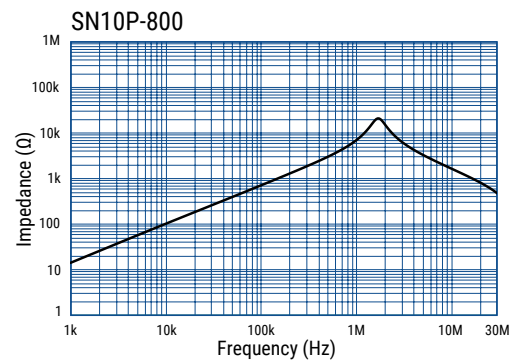
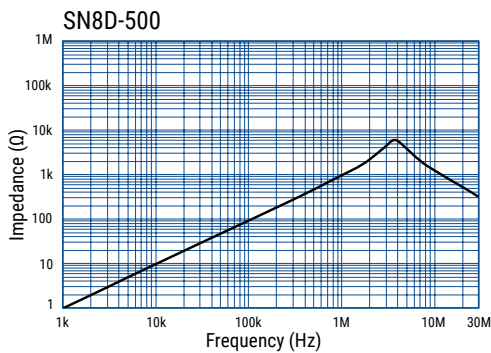
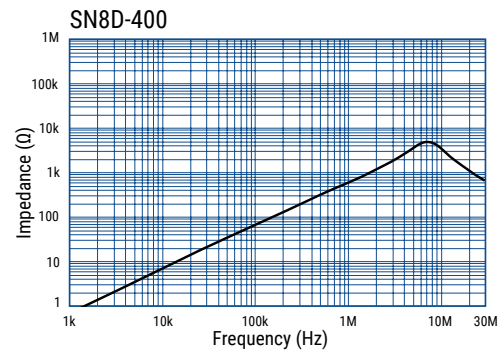
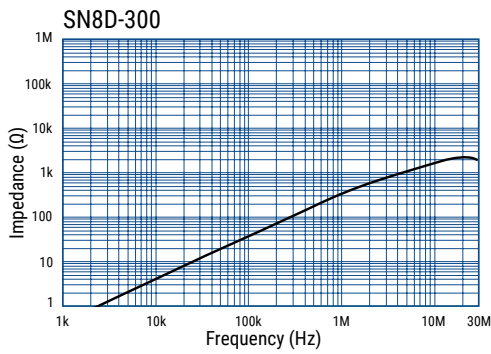
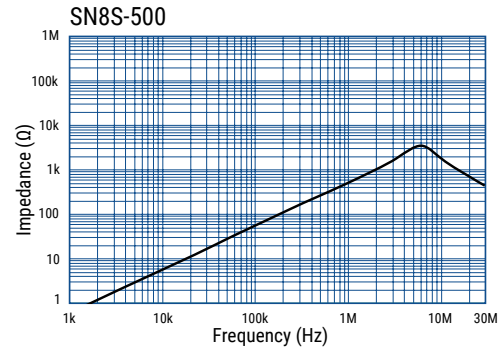
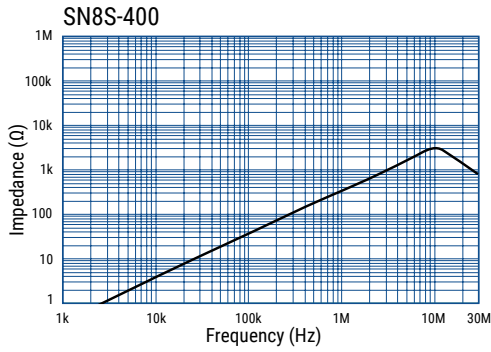

Frequency Characteristics cont.

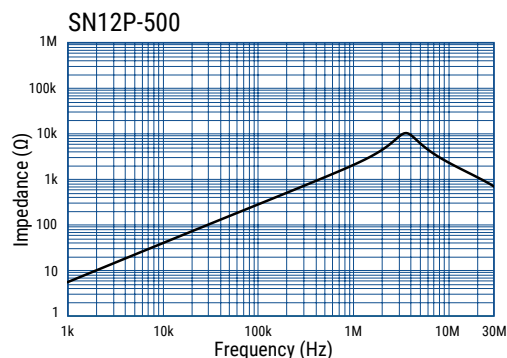
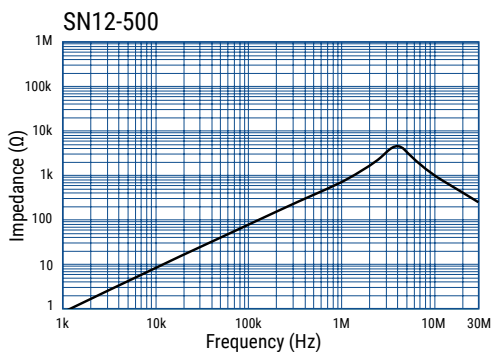
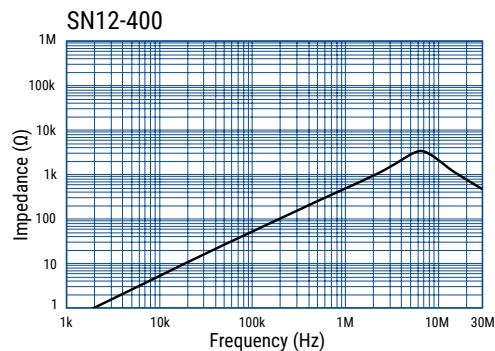
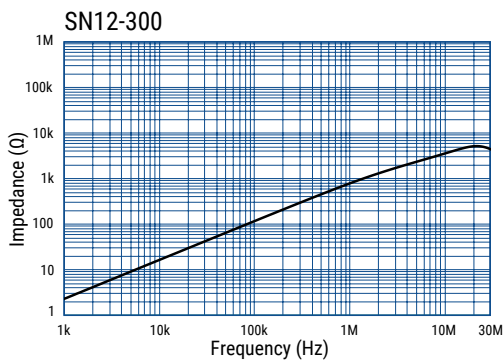
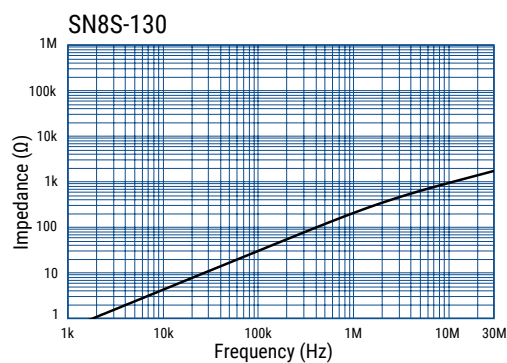
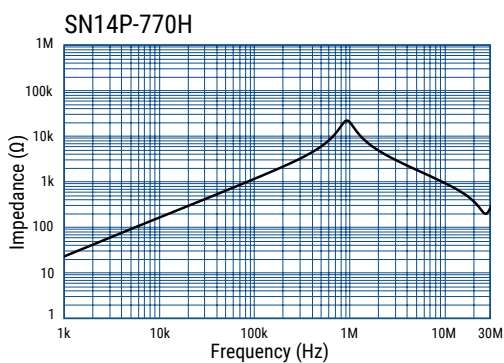
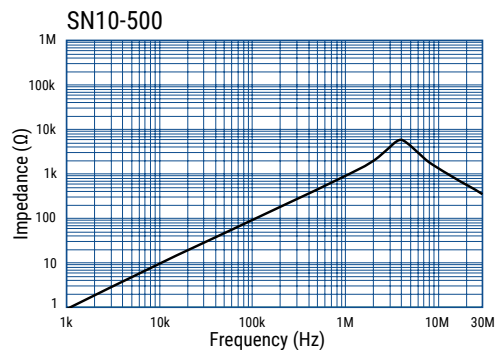
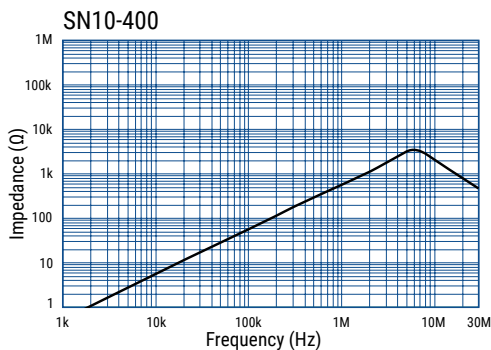

Frequency Characteristics cont.

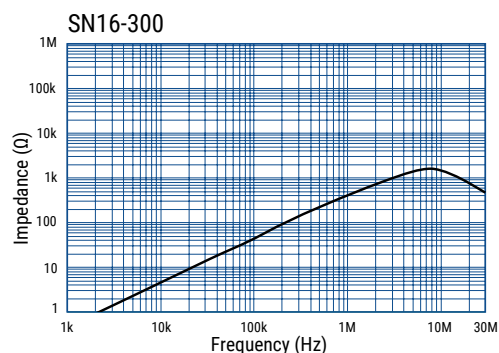
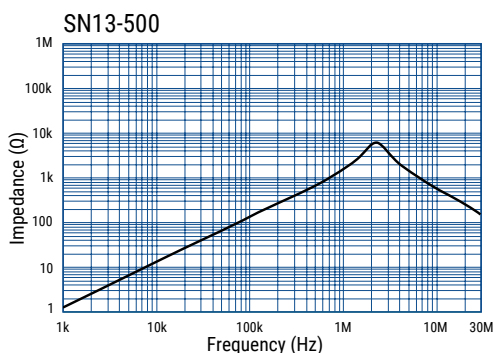
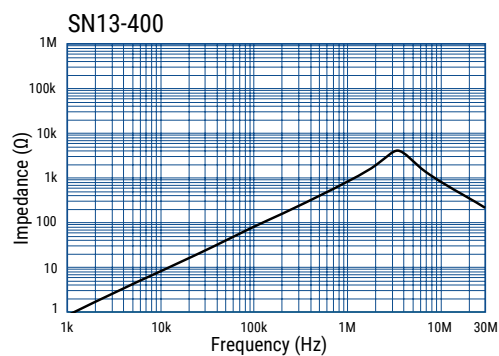
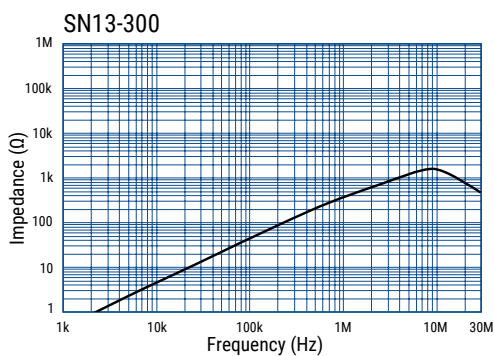
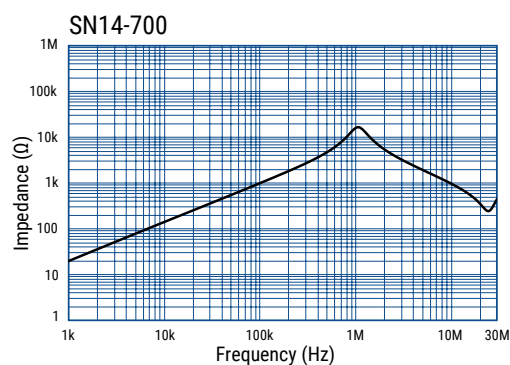
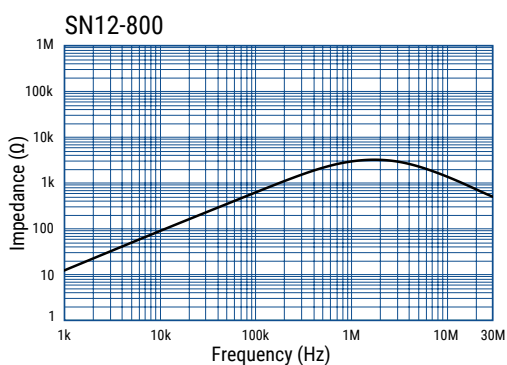
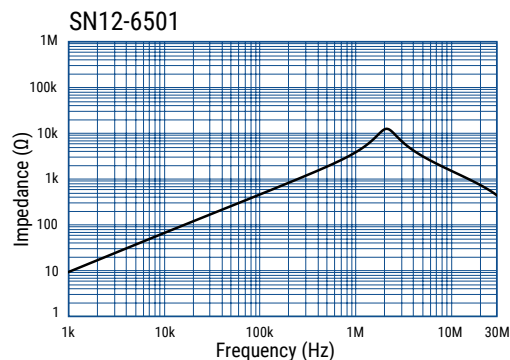
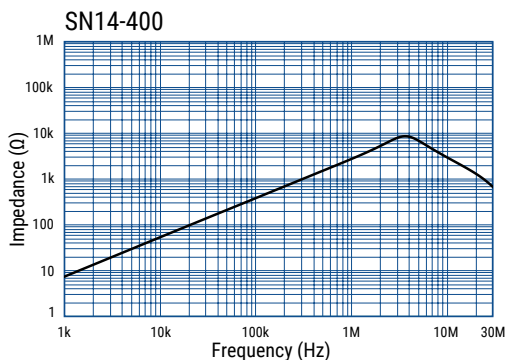

Frequency Characteristics cont.

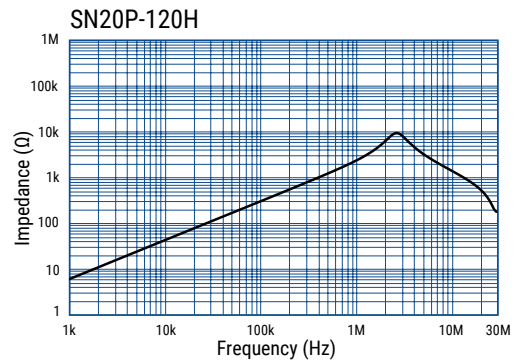
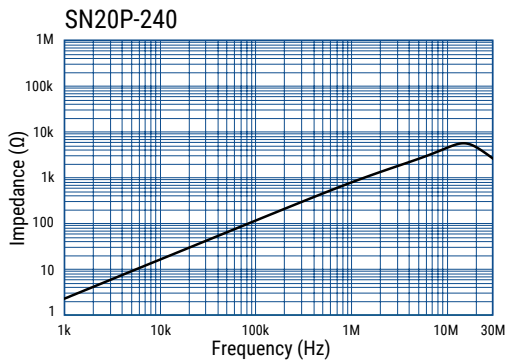
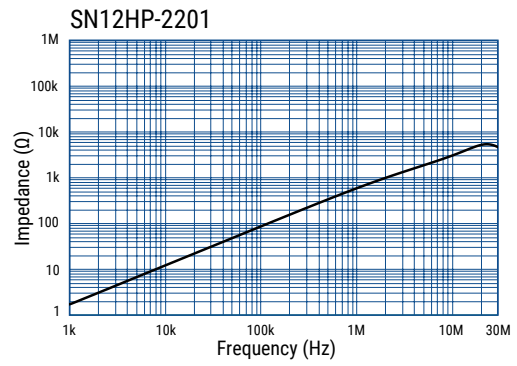
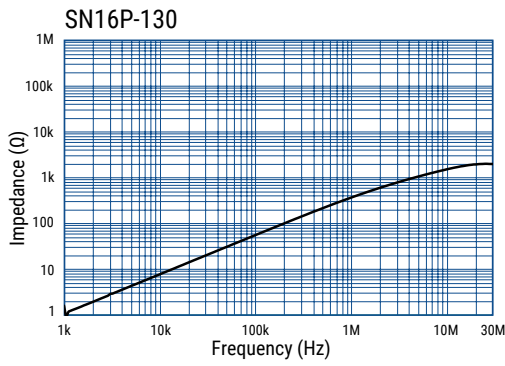
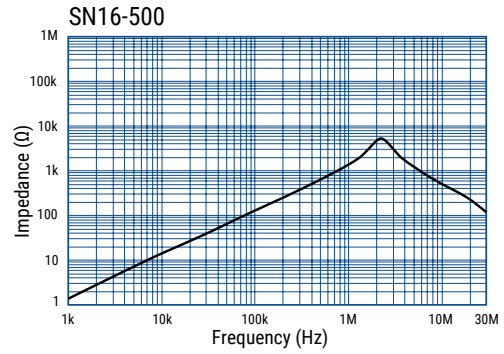
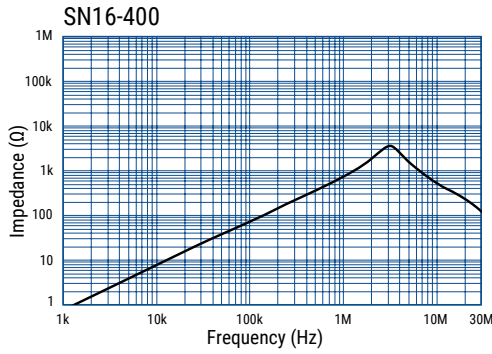

Packaging

Type	Packaging Type	Pieces Per Box
SN3-300	Bulk	6,000
SN5-700		4,800
SN3-200		6,000
SN5-5501		4,800
SN5-1700		
SN5-300		4,800
SN5-400		
SN8S-300		3,000
SN8S-400		
SN8S-500		
SN8D-300		1,800
SN8D-400		
SN8D-500		
SN10P-800		Tray
SN3-100	Bulk	6,000
SN10-300		1,000
SN10-400		
SN10-500		
SN14P-770H	Tray	150
SN8S-130		3,000
SN12-300		350
SN12-400		
SN12-500		
SN12P-500		250
SN14-400		
SN12-6501		350
SN12-800		
SN14-700		250
SN13-300		
SN13-400		
SN13-500		
SN16-300		
SN16-400		
SN16-500		
SN16P-130		350
SN12HP-2201		
SN20P-240		
SN20P-120H		40

Handling Precautions

Precautions for product storage

AC Line Filters should be stored in normal working environments. While the chokes themselves are quite robust in other environments, solderability will be degraded by exposure to high temperatures, high humidity, corrosive atmospheres, and long term storage.

KEMET recommends that maximum storage temperature not exceed 40°C and maximum storage humidity not exceed 70% relative humidity. Atmospheres should be free of chlorine and sulfur bearing compounds. Temperature fluctuations should be minimized to avoid condensation on the parts. Avoid storage near strong magnetic fields, as this might magnetize the product.

For optimized solderability, AC line filters stock should be used promptly and preferably within 6 months of receipt.

Product temperature rise values

The values listed for temperature rise are the result of self-heating in wires when the rated current (commercial frequency) is applied.

When using the product, check and evaluate the value of the core temperature rise under actual operating conditions.

KEMET Electronics Corporation Sales Offices

For a complete list of our global sales offices, please visit www.kemet.com/sales.

Disclaimer

All product specifications, statements, information and data (collectively, the "Information") in this datasheet are subject to change. The customer is responsible for checking and verifying the extent to which the Information contained in this publication is applicable to an order at the time the order is placed. All Information given herein is believed to be accurate and reliable, but it is presented without guarantee, warranty, or responsibility of any kind, expressed or implied.

Statements of suitability for certain applications are based on KEMET Electronics Corporation's ("KEMET") knowledge of typical operating conditions for such applications, but are not intended to constitute – and KEMET specifically disclaims – any warranty concerning suitability for a specific customer application or use. The Information is intended for use only by customers who have the requisite experience and capability to determine the correct products for their application. Any technical advice inferred from this Information or otherwise provided by KEMET with reference to the use of KEMET's products is given gratis, and KEMET assumes no obligation or liability for the advice given or results obtained.

Although KEMET designs and manufactures its products to the most stringent quality and safety standards, given the current state of the art, isolated component failures may still occur. Accordingly, customer applications which require a high degree of reliability or safety should employ suitable designs or other safeguards (such as installation of protective circuitry or redundancies) in order to ensure that the failure of an electrical component does not result in a risk of personal injury or property damage.

Although all product-related warnings, cautions and notes must be observed, the customer should not assume that all safety measures are indicated or that other measures may not be required.

When providing KEMET products and technologies contained herein to other countries, the customer must abide by the procedures and provisions stipulated in all applicable export laws and regulations, including without limitation the International Traffic in Arms Regulations (ITAR), the US Export Administration Regulations (EAR) and the Japan Foreign Exchange and Foreign Trade Act.

KEMET is a registered trademark of KEMET Electronics Corporation.

单击下面可查看定价，库存，交付和生命周期等信息

[>>KEMET\(基美\)](#)