

TSP, Tantalum, Polymer Tantalum, HRA, 44 uF, 20%, 50 VDC, 2X

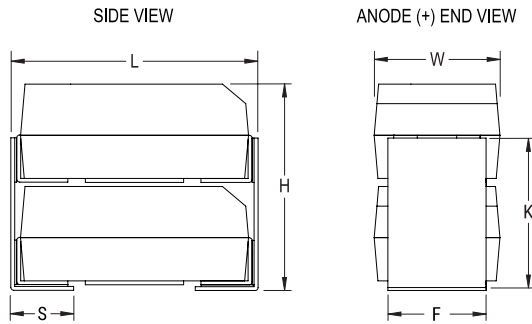

General Information	
Series:	TSP
Dielectric:	Polymer Tantalum
Style:	Stacked Chip
Description:	SMD, Polymer, KO, Stacks, High Reliability
Features:	High Reliability
RoHS:	Yes
Termination:	Tin
Termination (Stack):	Tin
AEC-Q200:	No
MSL:	3

Dimensions	
Case Code	2X
L	8mm +/-0.38mm
W	4.4mm +/-0.2mm
H	8.9mm +/-0.38mm
S	1.9mm +/-0.38mm
F	3mm +/-0.2mm
K	6.9mm +/-0.38mm

Specifications	
Capacitance:	44 uF
Capacitance Tolerance:	20%
Voltage DC:	50 VDC (105C), 33.5 VDC (125C)
Temperature Range:	-55/+125°C
Rated Temperature:	105°C
Dissipation Factor:	10% 120Hz 25C
Failure Rate:	N/A
Resistance:	40 mOhms (100kHz 25C)
Leakage Current:	220 uA (5min 25°C)
Testing and Reliability:	4 Cycles At +25C +/-5C Before Voltage Aging

Packaging Specifications	
Packaging:	Tray
Packaging Quantity:	50

单击下面可查看定价，库存，交付和生命周期等信息

[>>KEMET\(基美\)](#)