

Overview

The hermetically sealed T252 Series solid tantalum capacitors offer high capacitance-to-volume ratios and are offered in standard MIL style A, B, C, and D cases. They meet or exceed the environmental and mechanical requirements of MIL-C-39003. Designed to operate from -55°C to +125°C, The T252 Series exhibits exceptionally low DC leakage, dissipation factor and impedance

characteristics. They are ideal for coupling, bypass, filtering and timing circuits, and are excellent substitutes for wet tantalum's in low voltage applications. These parts are available in style CSR33 (T252 Series) per MIL-PRF-39003/06 in capacitance value of 1.2 μ F to 1000 μ F and working voltages pF 6 VDC to 50 VDC.

Benefits

- Taped and reeled per EIA Specification RS-296
- Marking per MIL-STD-1285
- Qualified to MIL-PRF-39003 (CSR33 Style)
- Failure rate options: Graded – B, C, D and G Exponential - M, P, R, and S*
- Capacitance values of 1.2 μ F to 1000 μ F
- Tolerances of $\pm 10\%$ and $\pm 20\%$
- Voltage rating of 6 – 50 VDC
- Operating temperature range of -55°C to +125°C
- Case sizes: A, B, C, D

*Failure rates apply to military products only



Applications

These capacitors are ideal for coupling, bypass, filtering and timing circuits, and are excellent substitutes for wet tantalum's in low voltage applications.

Ordering Information

T	252	A	125	K	050	M	S	C
Capacitor Class	Series	Case Size	Capacitance Code (pF)	Capacitance Tolerance	Rated Voltage (VDC)	Failure Rate/Military Product Only	Termination Finish	Specification
T = Tantalum	252 (CSR33)	A B C D	First two digits represent significant figures. Third digit specifies number of zeros.	K = ±10% M = ±20%	006 = 6 010 = 10 015 = 15 020 = 20 035 = 35 050 = 50	Graded: B = 0.1%/k hours C = 0.01%/k hours D = 0.001%/k hours Exponential: M = 1%/k hours P = 0.1%/k hours R = 0.01%/k hours S = 0.001%/k hours	S = Standard	All capacitors are sleeved unless specified. 0100 = Without sleeve 7200 = Tape & Reel 7293 & 7443 = Ammo 4250 = 10 cycles, 25°C after Weibull 4251 = 10 cycles, -55°C and 85°C after Weibull 4252 = 10 cycles, -55°C and 85°C before Weibull

Ordering Information – T252 (CSR33 Style)

MIL product

M39003	/06	4073	B
Capacitor Class	Slash	Dash Number	Surge Option
Military specification number	Specification sheet number	Failure rate level	B = C-4251 C = C-4252

Orders should be entered by the military specification number, including the dash number and surge option letter (B or C).

Performance Characteristics

Item	Performance Characteristics
Operating Temperature	-55°C to 125°C
Rated Capacitance Range	1.2 – 1,000 µF at 120 Hz/25°C
Capacitance Tolerance	K Tolerance (10%), M Tolerance (20%)
Rated Voltage Range	6 – 50 V
DF (120 Hz at 25°C)	Refer to Part Number Electrical Specification Table
ESR and Impedance (100 kHz at 25°C)	Refer to Part Number Electrical Specification Table (for reference only)
Leakage Current	Refer to Part Number Electrical Specification Table (at rated voltage up to +85°C and 2/3 of rated voltage applied at 125°C)
Failure Rate (MIL-39003, CSR13 capacitors only)	Approved failure rate: S (0.001%/k hours) – Exponential, D (0.001%/k hours) – Graded

Dimensions – Inches (Millimeters)

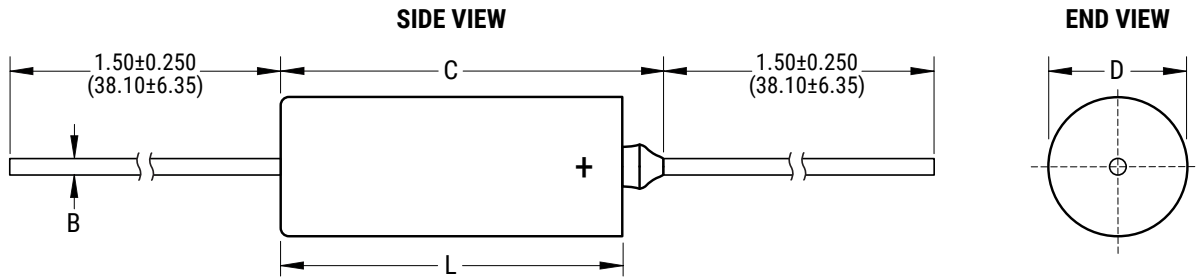

Case Size	Uninsulated		Insulated		B ±0.002 ±(0.05)	C Maximum
	D ±0.005 ±(0.13)	L ±0.031 ±(0.79)	D ±0.010 ±(0.25)	L ±0.031 ±(0.79)		
A	0.125 (3.18)	0.250 (6.35)	0.135 (3.43)	0.286 (7.26)	0.020 (0.51)	0.422 (10.72)
B	0.175 (4.45)	0.438 (11.13)	0.185 (4.70)	0.474 (12.04)	0.020 (0.51)	0.610 (15.49)
C	0.279 (7.09)	0.650 (16.51)	0.289 (7.34)	0.686 (17.42)	0.025 (0.64)	0.822 (20.88)
D	0.341 (8.66)	0.750 (19.05)	0.351 (8.92)	0.786 (19.96)	0.025 (0.64)	0.922 (23.42)

Table 1 – Ratings & Part Number Reference

Rated Voltage	Rated Capacitance	Case Size Code	DC Leakage	DF % at 25°C	MIL-PRF-39003 (CSR33) Capacitors										KEMET Equivalent Military
					Dash Number Reference										
					Failure Rate Level (%/1,000 Hours)										
					MIL-PRF-39003/6F					MIL-PRF-39003/6F					
					Exponential					Graded					
(V) 85°C	µF		µA at 25°C Max/5 Minutes	120 Hz Maximum	M (1.0)	P (0.1)	R (0.01)	S (0.001)	G (1)	B (0.1)	C (0.01)	D (0.001)	Part Number		
6	10.0	A	0.5	6	0001	0101	0201	0301	5001	2001	3001	4001	T252A106K006(1)S		
6	10.0	A	0.5	6	0002	0102	0202	0302	5002	2002	3002	4002	T252A106M006(1)S		
6	12.0	A	0.5	6	0003	0103	0203	0303	5003	2003	3003	4003	T252A126K006(1)S		
6	100.0	B	1.0	8	0004	0104	0204	0304	5004	2004	3004	4004	T252B107K006(1)S		
6	100.0	B	1.0	8	0005	0105	0205	0305	5005	2005	3005	4005	T252B107M006(1)S		
6	330.0	C	2.0	8	0006	0106	0206	0306	5006	2006	3006	4006	T252C337K006(1)S		
6	330.0	C	2.0	8	0007	0107	0207	0307	5007	2007	3007	4007	T252C337M006(1)S		
6	390.0	C	2.0	10	0008	0108	0208	0308	5008	2008	3008	4008	T252C397K006(1)S		
6	470.0	C	2.0	10	0009	0109	0209	0309	5009	2009	3009	4009	T252C477K006(1)S		
6	470.0	C	2.0	10	0010	0110	0210	0310	5010	2010	3010	4010	T252C477M006(1)S		
6	680.0	D	5.0	10	0011	0111	0211	0311	5011	2011	3011	4011	T252D687K006(1)S		
6	680.0	D	5.0	10	0012	0112	0212	0312	5012	2012	3012	4012	T252D687M006(1)S		
6	820.0	D	5.0	10	0013	0113	0213	0313	5013	2013	3013	4013	T252D827K006(1)S		
6	1000.0	D	5.0	10	0014	0114	0214	0314	5014	2014	3014	4014	T252D108K006(1)S		
6	1000.0	D	5.0	10	0015	0115	0215	0315	5015	2015	3015	4015	T252D108M006(1)S		
10	6.8	A	0.5	6	0016	0116	0216	0316	5016	2016	3016	4016	T252A685K010(1)S		
10	6.8	A	0.5	6	0017	0117	0217	0317	5017	2017	3017	4017	T252A685M010(1)S		
10	8.2	A	0.5	6	0018	0118	0218	0318	5018	2018	3018	4018	T252A825K010(1)S		
10	47.0	B	1.0	6	0019	0119	0219	0319	5019	2019	3019	4019	T252B476K010(1)S		
10	47.0	B	1.0	6	0020	0120	0220	0320	5020	2020	3020	4020	T252B476M010(1)S		
10	56.0	B	1.0	6	0021	0121	0221	0321	5021	2021	3021	4021	T252B566K010(1)S		
10	68.0	B	1.0	6	0022	0122	0222	0322	5022	2022	3022	4022	T252B686K010(1)S		
10	68.0	B	1.0	6	0023	0123	0223	0323	5023	2023	3023	4023	T252B686M010(1)S		
10	82.0	B	1.0	6	0024	0124	0224	0324	5024	2024	3024	4024	T252B826K010(1)S		
10	220.0	C	1.0	8	0025	0125	0225	0325	5025	2025	3025	4025	T252C227K010(1)S		
10	220.0	C	1.0	8	0026	0126	0226	0326	5026	2026	3026	4026	T252C227M010(1)S		
10	270.0	C	2.0	8	0027	0127	0227	0327	5027	2027	3027	4027	T252C277K010(1)S		
10	390.0	D	2.0	10	0028	0128	0228	0328	5028	2028	3028	4028	T252D397K010(1)S		
10	470.0	D	4.0	10	0029	0129	0229	0329	5029	2029	3029	4029	T252D477K010(1)S		
10	470.0	D	4.0	10	0030	0130	0230	0330	5030	2030	3030	4030	T252D477M010(1)S		
10	560.0	D	4.0	10	0031	0131	0231	0331	5031	2031	3031	4031	T252D567K010(1)S		
15	4.7	A	0.5	4	0032	0132	0232	0332	5032	2032	3032	4032	T252A475K015(1)S		
15	4.7	A	0.5	4	0033	0133	0233	0333	5033	2033	3033	4033	T252A475M015(1)S		
15	5.6	A	0.5	4	0034	0134	0234	0334	5034	2034	3034	4034	T252A565K015(1)S		
15	33.0	B	1.0	6	0035	0135	0235	0335	5035	2035	3035	4035	T252B336K015(1)S		
15	33.0	B	1.0	6	0036	0136	0236	0336	5036	2036	3036	4036	T252B336M015(1)S		
15	39.0	B	1.0	6	0037	0137	0237	0337	5037	2037	3037	4037	T252B396K015(1)S		
15	150.0	C	1.0	8	0038	0138	0238	0338	5038	2038	3038	4038	T252C157K015(1)S		
15	150.0	C	1.0	8	0039	0139	0239	0339	5039	2039	3039	4039	T252C157M015(1)S		
15	180.0	C	2.0	8	0040	0140	0240	0340	5040	2040	3040	4040	T252C187K015(1)S		
15	220.0	D	2.0	8	0041	0141	0241	0341	5041	2041	3041	4041	T252D227K015(1)S		
15	220.0	D	2.0	8	0042	0142	0242	0342	5042	2042	3042	4042	T252D227M015(1)S		
15	270.0	D	2.0	8	0043	0143	0243	0343	5043	2043	3043	4043	T252D277K015(1)S		
15	330.0	D	2.0	8	0044	0144	0244	0344	5044	2044	3044	4044	T252D337K015(1)S		
15	330.0	D	2.0	8	0045	0145	0245	0345	5045	2045	3045	4045	T252D337M015(1)S		
20	2.7	A	0.5	4	0046	0146	0246	0346	5046	2046	3046	4046	T252A275K020(1)S		
20	3.3	A	0.5	4	0047	0147	0247	0347	5047	2047	3047	4047	T252A335K020(1)S		
(V) 85°C	µF	Case Size Code	µA at 25°C Max/5 Minutes	120 Hz Maximum	M (1.0)	P (0.1)	R (0.01)	S (0.001)	G (1)	B (0.1)	C (0.01)	D (0.001)	Part Number		
Rated Voltage	Rated Capacitance	Case Size Code	DC Leakage	DF % at 25°C	MIL-PRF-39003 (CSR33) Capacitors										

(1) To complete KEMET Part Number (T252), insert Graded failure rate – A for Not Applicable, B for 0.1%/k hours, C for 0.01%/k hours, D for 0.001%/k hours or G for 1%/k hours. Designates Reliability Level.

(2) To complete KEMET Part Number (T252), insert Exponential failure rate – M for 1%/k hours, P for 0.1%/k hours, R for 0.01%/k hours, or S for 0.001%/k hours. Designates reliability level.

Table 1 – Ratings & Part Number Reference cont'd

Rated Voltage	Rated Capacitance	Case Size Code	DC Leakage	DF % at 25°C	MIL-PRF-39003 (CSR33) Capacitors												
					Dash Number Reference												KEMET Equivalent Military
					Failure Rate Level (%/1,000 Hours)												
					MIL-PRF-39003/6F						MIL-PRF-39003/6F						
					Exponential						Graded						
(V) 85°C	µF		µA at 25°C Max/5 Minutes	120 Hz Maximum	M (1.0)	P (0.1)	R (0.01)	S (0.001)	G (1)	B (0.1)	C (0.01)	D (0.001)	Part Number				
20	3.3	A	0.5	4	0048	0148	0248	0348	5048	2048	3048	4048	T252A335M020(1)S				
20	3.9	A	0.5	4	0049	0149	0249	0349	5049	2049	3049	4049	T252A395K020(1)S				
20	18.0	B	1.0	6	0050	0150	0250	0350	5050	2050	3050	4050	T252B186K020(1)S				
20	22.0	B	1.0	6	0051	0151	0251	0351	5051	2051	3051	4051	T252B226K020(1)S				
20	22.0	B	1.0	6	0052	0152	0252	0352	5052	2052	3052	4052	T252B226M020(1)S				
20	27.0	B	1.0	6	0053	0153	0253	0353	5053	2053	3053	4053	T252B276K020(1)S				
20	56.0	C	1.0	6	0054	0154	0254	0354	5054	2054	3054	4054	T252C566K020(1)S				
20	68.0	C	1.0	6	0055	0155	0255	0355	5055	2055	3055	4055	T252C686K020(1)S				
20	68.0	C	1.0	6	0056	0156	0256	0356	5056	2056	3056	4056	T252C686M020(1)S				
20	82.0	C	1.0	6	0057	0157	0257	0357	5057	2057	3057	4057	T252C826K020(1)S				
20	100.0	C	1.0	6	0058	0158	0258	0358	5058	2058	3058	4058	T252C107K020(1)S				
20	100.0	C	1.0	6	0059	0159	0259	0359	5059	2059	3059	4059	T252C107M020(1)S				
20	120.0	C	1.0	6	0060	0160	0260	0360	5060	2060	3060	4060	T252C127K020(1)S				
20	150.0	D	2.0	8	0061	0161	0261	0361	5061	2061	3061	4061	T252D157K020(1)S				
20	150.0	D	2.0	8	0062	0162	0262	0362	5062	2062	3062	4062	T252D157M020(1)S				
20	180.0	D	2.0	8	0063	0163	0263	0363	5063	2063	3063	4063	T252D187K020(1)S				
35	1.8	A	0.5	4	0064	0164	0264	0364	5064	2064	3064	4064	T252A185K035(1)S				
35	8.2	B	1.0	6	0065	0165	0265	0365	5065	2065	3065	4065	T252B825K035(1)S				
35	10.0	B	1.0	6	0066	0166	0266	0366	5066	2066	3066	4066	T252B106K035(1)S				
35	10.0	B	1.0	6	0067	0167	0267	0367	5067	2067	3067	4067	T252B106M035(1)S				
35	33.0	C	1.0	6	0068	0168	0268	0368	5068	2068	3068	4068	T252C336K035(1)S				
35	33.0	C	1.0	6	0069	0169	0269	0369	5069	2069	3069	4069	T252C336M035(1)S				
35	39.0	C	1.0	6	0070	0170	0270	0370	5070	2070	3070	4070	T252C396K035(1)S				
35	47.0	C	1.0	6	0071	0171	0271	0371	5071	2071	3071	4071	T252C476K035(1)S				
35	47.0	C	1.0	6	0072	0172	0272	0372	5072	2072	3072	4072	T252C476M035(1)S				
35	56.0	D	2.0	6	0073	0173	0273	0373	5073	2073	3073	4073	T252D566K035(1)S				
35	68.0	D	2.0	6	0074	0174	0274	0374	5074	2074	3074	4074	T252D686K035(1)S				
35	68.0	D	2.0	6	0075	0175	0275	0375	5075	2075	3075	4075	T252D686M035(1)S				
50	1.2	A	0.5	4	0076	0176	0276	0376	5076	2076	3076	4076	T252A125K050(1)S				
50	1.5	A	0.5	4	0077	0177	0277	0377	5077	2077	3077	4077	T252A155K050(1)S				
50	1.5	A	0.5	4	0078	0178	0278	0378	5078	2078	3078	4078	T252A155M050(1)S				
50	5.6	B	1.0	4	0079	0179	0279	0379	5079	2079	3079	4079	T252B565K050(1)S				
50	6.8	B	1.0	6	0080	0180	0280	0380	5080	2080	3080	4080	T252B685K050(1)S				
50	6.8	B	1.0	6	0081	0181	0281	0381	5081	2081	3081	4081	T252B685M050(1)S				
50	22.0	C	1.0	6	0082	0182	0282	0382	5082	2082	3082	4082	T252C226K050(1)S				
50	22.0	C	1.0	6	0083	0183	0283	0383	5083	2083	3083	4083	T252C226M050(1)S				
50	27.0	C	1.0	6	0084	0184	0284	0384	5084	2084	3084	4084	T252C276K050(1)S				
50	33.0	D	1.0	6	0085	0185	0285	0385	5085	2085	*	*	T252D336K050(1)S				
50	33.0	D	1.0	6	0086	0186	0286	0386	5086	2086	*	*	T252D336M050(1)S				
50	39.0	D	1.0	6	0087	0187	0287	0387	5087	2087	*	*	T252D396K050(1)S				
(V) 85°C	µF	Case Size Code	µA at 25°C Max/5 Minutes	120 Hz Maximum	M (1.0)	P (0.1)	R (0.01)	S (0.001)	G (1)	B (0.1)	C (0.01)	D (0.001)	Part Number				
Rated Voltage	Rated Capacitance	Case Size Code	DC Leakage	DF % at 25°C	MIL-PRF-39003 (CSR33) Capacitors												

(1) To complete KEMET Part Number (T252), insert Graded failure rate – A for Not Applicable, B for 0.1%/k hours, C for 0.01%/k hours, D for 0.001%/k hours or G for 1%/k hours. Designates Reliability Level.
(2) To complete KEMET Part Number (T252), insert Exponential failure rate – M for 1%/k hours, P for 0.1%/k hours, R for 0.01%/k hours, or S for 0.001%/k hours. Designates reliability level.

Ripple Current/Ripple Voltage

Permissible AC ripple voltage is related to the ESR of the capacitor and the power dissipation capabilities of a particular case size.

Thermal capacities for the various case sizes have been determined empirically and are listed below.

Temperature Compensation Multipliers for Maximum Power Dissipation		
T ≤ 25°C	T ≤ 85°C	T ≤ 125°C
1.00	0.90	0.40

T = Environmental Temperature

Permissible AC ripple current can be determined by the following:

$$I(max) = Z \sqrt{P_{max}/R}$$

P max = maximum watts

R = ESR at specified frequency (ohms)

I = rms ripple current (amperes)

Z = capacitor impedance in ohms at the specified frequency

Case Size	Maximum Power Dissipation (P max)	T2XX
A	0.09	0.070
B	0.100	0.090
C	0.125	–
D	0.180	–

Maximum Power Dissipation: 25°C Ambient

Optimum Solder Wave Profile

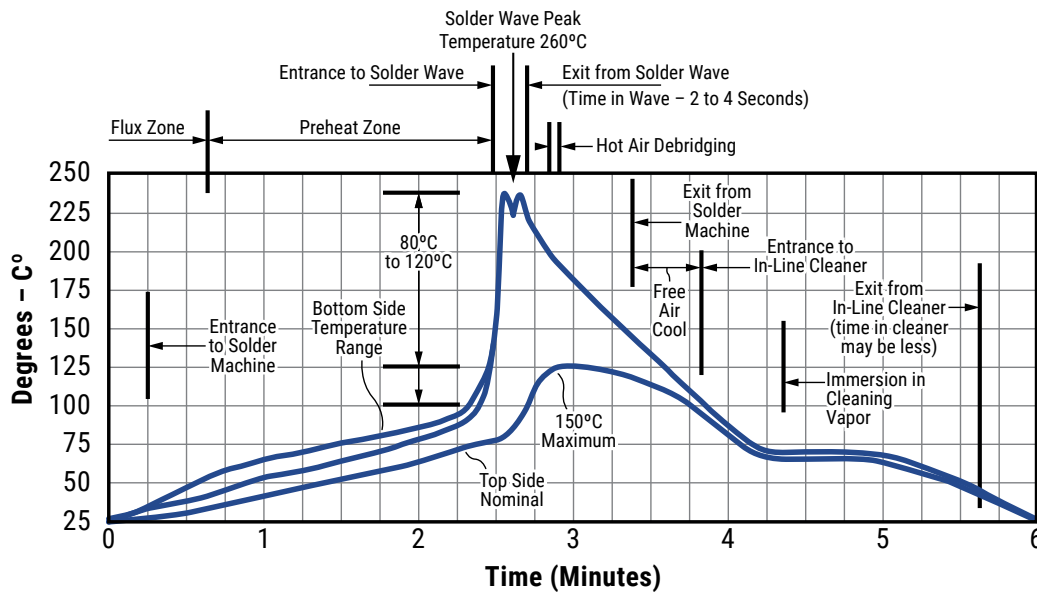

Reverse Voltage

Although these are polar capacitors, some degree of transient voltage reversal is permissible, as seen below. The capacitors should not be operated continuously in reverse mode, even within these limits.

Temperature	Percentage of Rated Voltage
+25°C	15
+85°C	5
+125°C	1

Mounting

All encased capacitors will pass the Resistance to Soldering Heat Test of MIL-STD-202, Method 210, Condition C. This test simulates wave solder of topside board mount product. This demonstration of resistance to solder heat is in accordance with what is believed to be the industry standard. More severe treatment must be considered reflective of an improper soldering process. The above figure is a recommended solder wave profile for both axial and radial leaded solid tantalum capacitors.

Construction

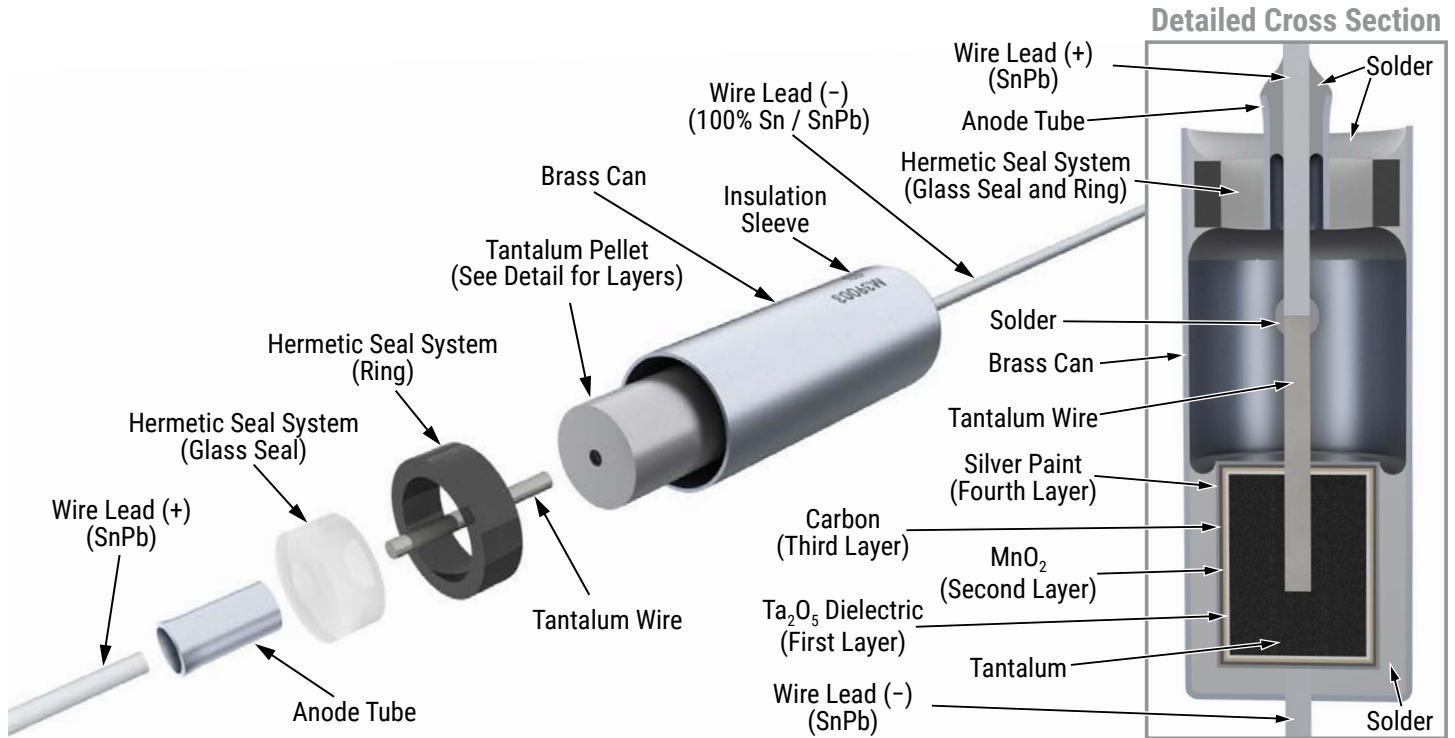

Capacitor Marking

A Case

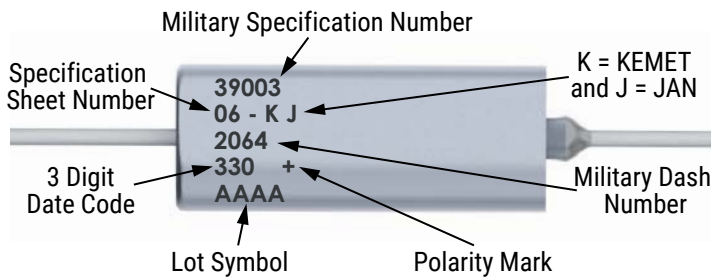

B Case

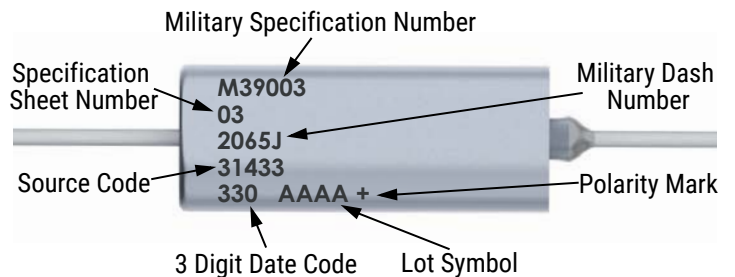

Date Code	3 Digit	4 Digit
Year	5 = 2015	15 = 2015
	6 = 2016	16 = 2016
	7 = 2017	17 = 2017
	8 = 2018	18 = 2018
	9 = 2019	19 = 2019
Week	01 = 1 st week of the year to 52 = 52 nd week of the year	

C and D Case

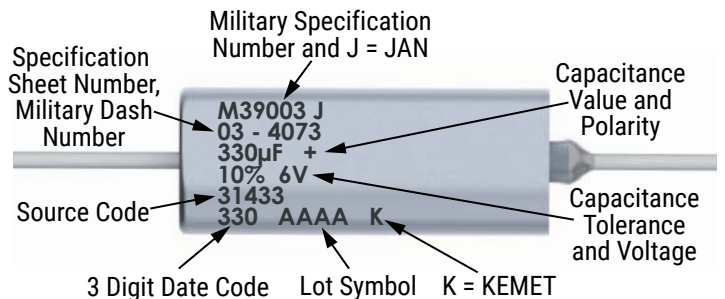

Storage

Tantalum hermetically sealed capacitors should be stored in normal working environments. While the capacitors themselves are quite robust in other environments, solderability will be degraded by exposure to high temperatures, high humidity, corrosive atmospheres, and long term storage. In addition, packaging materials will be degraded by high temperature – reels may soften or warp and tape peel force may increase. KEMET recommends that maximum storage temperature not exceed 40°C and maximum storage humidity not exceed 60% relative humidity. Temperature fluctuations should be minimized to avoid condensation on the parts and atmospheres should be free of chlorine and sulphur bearing compounds. For optimized solderability capacitors stock should be used promptly, preferably within three years of receipt.

Tape & Reel Packaging Information

KEMET offers standard reeling of Solid Tantalum Capacitors for automatic insertion or lead forming machines per EIA Specification RS-296E.

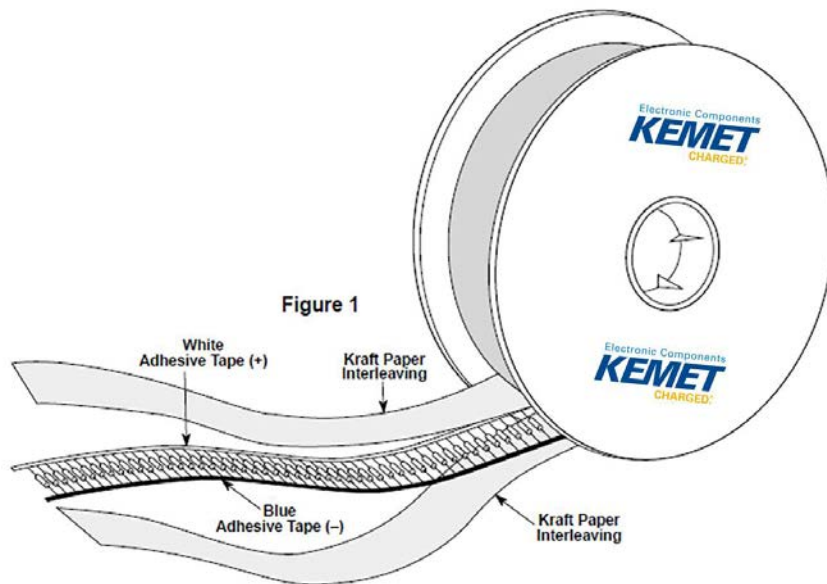

Table 2 – Packaging Quantity

Case Size	Standard Bulk Quantity	Standard Reel Quantity	Reel C-Spec	Ammo Pack Quantity	Ammo Pack C-Spec
A	150/Box	3,500	C-7200	1,500	C-7293
B	75/Box	2,500	C-7200	1,000	Class I
C	20/Tray	500	C-7200	250	C-7442
D	20/Tray	400	C-7200	250	Class II C-7443 Class III

Figure 2

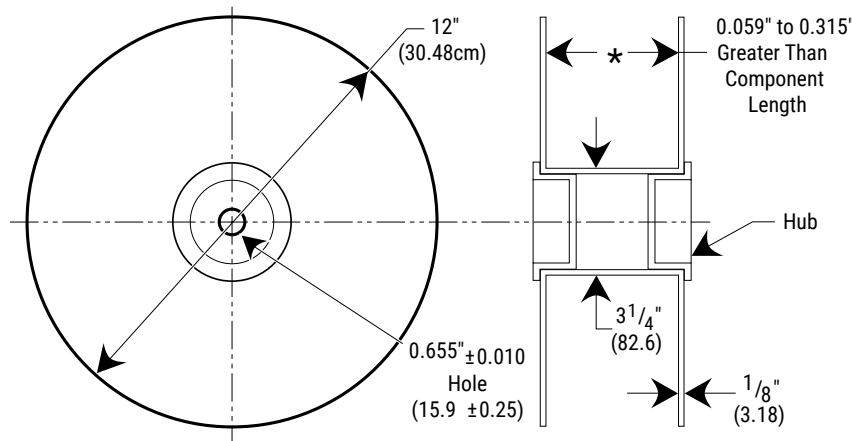

Figure 3

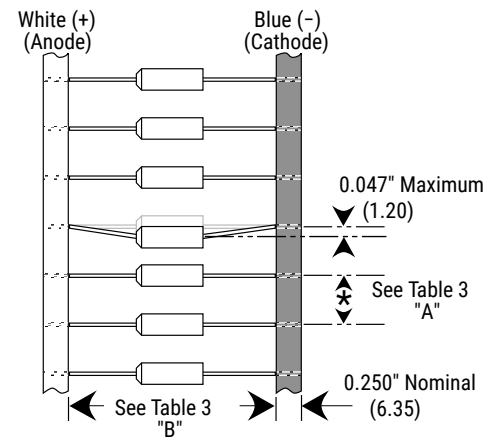

Table 3 – Tape Dimensions

Component Body Diameter	Component Pitch "A"	Inside Tape Spacing "B" ±1.5 mm (0.059")		
		I	II	III
0" (0 mm) to 0.197" (5 mm)	0.020" or (±0.5 mm)	2.062"	2.500"	2.874"
0.197" (5.01 mm) to 0.394" (10 mm)	0.200" or (5 mm)	(52.4 mm)	(63.5 mm)	(73 mm)

Capacitors are reeled so that positive leads are oriented as shown in Figure 3. Kraft paper (50lb. test minimum) is inserted between the layers of capacitors wound on reels for component pitch ≤ 0.200 " sizes and corrugated paper (70 lb. test minimum), single faced is inserted for component pitch ≥ 0.400 " sizes. Capacitor lead length may extend only a maximum of 0.031" (0.8 mm) beyond the tape's edges. Capacitors are centered in a row between the two tapes and will deviate only ± 0.031 " (0.79 mm) from the row center. Figures 1 and 2 show the KEMET standard chipboard tape reel. A minimum of 36" (91.5 cm) leader tape is provided at each end of the reeled capacitors. Universal splicing clips are used to connect the tape.

KEMET Electronics Corporation Sales Offices

For a complete list of our global sales offices, please visit www.kemet.com/sales.

Disclaimer

All product specifications, statements, information and data (collectively, the "Information") in this datasheet are subject to change. The customer is responsible for checking and verifying the extent to which the Information contained in this publication is applicable to an order at the time the order is placed. All Information given herein is believed to be accurate and reliable, but it is presented without guarantee, warranty, or responsibility of any kind, expressed or implied.

Statements of suitability for certain applications are based on KEMET Electronics Corporation's ("KEMET") knowledge of typical operating conditions for such applications, but are not intended to constitute – and KEMET specifically disclaims – any warranty concerning suitability for a specific customer application or use. The Information is intended for use only by customers who have the requisite experience and capability to determine the correct products for their application. Any technical advice inferred from this Information or otherwise provided by KEMET with reference to the use of KEMET's products is given gratis, and KEMET assumes no obligation or liability for the advice given or results obtained.

Although KEMET designs and manufactures its products to the most stringent quality and safety standards, given the current state of the art, isolated component failures may still occur. Accordingly, customer applications which require a high degree of reliability or safety should employ suitable designs or other safeguards (such as installation of protective circuitry or redundancies) in order to ensure that the failure of an electrical component does not result in a risk of personal injury or property damage.

Although all product-related warnings, cautions and notes must be observed, the customer should not assume that all safety measures are indicated or that other measures may not be required.

KEMET is a registered trademark of KEMET Electronics Corporation.

单击下面可查看定价，库存，交付和生命周期等信息

[>>KEMET\(基美\)](#)