

版次	变更摘要	日期
1	增加料号说明	2015/1/28

序号	品名	材质
①	0.5掀盖胶芯 (H2.0)	LCP UL94V-0 本色
②	0.5掀盖端子 (H2.0)	磷青铜/表面镀锡
③	0.5掀盖后盖 (H2.0)	LCP UL94V-0 黑色
④	0.5掀盖焊片 (H2.0)	黄铜/表面镀锡

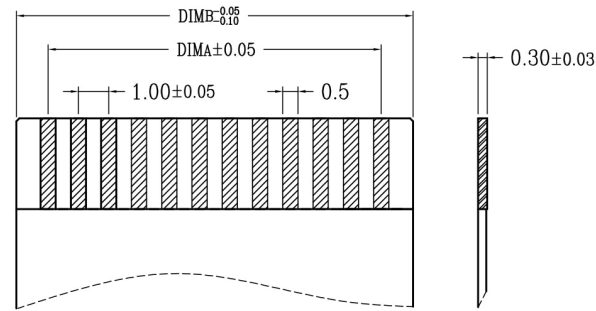
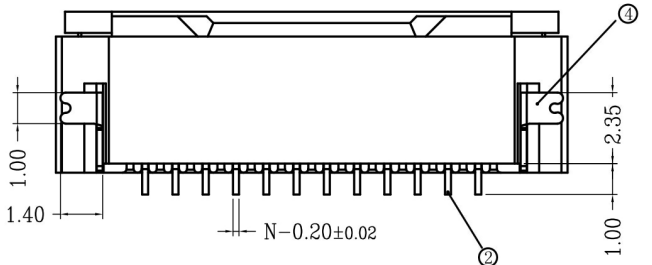
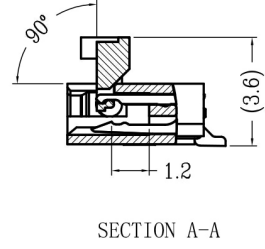
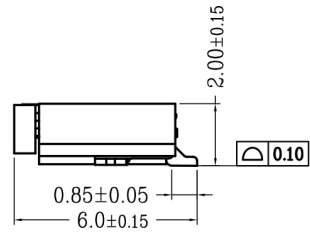
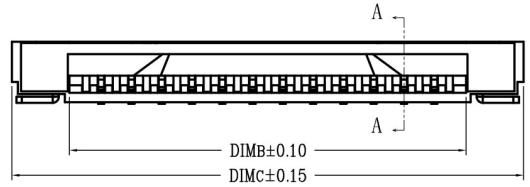
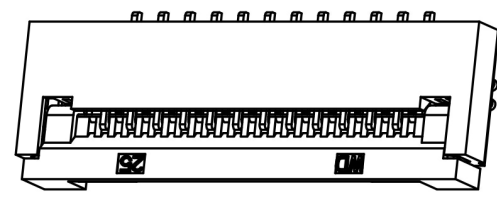
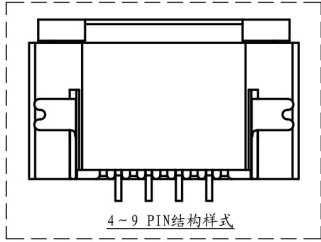
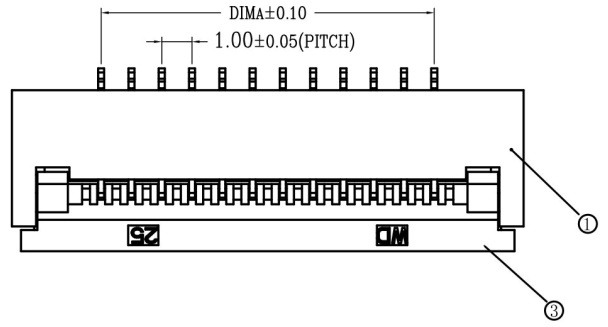

CKT	DIMA	DIMB	DIMC
4	3.00	5.10	8.90
5	4.00	6.10	9.90
6	5.00	7.10	10.90
7	6.00	8.10	11.90
8	7.00	9.10	12.90
9	8.00	10.10	13.90
10	9.00	11.10	14.90
11	10.00	12.10	15.90
12	11.00	13.10	16.90
13	12.00	14.10	17.90
14	13.00	15.10	18.90
15	14.00	16.10	19.90
16	15.00	17.10	20.90
17	16.00	18.10	21.90
18	17.00	19.10	22.90
19	18.00	20.10	23.90
20	19.00	21.10	24.90
21	20.00	22.10	25.90
22	21.00	23.10	26.90
23	22.00	24.10	27.90
24	23.00	25.10	28.90
25	24.00	26.10	29.90
26	25.00	27.10	30.90
27	26.00	28.10	31.90
28	27.00	29.10	32.90
29	28.00	30.10	33.90
30	29.00	31.10	34.90

- 技术指标:
1. 塑件表面应光洁、无毛边、无明显收缩、缺陷、裂纹等现象。
 2. 温度范围: -25° C~85° C.
 3. 额定电压: 50V, AC/DC(等效).
 4. 接触电阻: ≤0.03Ω.
 5. 绝缘电阻: ≥500MΩ
 6. 产品料号:

适用扁平线

适用线路板

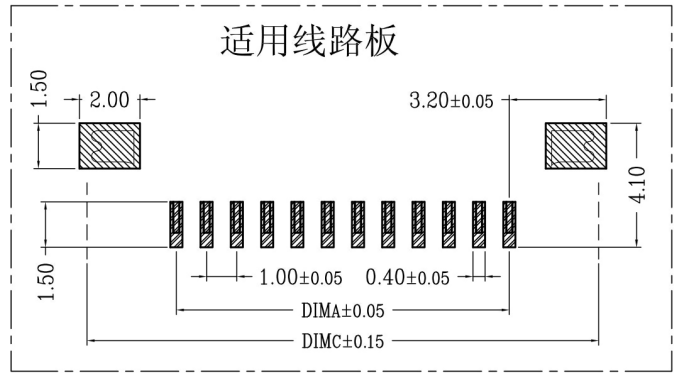

XW10202-***-**-**

NO OF CKT (产品PIN数) 00 后盖有LOGO:WD
0W 后盖无LOGO

Plating (电镀方式) 0 端子全雾锡
1 端子全金 (G/F OVERALL)
5 端子半金锡

Packing (包装方式) T TUBE管装
R TAPE & REEL卷装

一般公差 (TOLERANCE)
X ±.50 **XX** ±.10
Y ±.20 **XXX** ±.05
 ANGLES ±1°

深圳市金航标电子有限公司		WWW. BDS666. COM	
KH-FG1.0-H2.0-28PIN		0755-83044319	
品名 (TITLE)	1.0 Pitch掀盖卧式下接 (H=2.0)	制图 (DR)	Anlan
料号 (DWG.NO)	XW10202-***-**-**	校对 (CHKD)	王涛
比例 (SCALE)	1:1	审核 (APPD)	黄志明
单位 (UNITS)	mm	张数 (SHEET)	1 OF 1
尺寸 (SIZE)	A4	REV	A

单击下面可查看定价，库存，交付和生命周期等信息

[>>kinghelm\(金航标\)](#)