

Kinghelm®

标记 REV. LTR.	日期 DATE	版别 REV.	变更内容 REVISION	签名 SIGN.
-----------------	------------	------------	------------------	-------------

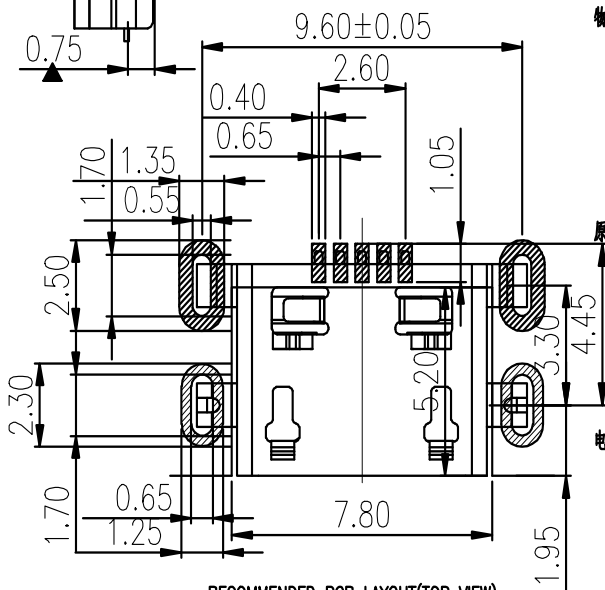
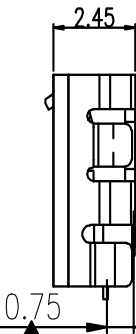
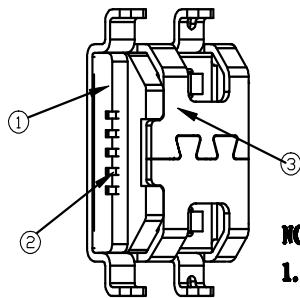
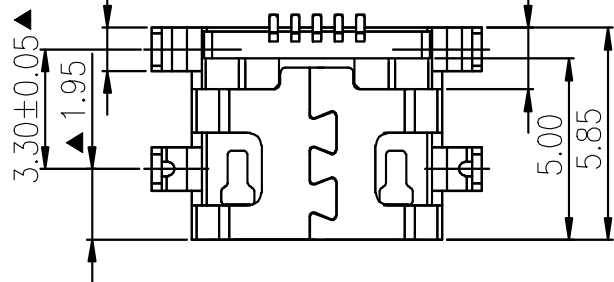
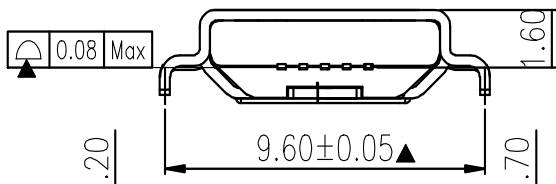
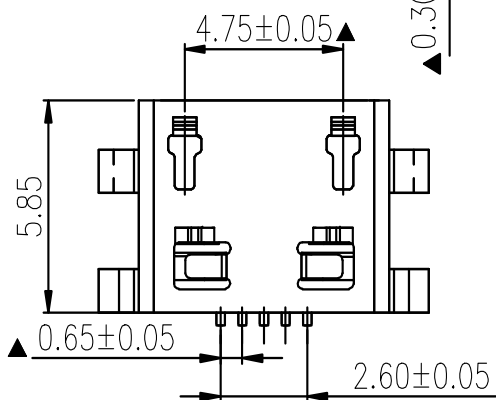
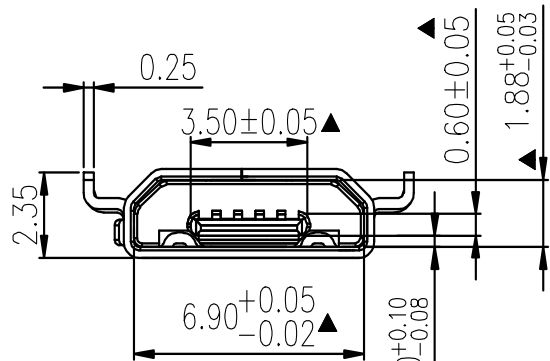

RECOMMENDED PCB LAYOUT(TOP VIEW)
GENERAL TOLERANCES:±0.05

表面处理 PLATING	
料厚 THICKNESS	
材料 MATERIAL	

GENERAL TOLERANCES	I	II	III	品名 TITLE
Q,DL,SS	±0.01	±0.02	±0.03	MICRO USB DP B TYPE
X,XX	±0.03	±0.05	±0.08	规格0.8MM 间距 5P
X,XX	±0.05	±0.10	±0.12	料号 PART NO.
X,X	±0.10	±0.15	±0.20	图号 DRAWING NO.
AL,SL	±0.5°	±1.0°	±2.0°	图名 DRAWING NAME

规格说明 Specifications:

电气特性 Electrical:

NOTES:

1. 成品功能要求不可有端子压伤及塑胶毛边。
2. 标有“▲”记号者为重点检验尺寸。
3. 未标注尺寸公差为按自由公差为准。
4. 成品端子平面度必须100%检测。
5. 接触强度1.0kg/in

1. 额定电流: Current Rating
1.8A/contact terminal

2. 额定电压: Voltage Rating
30V DC

3. 接触电阻 Contact Resistance
50 milliohms MAX

4. 耐电压 Dielectric Withstanding Voltage:
300 V AC AT Sea Level

5. 绝缘电阻 Insulation Resistance:
100MEGA ohms MIN

物理性能 Mechanical:

1. 插拔力: Connector Mate and Unmate Force
Mate force: 3.0kgf(MAX)
Unmate force: 0.7kgf(MIN)

2. 机械寿命: 5000次

原材料 Material:

1. 塑胶 Housing:
Hing Temperature Thermoplastic
UL 94V-0 LCP Black

2. 端子 磷铜 C5191 EH

3. 外壳 Shell: H65 EH

电镀 Finish:

1. 端子 Contact: Plated Gold in Mating Area;
Tin On Solder Tails

2. 外壳 Shell:
Nickel Plating (能过炉自动上锡)

品名 TITLE	MICRO USB DP B TYPE 规格0.8MM 间距 5P	深圳市金航标电子有限公司
料号 PART NO.	XXXXXXXX	WWW.BDS666.COM
图号 DRAWING NO.		KH-MICRO0.8CB-5P
图名 DRAWING NAME		0755-83044319
页次 PAGE	1/1	路径 FILE NAME

单击下面可查看定价，库存，交付和生命周期等信息

[>>kinghelm\(金航标\)](#)