

DRAWING TYPE CUSTOMER DRAWING

MARK	DATE	DESCRIPTION	DESIGN
J	2016.06.18	ADD 41PIN	WANGPENG
K	2017.06.08	Change Plating Note	CHEN
L	2019.01.16	UPDATE P/N	CHEN

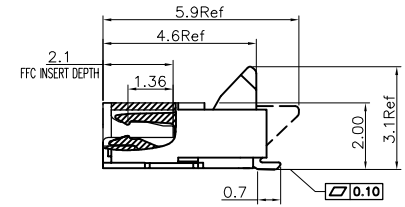
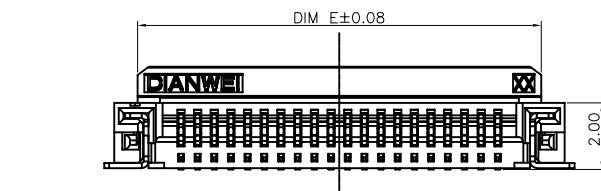
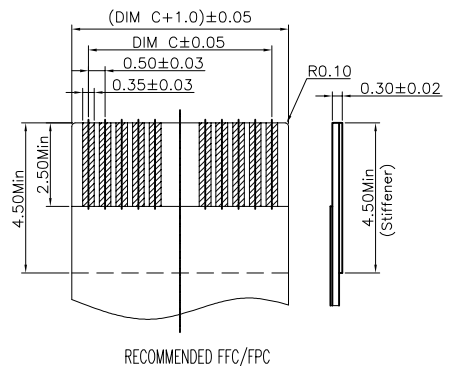
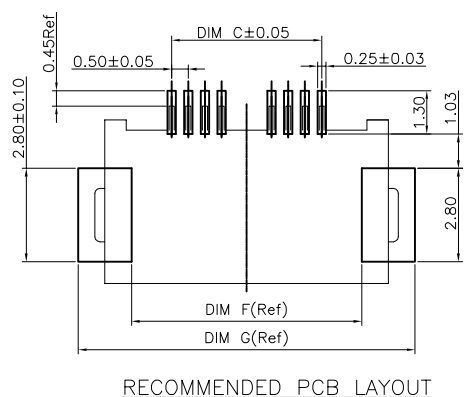
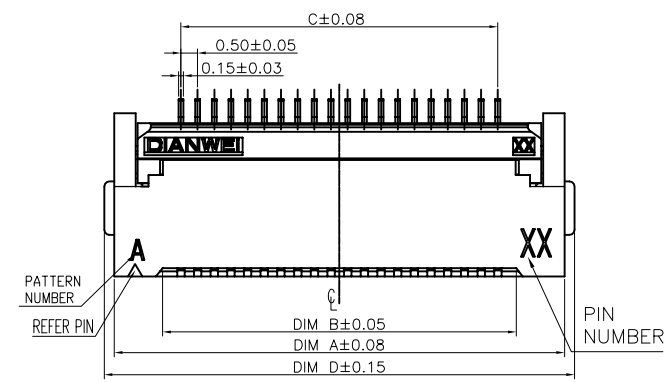

- FPC NOT MATING CONDITION BANNED CLOSURE
  - PART NO. LEGEND:  
**8.01A0.\*\*\*200**  
 ① ② ③ ④ ⑤
  - SERIES NAME: 8.01A0= 0.5MM FFC/FPC DUAL CONTACT SIDE CONNECTOR (H=2.0mm)
  - CONTACT PIN NUMBER: \*\*\*=CONTACT PIN NUMBER
  - CONTACT AREA PLATING SPEC: GOLD PLATING: 2=1~3u"; 3=5u"; 4=10u"; 5=15u"  
 SOLDER AREA PLATING SPEC: GOLD PLATING: 2=1~3u"; 3=5u"; 4=10u"; 5=15u"
  - UNSPECIFIED:0=NONSENSE
  - UNSPECIFIED:0=NONSENSE
3. PERFORMANCE:
- CURRENT RATING: 0.5A/PIN.
  - VOLTAGE RATING: 50V (AC/DC).
  - CONTACT RESISTANCE: INITIAL VALUE 30mOHM Max,
  - INSULATION RESISTANCE: 500MOHM Min.
  - DIELECTRIC WITHSTANDING VOLTAGE: 250V AC FOR 1MINUTE;
  - DURABILITY: 20 TIMES Min.
  - OPERATING TEMPERATURE: -40°C~+85°C  
 OPERATING HUMIDITY RANGE: 20% TO 85%

Pin No	P/N	DIM A	DIM B	DIM C	DIM D	DIM E	DIM F	DIM G
4	8.01A0.004200	5.50	2.55	1.50	6.10	4.10	3.90	7.10
5	8.01A0.006200	6.00	3.05	2.00	6.60	4.60	4.40	7.60
6	8.01A0.008200	6.50	3.55	2.50	7.10	5.10	4.90	8.10
8	8.01A0.009200	7.50	4.55	3.50	8.10	6.10	5.90	9.10
9	8.01A0.010200	8.00	5.05	4.00	8.60	6.60	6.40	9.60
10	8.01A0.012200	8.50	5.55	4.50	9.10	7.10	6.90	10.10
12	8.01A0.012200	9.50	6.55	5.50	10.10	8.10	7.90	11.10
14	8.01A0.014200	10.50	7.55	6.50	11.10	9.10	8.90	12.10
15	8.01A0.015200	11.00	8.05	7.00	11.60	9.60	9.40	12.60
16	8.01A0.016200	11.50	8.55	7.50	12.10	10.10	9.90	13.10
18	8.01A0.018200	12.50	9.55	8.50	13.10	11.10	10.90	14.10
20	8.01A0.020200	13.50	10.55	9.50	14.10	12.10	11.90	15.10
22	8.01A0.022200	14.50	11.55	10.50	15.10	13.10	12.90	16.10
24	8.01A0.024200	15.50	12.55	11.50	16.10	14.10	13.90	17.10
26	8.01A0.026200	16.50	13.55	12.50	17.10	15.10	14.90	18.10
28	8.01A0.028200	17.50	14.55	13.50	18.10	16.10	15.90	19.10
30	8.01A0.030200	18.50	15.55	14.50	19.10	17.10	16.90	20.10
32	8.01A0.032200	19.50	16.55	15.50	20.10	18.10	17.90	21.10
34	8.01A0.034200	20.50	17.55	16.50	21.10	19.10	18.90	22.10
35	8.01A0.035200	21.00	18.05	17.00	21.60	19.60	19.40	22.60
36	8.01A0.036200	21.50	18.55	17.50	22.10	20.10	19.90	23.10
38	8.01A0.038200	22.50	19.55	18.50	23.10	21.10	20.90	24.10
40	8.01A0.040200	23.50	20.55	19.50	24.10	22.10	21.90	25.10
41	8.01A0.041200	24.00	21.05	20.00	24.60	22.60	22.40	25.60
42	8.01A0.042200	24.50	21.55	20.50	25.10	23.10	22.90	26.10
45	8.01A0.045200	26.00	23.05	22.00	26.60	24.60	24.40	27.60
50	8.01A0.050200	28.50	25.55	24.50	29.10	27.10	26.90	30.10
51	8.01A0.051200	29.00	26.05	25.00	29.60	27.60	27.40	30.60
52	8.01A0.052200	29.50	26.55	25.50	30.10	28.10	27.90	31.10
54	8.01A0.054200	30.50	27.55	26.50	31.10	29.10	28.90	32.10
55	8.01A0.055200	31.00	28.05	27.00	31.60	29.60	29.40	32.60
58	8.01A0.058200	32.50	29.55	28.50	33.10	31.10	30.90	34.10
60	8.01A0.060200	33.50	30.55	29.50	34.10	32.10	31.90	35.10

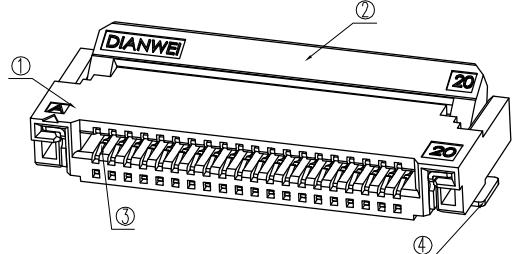
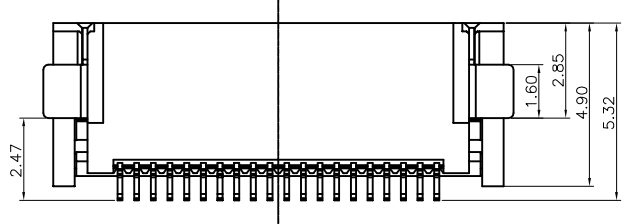

NO.	COMPONENTS	MATERIALS	FINISH/COLOR	SPECIFICATION	QUANTITY
4	STATOR	BRASS			2
3	TERMINAL	PHOSPHOR BRONZE			POSITIONS
2	COVER	THERMOPLASTIC UL94V-0	BLACK		1
1	HOUSING	THERMOPLASTIC UL94V-0	NATURAL		1

深圳市金航标电子有限公司 www.kinghelm.com.cn

KH-FPC0.5-H2.0SMT-60P-QCHF 0755-28190160

UNLESS OTHERWISE SPECIFIED TOLERANCE

ANG	TOL	DIM	TOL
.X	±3.0°	.X	±0.20
.XX	±2.0°	.XX	±0.10
.XXX	±1.0°	.XXX	±0.05

DRAWING NO: 8.01A0-C PART NAME: 0.5mm FFC/FPC DUAL CONTACT SIDE CONNECTOR(H=2.0mm)

APPROVED: CHEN VERIFIED: DESIGN: CHEN PART NO.: 8.01A0.\*\*\*200

DATE	UNITS	SCALE	PAGE	REV
2019.01.16	mm	1:1	1/1	L

NOTE: ALL RIGHTS RESERVED, BANNED COPY!

单击下面可查看定价，库存，交付和生命周期等信息

[>>kinghelm\(金航标\)](#)