

PRODUCT NO.	DSWB07LHGFT
Rohs compliant	

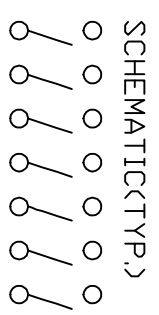
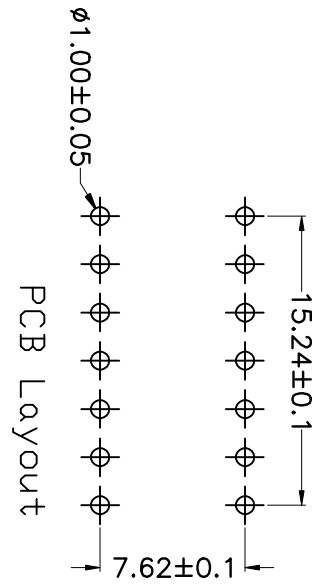
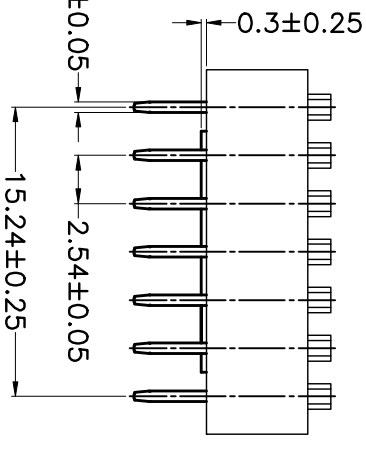
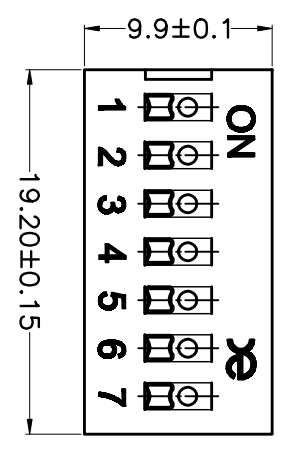
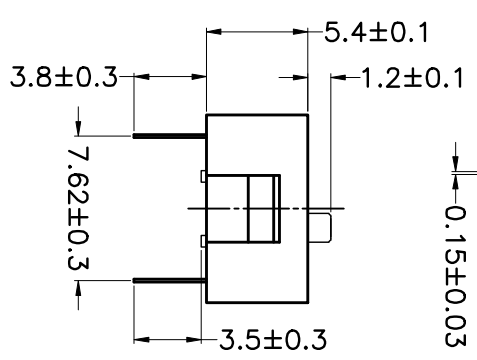
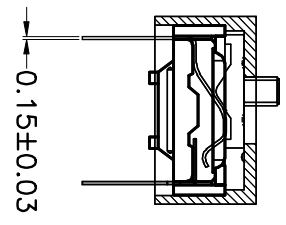

- Note:**
- All dimensions are in millimeters.
 - General tolerance: $\pm 0.2\text{mm}$.
 - Material:

Base: UL94V-0 PBT Thermoplastic (Black).
 Cover: UL94V-0 PBT Thermoplastic (Black/Red/Blue).
 Actuators: UL94V-0 PA66 Thermoplastic (White).
 Contact plating: Gold plating over nickel.
 Pitting material: Epoxy.

4. Electrical
 Electrical: 2000 Operations per switch 24/VDC, 25mA.
 Non-Switching Rating: 100mA, 50/VDC.
 Switching Rating: 25mA, 24/VDC
 Contact Resistance: 100 mΩ Max at initial.

5. Mechanical
 Mechanical life: 2000 Operations per switch.
 Stroke: 2.0mm.
 Operation Temp: -20°C to 70°C.
 Storage Temp: -40°C to 85°C.

6. PART NUMBER DESCRIPTION:

DS WB 07 L H G E T

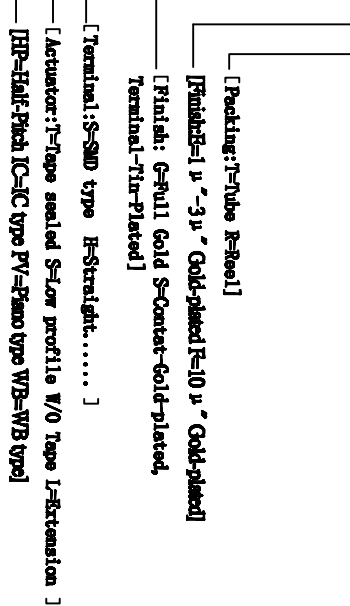

TOLERANCE UNLESS OTHERWISE SPECIFIED		INSPECTION COPY		PROJECTION		TITLE	
LINER	ANGLES	0 ± 0.30	0 ± 1°			BY DSWB SERIES PITCH 2.54mm	
.00 ± 0.20	.0 ± 0.5°					PRODUCT FAMILY DSWB SERIES	
.000 ± 0.10	.00 ±					PRAT NO. DSWB07LHGFT	
DESIGN	LU ER XIN	2013/07/02				FILE NO. DSWB07LHGFT-A	
DRAWING						SIZE UNIT SCALE SHEET REV.	
CHECK						A4 mm FIT TOP 1 A	
APPRO.							

东莞市富实业有限公司
 Dongguan Kingtek Industrial Co., Ltd.

单击下面可查看定价，库存，交付和生命周期等信息

[>>KINGTEK\(广督\)](#)