

PRODUCT NO.	DISCO4LHGET
RoHS compliant	

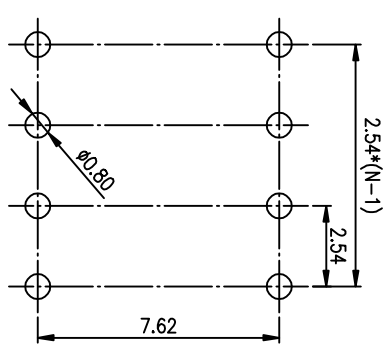

RECOMMENDED P.C.B. LAYOUT (TOP VIEW)

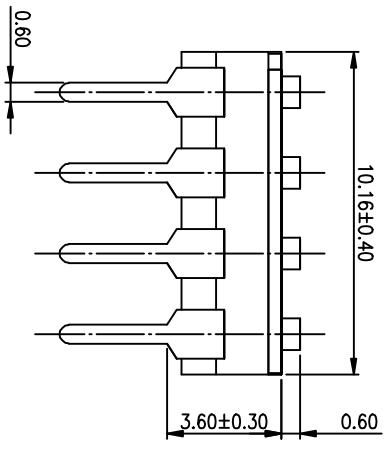
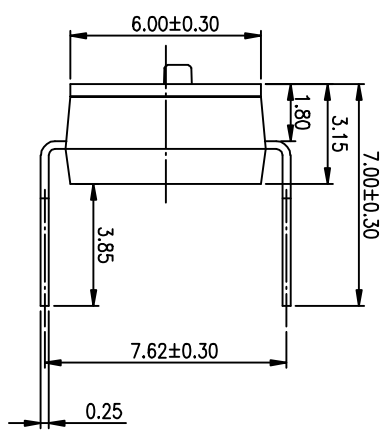
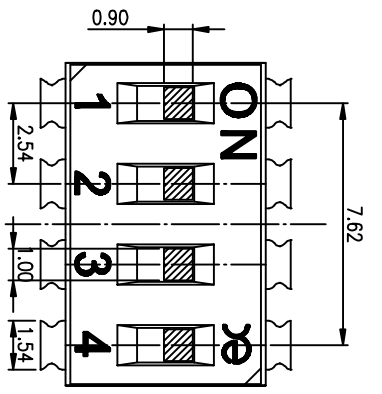
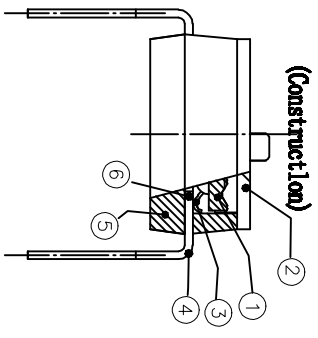

(Construction)

REV.	ECN NO.	DR.	DATE

- NOTES :**
- 1> Specification:
 - 1> Operating force: 1000gf Max
 - 2> Operating Temperature: -40° to +85°
 - 3> Storage Temperature: -40° to +85°
 - 4> Mechanical Life: 3000cycles minimum
 - 5> Electrical Life: 2000cycles 25mA 24VDC
 2. PLATING:
 - GOLD FLASH 1u"(min.) SOLDER TAIL,
 - 3u" GOLD PLATING ON THE CONTACT AREA,
 - WITH 50u" NICKEL UNDERPLATING OVERALL.

3. PART NUMBER DESCRIPTION

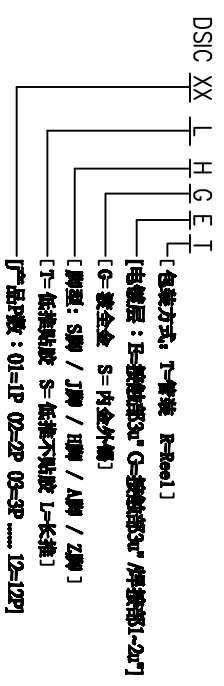

[Schematic]

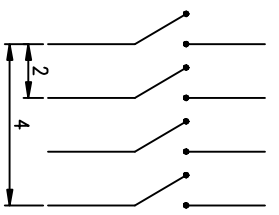

[推板行程]

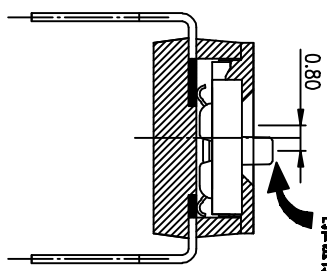

Number	Part Name	Material	Finished
①	Actuator	UL94 V0	White
②	Cover	UL94 V0	Black
③	Movable	Copper Alloy	3u"Gold
④	Terminal	Brass	1u"Gold
⑤	Base	UL94 V0	Black
⑥	Terminal Contact	Brass	3u"Gold

TOLERANCE UNLESS OTHERWISE SPECIFIED		INSPECTION COPY	
LINE	ANGLES	PROJECTION	COPY
0 ± 0.25	0 ± 2'	1	
.00 ± 0.15	.0 ± 1'		
.000 ± 0.10	.00 ± 0.5'		

DESIGN	2012/04/12
DRAWING	
CHECK	
APPRO.	

FILE NO.	DISCO4LHGET-A
SIZE	UNIT SCALE SHEET REV.
A4	mm 2 : 1 1 OF 1 A

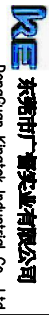

东莞市金捷实业有限公司
Dongguan Kingtek Industrial Co., Ltd.

BY DISC SERIES PITCH 2.54mm

PRODUCT FAMILY DISC SERIES

PRAT NO. DISCO4LHGET

DISCO4LHGET

单击下面可查看定价，库存，交付和生命周期等信息

[>>KINGTEK\(广督\)](#)