

PRODUCT NO.	RoHS compliant
DSIC12LSGET	

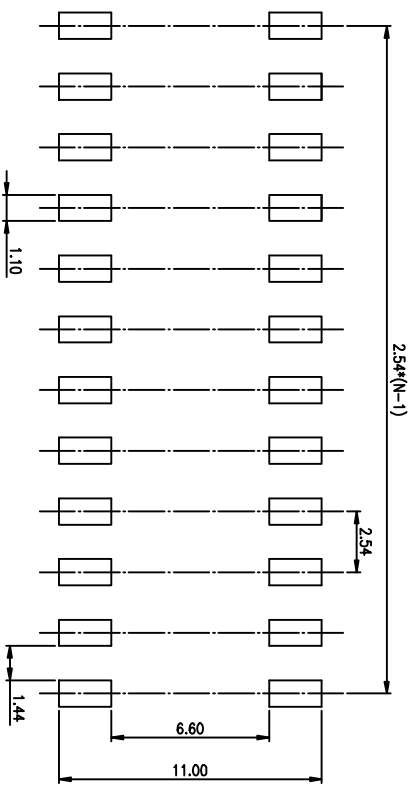

- NOTES :
- 1> Specification:
    - 1> Operating force: 1000gf Max
    - 2> Operating Temperature: -40° to +85°
    - 3> Storage Temperature: -40° to +85°
    - 4> Mechanical Life: 3000cycles minimum
    - 5> Electrical Life: 2000cycles minimum
  2. PLATING:
    - GOLD FLASH 1u"(min.) SOLDER TAIL,
    - 3u" GOLD PLATING ON THE CONTACT AREA,
    - WITH 50u" NICKEL UNDERPLATING OVERALL.

3. PART NUMBER DESCRIPTION

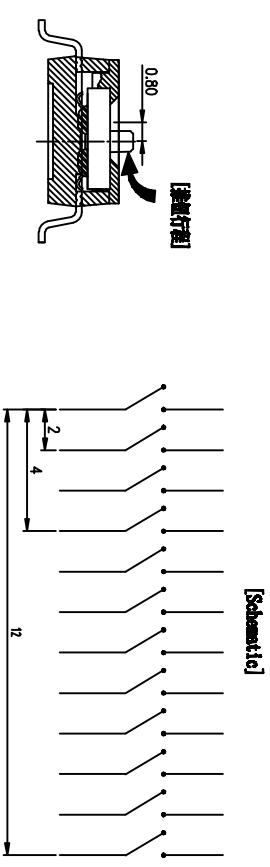
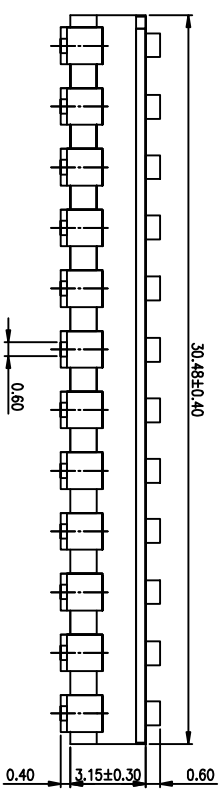
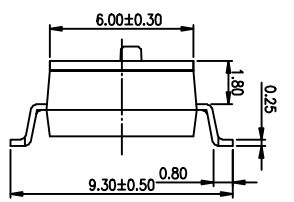
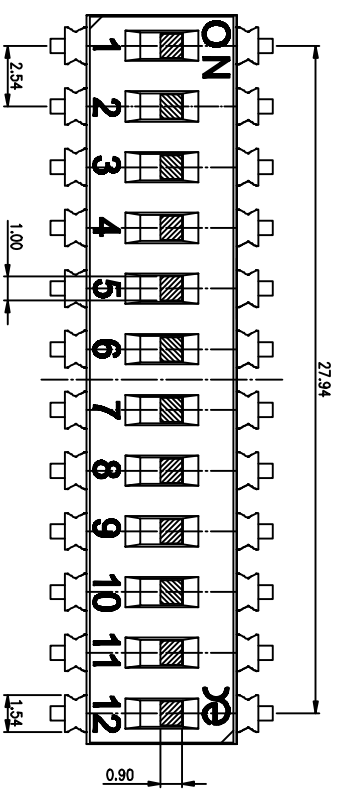
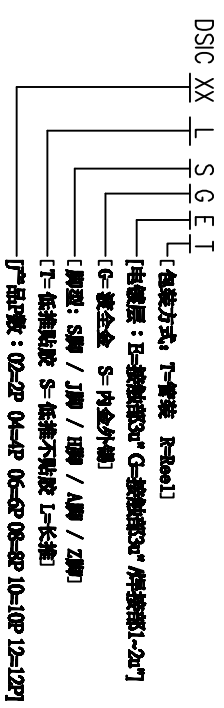

RECOMMENDED P.C.B. LAYOUT (TOP VIEW)

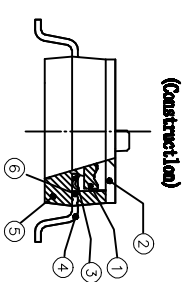

Number	Part Name	Material	Finished
①	Actuator	UL94 V0	White
②	Cover	UL94 V0	Black
③	Movable	Copper Alloy	3u"Gold
④	Terminal	Brass	1u"Gold
⑤	Base	UL94 V0	Black
⑥	Terminal Contact	Brass	3u"Gold

TOLERANCE UNLESS OTHERWISE SPECIFIED		INSPECTION	
LINER	ANGLES	COPY	PROJECTION
0 ± 0.25	0. ± 2°		
.00 ± 0.15	.0 ± 1°		
.000 ± 0.10	.00 ± 0.5°		
DESIGN	kathy	2012/04/12	
DRAWING			
CHECK			
APPRO.			

东莞市广客实业有限公司 Dongguan Kingtek Industrial Co., Ltd.			
TITLE			
BY DSIC SERIES PITCH 2.54mm			
PRODUCT FAMILY DSIC SERIES			
FILE NO.	DSIC12LSGET-A		
SIZE	UNIT	SCALE	SHEET
A4	mm	2 : 1	1 OF 1

单击下面可查看定价，库存，交付和生命周期等信息

[>>KINGTEK\(广督\)](#)