

PRODUCT NO. DSIC121HGCT	RoHS compliant
-----------------------------------	-----------------------

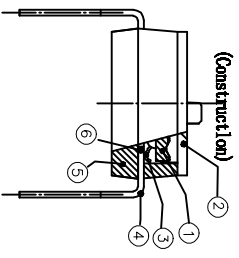

- NOTES :
- 1> Specification:
 - 1> Operating force: 1000gf Max
 - 2> Operating Temperature: -40° to +85°
 - 3> Storage Temperature: -40° to +85°
 - 4> Mechanical Life: 3000cycles minimum
 - 5> Electrical Life: 2000cycles 25mA 24VDC
 2. PLATING:

GOLD FLASH 1u"(min.) SOLDER TAIL,
3u" GOLD PLATING ON THE CONTACT AREA,
WITH 50u" NICKEL UNDERPLATING OVERALL.
 3. PART NUMBER DESCRIPTION

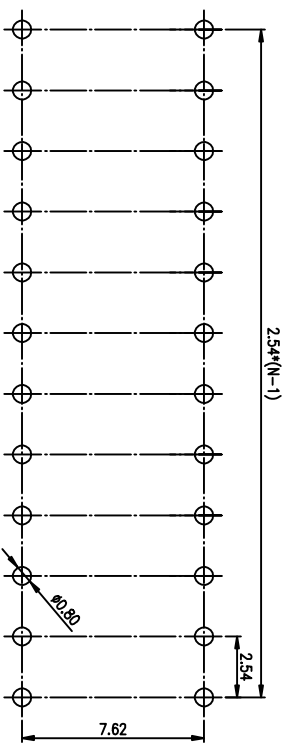
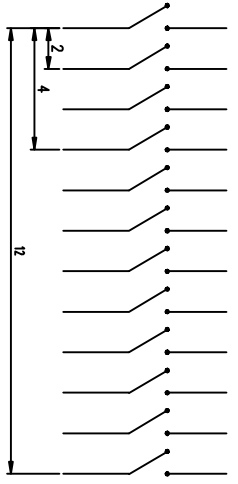
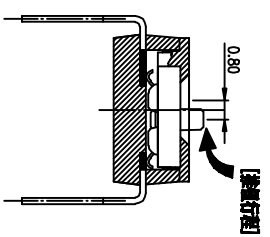
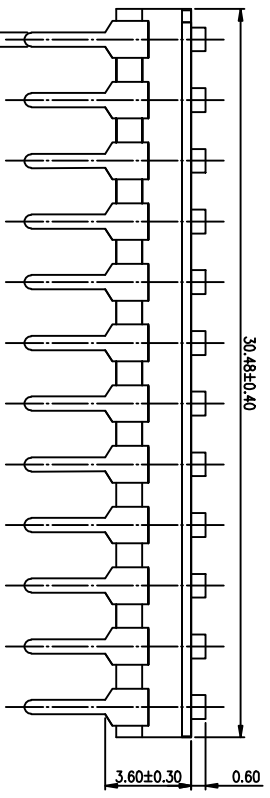
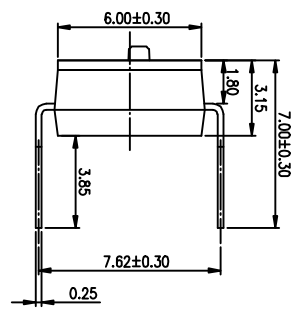
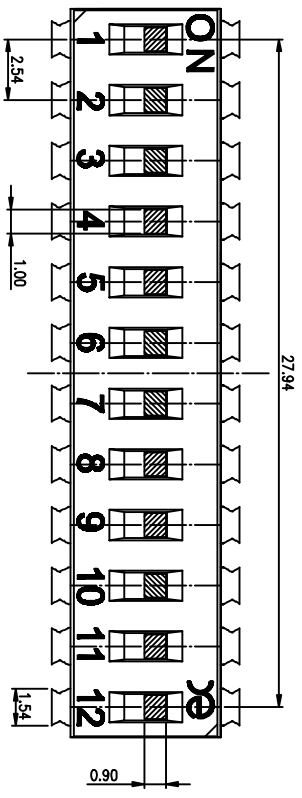
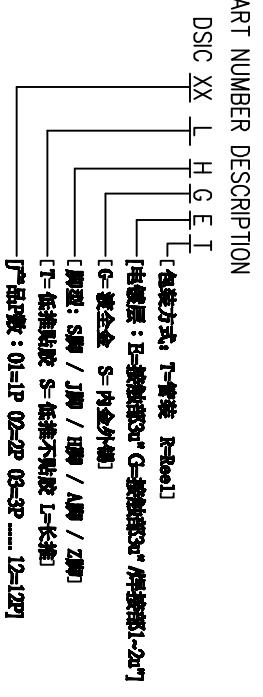

Number	Part Name	Material	Finished
①	Actuator	UL94 V0	White
②	Cover	UL94 V0	Black
③	Movable	Copper Alloy	3u"Gold
④	Terminal	Brass	1u"Gold
⑤	Base	UL94 V0	Black
⑥	Terminal Contact	Brass	3u"Gold

TOLERANCE UNLESS OTHERWISE SPECIFIED	INSPECTION COPY
LINER 0 ± 0.25	ANGLES 0. ± 2'
.00 ± 0.15	.0 ± 1'
.000 ± 0.10	.00 ± 0.5'

PROJECTION	TITLE
BY DSIC SERIES PITCH 2.54mm	東莞市 睿業工業有限公司 Dongguan Kingtek Industrial Co., Ltd.
PRODUCT FAMILY DSIC SERIES	PRAT NO. DSIC121HGCT
FILE NO. DSIC121HGCT-A	SIZE UNIT SCALE SHEET REV.
CHECK	A4 mm 2 : 1 1 OF 1 A
APPRO.	

单击下面可查看定价，库存，交付和生命周期等信息

[>>KINGTEK\(广督\)](#)