

Dual Transient Voltage Suppressors for ESD Protection

Features

- SOT-23 Package
- 2 Unidirectional Transil functions
- Peak Power Dissipation 300W @8 x 20 us Pulse
- Low Leakage
- Fast Response Time < 1 ns
- Protects I/O Port
- ESD Protection to IEC 61000-4-2 Level 4,15KV(Air), 8KV(Contact)
- 16KV Human Body Model ESD Requirements
- RoHS Compliant in Lead-Free Versions

SOT-23

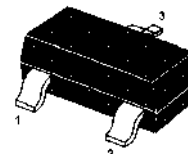

1. BASE
2. EMITTER
3. COLLECTOR

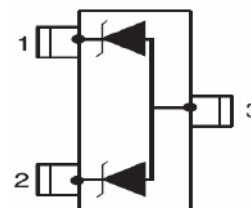

Applications

- Computers
- Printers
- Communication Systems

Absolute Maximum Ratings

Symbol	Parameter	Value	Units
P_{PP}	Peak Pulse Power ($t_p = 8/20\mu s$)	300	W
T_L	Maximum lead temperature for soldering during 10s	260	°C
T_{stg}	Storage Temperature Range	-55 to +15	°C
T_{op}	Operating Temperature Range	-40 to +125	°C
T_j	Maximum junction temperature	150	°C
V_{PP}	Electrostatic discharge		
	MIL STD 883C -Method 3015-6	25	kv
	IEC61000-4-2 air discharge	16	
IEC61000-4-2 contact discharge	9		

Electrical Characteristics

Symbol	Parameter
V_{RM}	Stand-off voltage
V_{BR}	Breakdown voltage
V_{CL}	Clamping voltage
I_{RM}	Leakage current
I_{PP}	Peak pulse current
αT	Voltage temperature coefficient
V_F	Forward voltage drop
C	Capacitance
R_d	Dynamic resistance

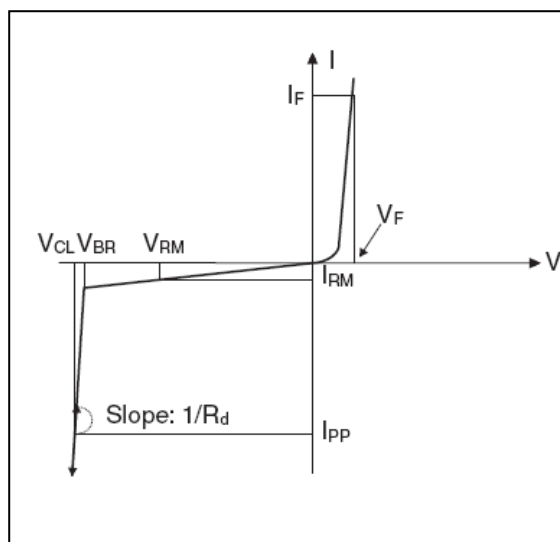

Electrical Characteristics Ratings at 25°C ambient temperature unless otherwise specified.

Part Numbers	Marking	Rated Stand-off Voltage	Maximum Leakage Current	Minimum Breakdown Voltage	Maximum Clamping Voltage		Maximum Pulse Peak Current	Maximum Capacitance
			@ V_{RM}	1mA	1A ¹⁾	5A ¹⁾	tp=8/20us	0v, 1MHz
		V_{RM}	I_{RM}	V_{BR}	V_{CL}		I_{PPM}	C
		V	μA	V	V	V	A	pF
PESD5V0S2BT	05C	5.0	1.0	6.0	9.8	12.5	17	220

Typical Characteristics

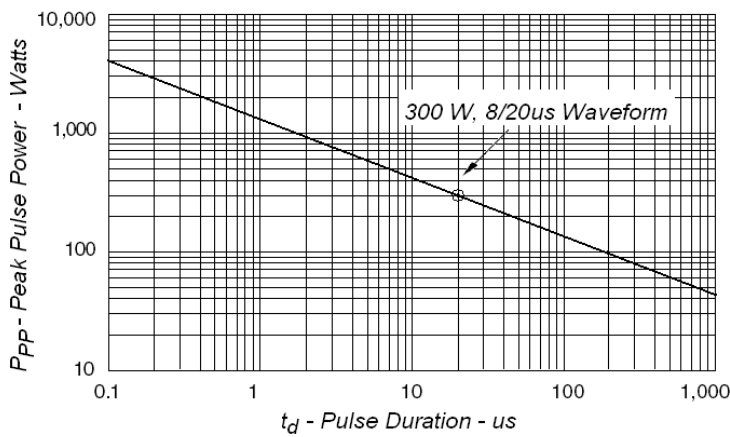

Fig1. Peak Pulse Power VS Pulse Time

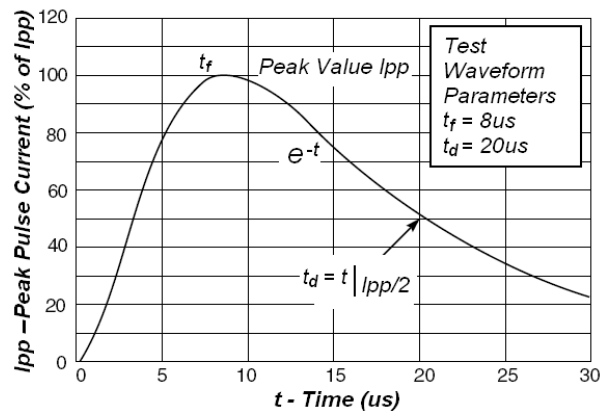

Fig2. Pulse Waveform

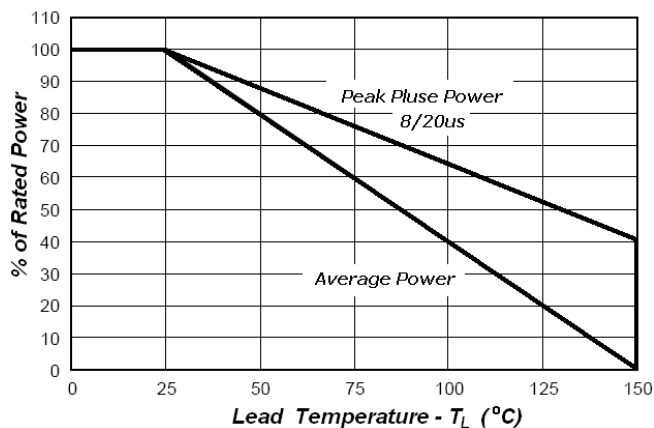
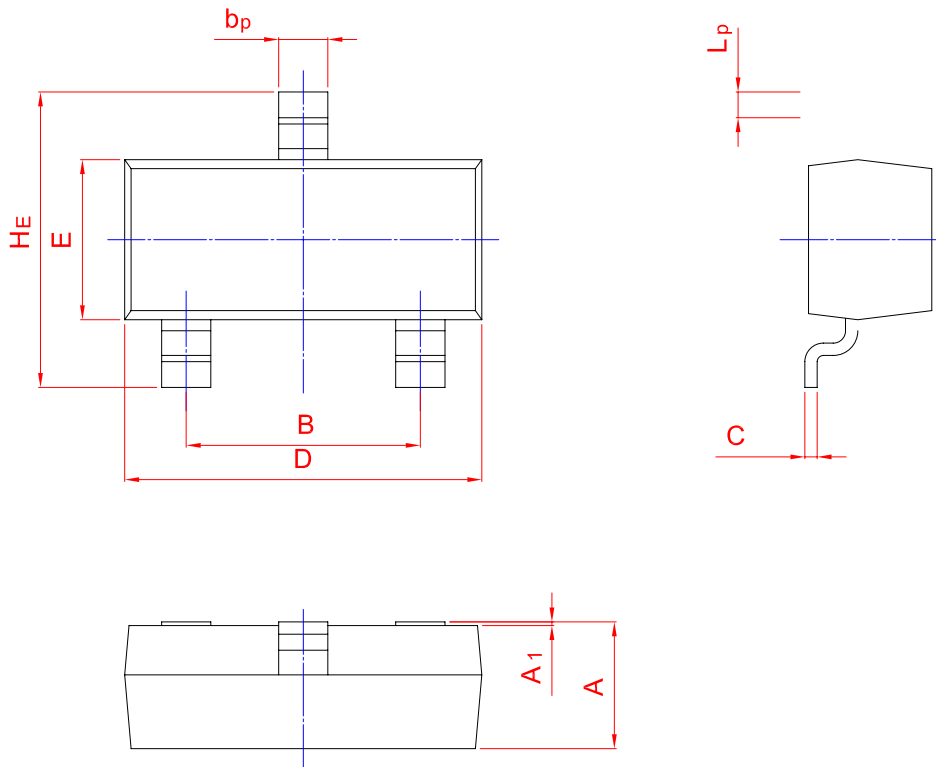
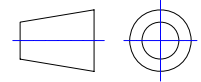

Fig3. Power Derating

PACKAGE OUTLINE

Plastic surface mounted package; 3 leads

SOT-23



UNIT	A	B	bp	C	D	E	HE	A1	Lp
mm	1.40	2.04	0.50	0.19	3.10	1.65	3.00	0.100	0.50
	0.95	1.78	0.35	0.08	2.70	1.20	2.20	0.013	0.20

单击下面可查看定价，库存，交付和生命周期等信息

[>>KUU\(永裕泰\)](#)