

DESCRIPTION

KSDxxC is designed for applications requiring transient overvoltage protection capability. They are intended for use in voltage and ESD sensitive equipment such as computers, printers, business machines, communication systems, medical equipment and other applications. These devices are ideal for situations where board space is at a premium.

This series has been specifically designed to protect sensitive components which are connected to power, data and transmission lines from overvoltage caused by ESD (electrostatic discharge), CDE (Cable Discharge Events), and EFT (electrical fast transients).

ORDERING INFORMATION

- ✧ Package: SOD-323
- ✧ Material: Halogen free
- ✧ Packing: Tape & Reel
- ✧ Quantity per reel: 3,000pcs

PIN CONFIGURATION

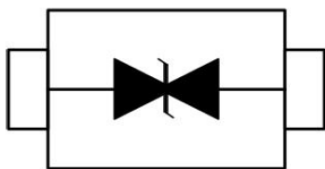

FEATURES

- ✧ IEC61000-4-2 (ESD) $\pm 15\text{kV}$ (air), $\pm 8\text{kV}$ (contact)
- ✧ IEC61000-4-4 (EFT) 40A (5/50ns)
- ✧ 350 Watts Peak Pulse Power per (tp=8/20 μ s)
- ✧ Protects one I/O line (bidirectional)
- ✧ Low clamping voltage
- ✧ Low leakage current

MACHANICAL DATA

- ✧ SOD-323 package
- ✧ Flammability Rating: UL 94V-0
- ✧ Packaging: Tape and Reel
- ✧ High temperature soldering guaranteed: 260°C/10s
- ✧ Reel size: 7 inch

APPLICATIONS

- ✧ Cell Phone Handsets and Accessories
- ✧ Microprocessor based equipment
- ✧ Personal Digital Assistants (PDA's)
- ✧ Notebooks, Desktops, and Servers
- ✧ Portable Instrumentation
- ✧ Networking and Telecom
- ✧ Serial and Parallel Ports.
- ✧ Peripherals

PACKAGE OUTLINE

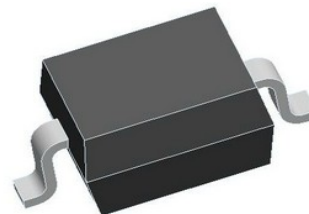

ABSOLUTE MAXIMUM RATING

Symbol	Parameter	Value	Units
V_{ESD}	ESD per IEC 61000-4-2 (Air) ESD per IEC 61000-4-2 (Contact)	± 15 ± 8	kV
P_{PP}	Peak Pulse Power (8/20 μ s)	350	W
T_{OPT}	Operating Temperature	-55/+150	$^{\circ}$ C
T_{STG}	Storage Temperature	-55/+150	$^{\circ}$ C
T_L	Lead Soldering Temperature	260 (10 sec.)	$^{\circ}$ C

ELECTRICAL CHARACTERISTICS ($T_{amb}=25^{\circ}$ C)

PART NUMBER	DEVICE MARKING	V_{RWM}	V_B	I_T	$V_C@1A$	V_C		I_R	C_T
		(V) (max.)	(V) (min.)	(mA)	(V) (max.)	(V) (max.)	(@A)	(μ A) (max.)	(pF) (max.)
KSD03C	2A	3.3	4.0	1	7.5	10.5	20	40	450
KSD05C	2B	5.0	6.0	1	9.8	18.0	17	10	200
KSD12C	2D	12.0	13.3	1	19.0	32.0	11	1	75
KSD15C	2J	15.0	16.7	1	24.0	38.0	10	1	68
KSD18C	2K	18.0	20.0	1	29.0	45.0	9	1	57
KSD24C	2H	24.0	26.7	1	43.0	52.0	7	1	50
KSD36C	2N	36.0	40.0	1	60.0	75.0	5	1	35

ELECTRICAL CHARACTERISTICS CURVE

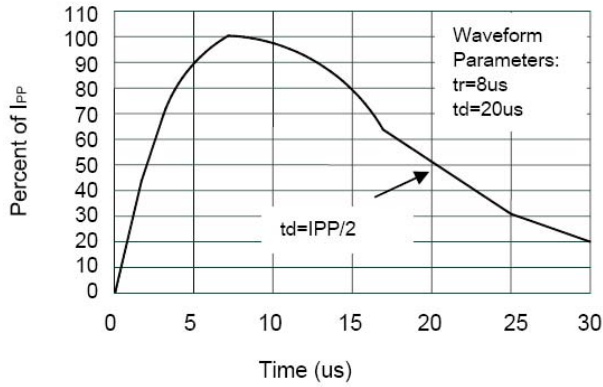

Pulse Waveform

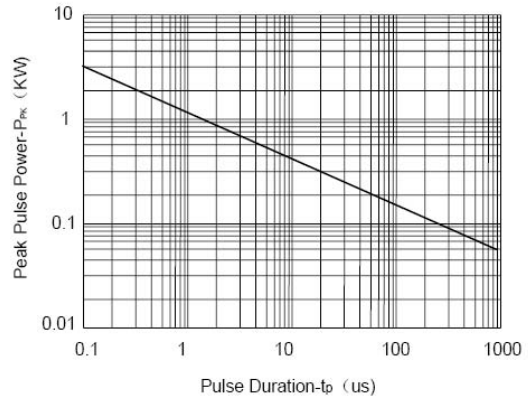

Non-Repetitive Peak Pulse Power vs. Pulse Time

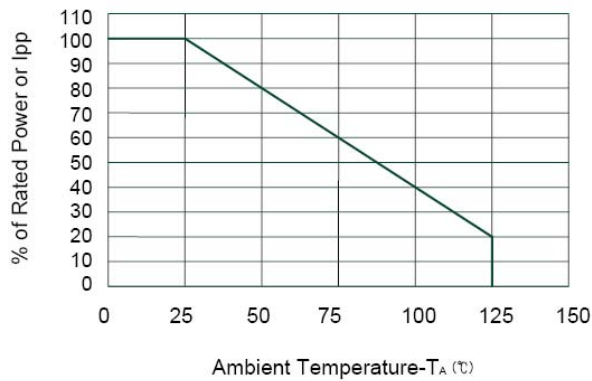

Power Derating Curve

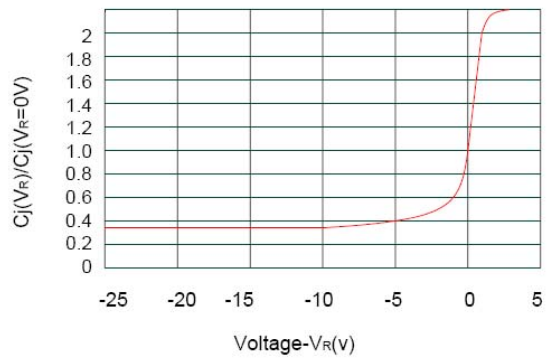

Junction Capacitance vs. Reverse Voltage

SOD-323 PACKAGE OUTLINE DIMENSIONS

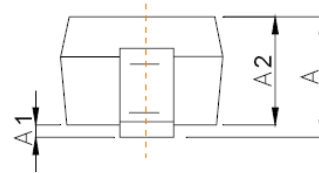
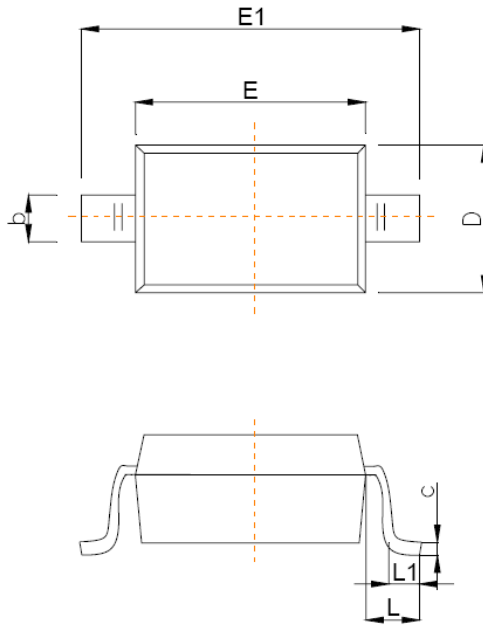

Symbol	Dimensions In Millimeters	
	Min	Max
A		1.00
A1	0.000	0.100
A2	0.800	0.900
b	0.250	0.350
c	0.080	0.150
D	1.200	1.400
E	1.600	1.800
E1	2.500	2.700
e	1.800	2.040
L	0.475 REF	
L1	0.250	0.400
θ	0°	8°

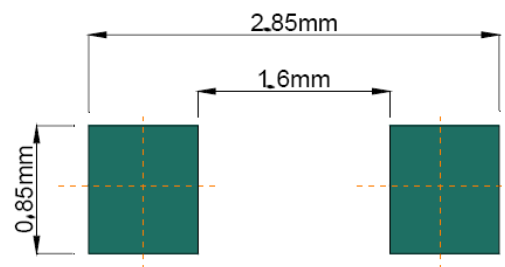

Recommended Pad outline

单击下面可查看定价，库存，交付和生命周期等信息

[>>KUU\(永裕泰\)](#)