

DESCRIPTION

The GBLCxxCI are ultra low capacitance transient voltage suppressor arrays, designed to protect applications such as portable electronics and SMART phones. This series is available in both unidirectional and bidirectional configurations and is rated at 350 Watts for an 8/20µs wave shape.

The GBLCxxCI meets IEC 61000-4-2 (ESD) and IEC 61000-4-4 (EFT) requirements. At higher operating frequencies or faster edge rates, insertion loss and signal integrity are a major concern. This series offers a ultra low capacitance and low leakage current in a miniature SOD-323 package.

FEATURES

- ✧ Transient protection for high-speed data lines
IEC 61000-4-2 (ESD) ±8kV (Contact)
±15kV (Air)
IEC 61000-4-4 (EFT) 40A (5/50 ns)
- ✧ Protects one I/O line (bidirectional)
- ✧ Working voltages : 3V, 5V, 8V, 12V, 15V, 18V, 20V, 24V, 36V
- ✧ Low clamping voltage
- ✧ Low leakage current
- ✧ Response time is < 1 ns

MACHANICAL DATA

- ✧ SOD-323 package
- ✧ Flammability Rating: UL 94V-0
- ✧ Packaging: Tape and Reel
- ✧ High temperature soldering guaranteed:
260°C/10s
- ✧ Reel size: 7 inch
- ✧ MSL1

ORDERING INFORMATION

- ✧ Device: GBLCxxCI
- ✧ Package: SOD-323
- ✧ Material: Halogen free
- ✧ Packing: Tape & Reel
- ✧ Quantity per reel: 3,000pcs

APPLICATIONS

- ✧ Cell Phone Handsets and Accessories
- ✧ Microprocessor based equipment
- ✧ Personal Digital Assistants (PDA's)
- ✧ Notebooks, Desktops, and Servers
- ✧ Portable Instrumentation
- ✧ Peripherals
- ✧ USB Interface

PIN CONFIGURATION

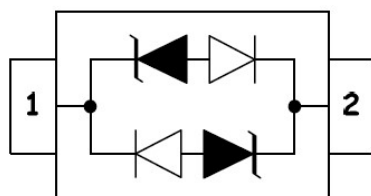

PACKAGE OUTLINE

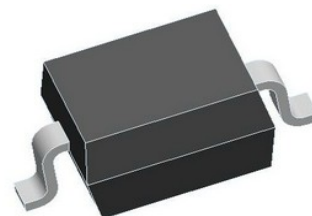

ABSOLUTE MAXIMUM RATING

Symbol	Parameter	Value	Units
V_{ESD}	ESD per IEC 61000-4-2 (Air)	± 15	kV
	ESD per IEC 61000-4-2 (Contact)	± 8	
P_{PP}	Peak Pulse Power (8/20 μ s)	350	W
T_{OPT}	Operating Temperature	-55/+150	$^{\circ}$ C
T_{STG}	Storage Temperature	-55/+150	$^{\circ}$ C
T_L	Lead Soldering Temperature	260	$^{\circ}$ C

ELECTRICAL CHARACTERISTICS (Tamb=25 $^{\circ}$ C)

PART NUMBER	DEVICE MARKING	V_{RWM}	$V_B@1mA$	$V_C@1A$	$V_C@I_{pp}$		$V_C@I_{pp}$		I_R (μ A)	C_T (pF)
		Max	Min	Max	Max	I_{pp} (A)	Max	I_{pp} (A)		
GBLC03CI	CC	3.0	4.0	7.0	13.9	8	20.0	20	5	0.8
GBLC05CI	AC	5.0	6.0	9.8	18.3	8	20.0	18	1	0.8
GBLC08CI	BC	8.0	8.5	13.4	18.5	8	24.0	18	1	0.8
GBLC12CI	DC	12.0	13.3	19.0	24.0	6	28.6	12	1	0.8
GBLC15CI	EC	15.0	16.7	24.0	29.0	5	31.8	10	1	0.8
GBLC18CI	FC	18.0	20.0	35.0	45.0	5	53.0	7	1	0.8
GBLC20CI	GC	20.0	22.0	38.0	45.0	4	55.0	7	1	0.8
GBLC24CI	HC	24.0	26.7	43.0	45.0	3	56.0	6	1	0.8
GBLC36CI	IC	36.0	40.0	60.0	65.0	2	75.0	4.5	1	0.8

ELECTRICAL CHARACTERISTICS CURVE

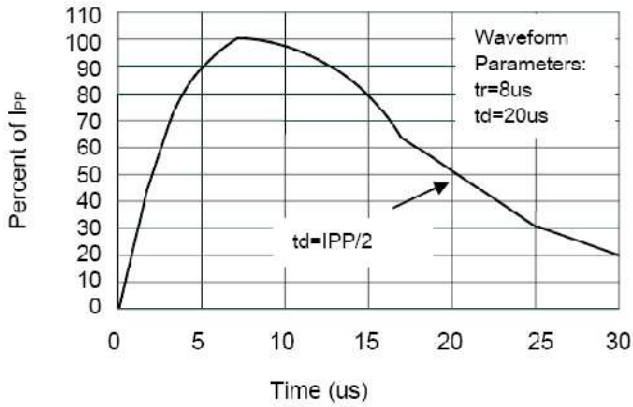

Pulse Waveform

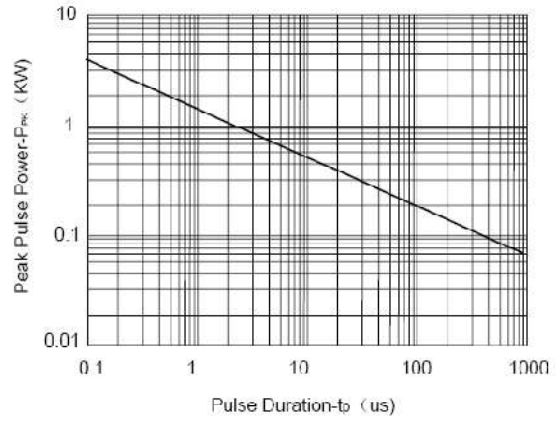

Non-Repetitive Peak Pulse Power vs. Pulse Time

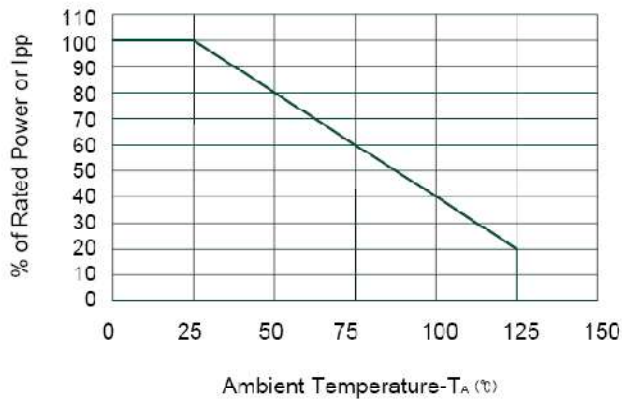

Power Derating Curve

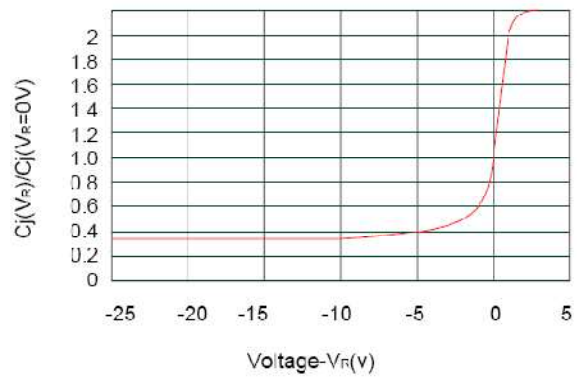

Junction Capacitance vs. Reverse Voltage

SOD-323 PACKAGE OUTLINE DIMENSIONS

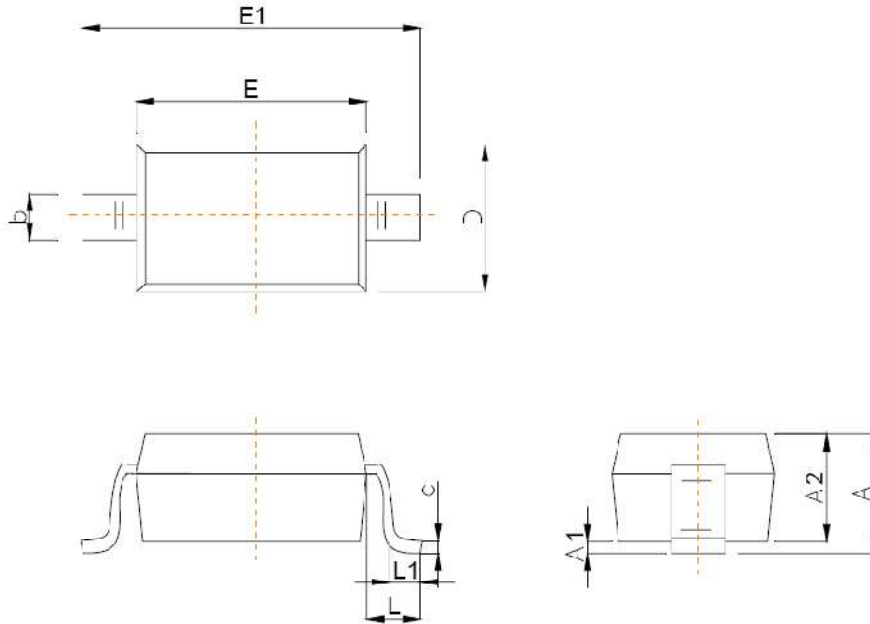

Symbol	Dimensions In Millimeters	
	Min	Max
A		1.00
A1	0.000	0.100
A2	0.800	0.900
b	0.250	0.350
c	0.080	0.150
D	1.200	1.400
E	1.600	1.800
E1	2.500	2.700
e	1.800	2.040
L	0.475 REF	
L1	0.250	0.400
θ	0°	8°

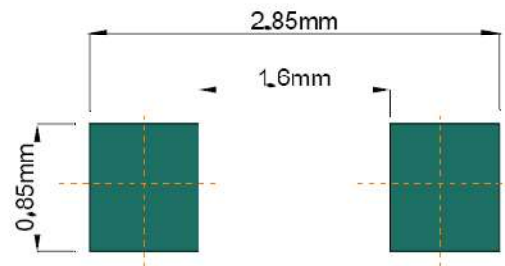

Recommended Pad outline

单击下面可查看定价，库存，交付和生命周期等信息

[>>KUU\(永裕泰\)](#)