

**Description**

The KESDU5V0 is a polymeric ESD suppressor help protect sensitive electronic equipment against electrostatic discharge (ESD) without distorting data signals. This protection is a result of its ultra-low capacitance of only 0.05 pF (I/O to GND), and it can be used to help equipment to pass IEC61000-4-2 level 4 test (15KV air, 8KV contact discharge).

(EIA Size) 0402



**Features**

- ◆ Ultra low capacitance,0.05pF(typ.).
- ◆ Fast response time(<1ns).
- ◆ Low leakage current(<10nA).
- ◆ Bi-directional, single line protection.
- ◆ IEC61000-4-2(Contact): 8KV, IEC61000-4-2(Air) :15KV.

**Equivalent Circuit**

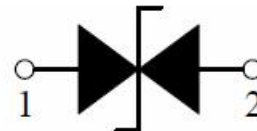

**Applications**

- ◆ Smart Phone/Mobile Internet Device.
- ◆ Laptop/Desktop Computer.
- ◆ Antennas (Cell Phones, GPS...).
- ◆ USB 3.0,USB 3.1 and high speed interface.

**General Characteristics**

Parameter	Max	Unit
Contact Discharge Voltage Per IEC61000-4-2	8	KV
Air Discharge Voltage Per IEC61000-4-2	15	KV
Operating Temperature	-55 to +125	°C
Storage Temperature	-40 to +85	°C

**Electrical Characteristics (T<sub>A</sub> = 25°C)**

Parameter	Symbol	Test Conditions	Min.	Typ.	Max.	Units
Continuous Operating Voltage	V <sub>DC</sub>	--	--	--	5	V
Trigger Voltage	V <sub>T</sub>	IEC61000-4-2 8KV contact discharge	--	450	--	V
Clamping Voltage	V <sub>C</sub>	IEC61000-4-2 8KV contact discharge	--	40	--	V
Leakage Current	I <sub>L</sub>	DC 5V shall be applied on component	--	--	10	nA
Capacitance	C <sub>P</sub>	Measured at 10MHz	--	0.05	--	pF
ESD Pulse Withstand	Pulses	IEC61000-4-2 8KV contact discharge	1000	--	--	--

**Note:**

Trigger and clamping voltage are measured per IEC 61000-4-2, 8KV contact discharge method.

**Typical ESD Response (IEC 61000-4-2, 8KV contact discharge)**

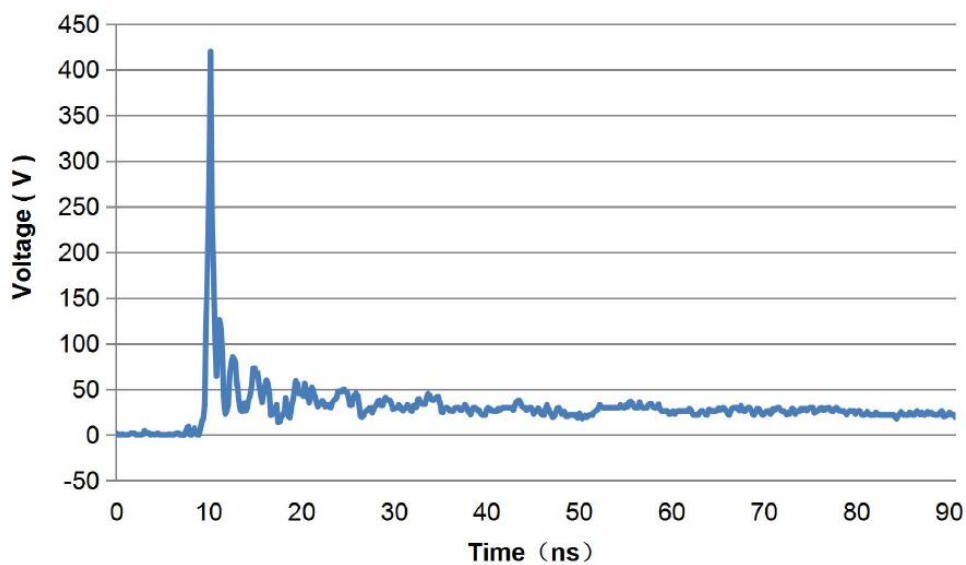
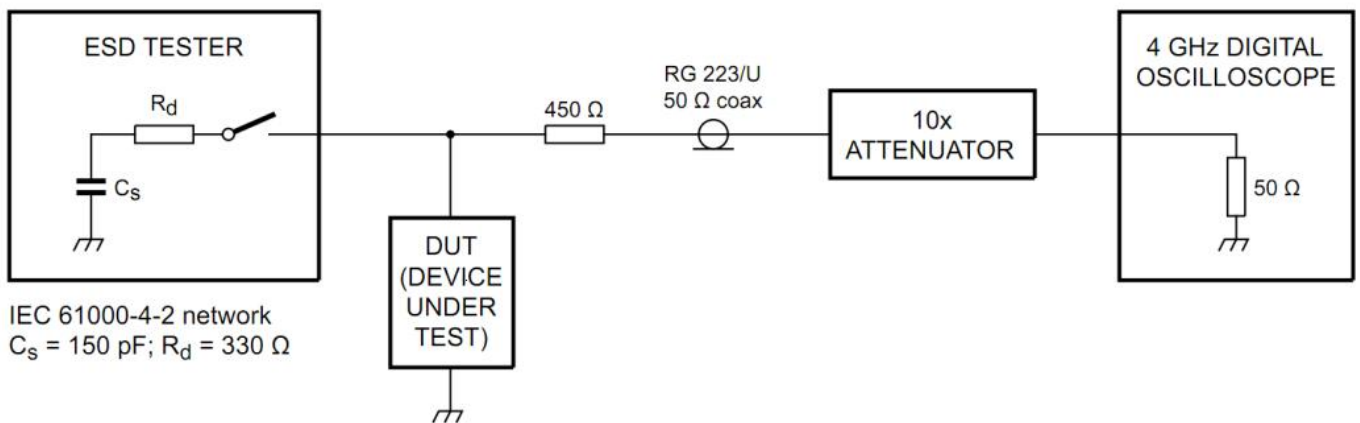

Typical Device Capacitance VS. Frequency

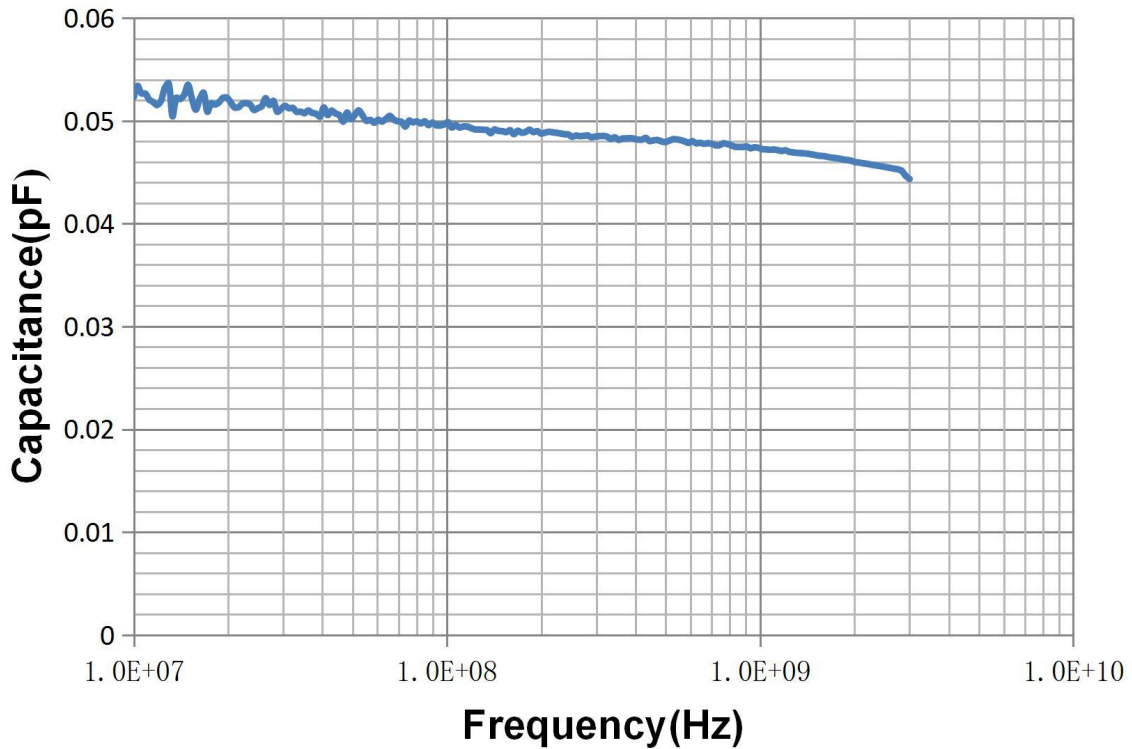

Soldering Parameters

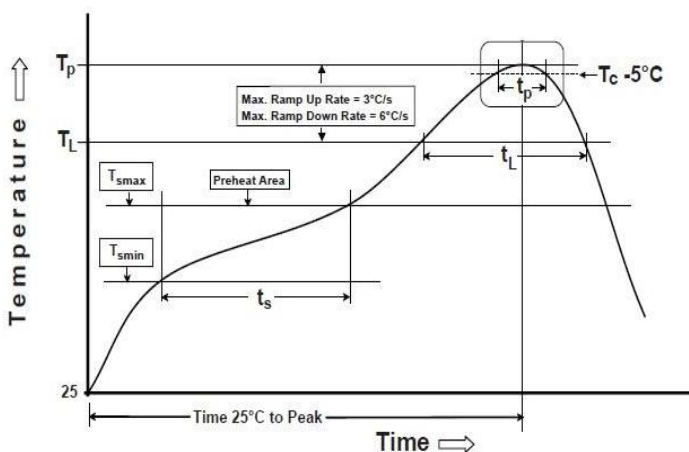

Profile Feature		Pb-Free Assembly
Pre Heat	Temperature Min ( $T_{smin}$ )	150°C
	Temperature Max ( $T_{smax}$ )	200°C
	Time ( $T_s$ ) from ( $T_{smin}$ to $T_{smax}$ )	60-120 seconds
Ramp-up Rate ( $T_L$ to $T_P$ )		3°C/second max.
Liquidus Temperature ( $T_L$ )		217°C
Time ( $t_L$ ) maintained above $T_L$		60-150 seconds
Peak Package Body Temperature ( $T_P$ )		260 <sup>+0/-5</sup> °C
Time ( $t_p$ )* within 5°C of the Specified Classification Temperature ( $T_c$ )		30* seconds
Ramp-down Rate ( $T_P$ to $T_L$ )		6°C/second max.
Time 25°C to peak Temperature		8 minutes Max

\* Tolerance for peak profile temperature ( $T_P$ ) is defined as a supplier minimum and a user maximum.

**Package Dimension**

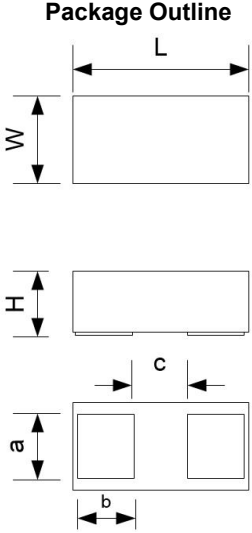

Dimension	Unit: Millimeters		
	Min.	Typ.	Max.
<b>L</b>	0.98	1.00	1.03
<b>W</b>	0.48	0.50	0.53
<b>H</b>	0.35	0.38	0.40
<b>a</b>	0.35	0.38	0.40
<b>b</b>	0.30	0.30	0.35
<b>c</b>	0.24	0.26	0.29

**Recommended Solder Pad Footprint**

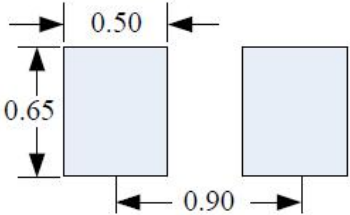

Sizes in mm

**Notes:**

This solder pad layout is for reference purposes only.

单击下面可查看定价，库存，交付和生命周期等信息

[>>KUU\(永裕泰\)](#)