

外形尺寸 Shape and Dimensions

- 尺寸：见图 1 和表 1
- PCB 焊盘：见图 2 和表 1
- Dimensions: See Fig.1 and Table 1.
- Recommended PCB pattern for reflow soldering: See Fig.2 and Table 1



图 1 Fig.1



图 2 Fig.2

表 1 (Table 1)

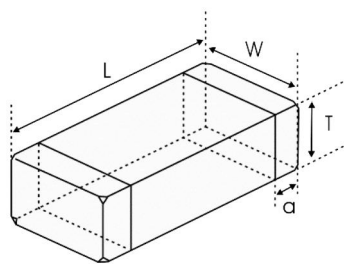
单位 unit: inch[mm]

类别 Type	L	W	T	a	A	B	C
0603 [1608]	0.063±0.006 [1.6±0.15]	0.031±0.006 [0.8±0.15]	0.031±0.006 [0.8±0.15]	0.012±0.008 [0.3±0.2]	[0.6-0.8]	[0.6-0.7]	[0.6-0.8]

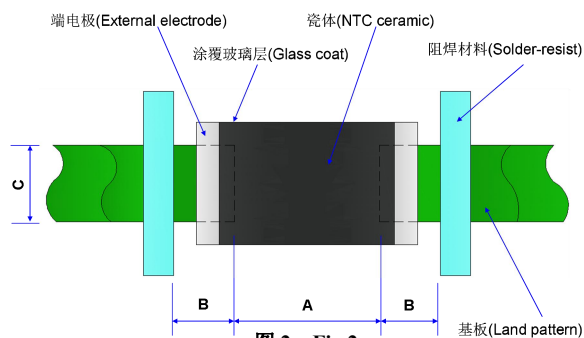
电气特性 Electrical Characteristics

型号 Part No	电阻值 Resistance (25°C) (kΩ)	B 常数 B Constant (25/50°C) (K)	B 常数 B Constant (25/85°C) (K)	允许工作电流 Permissible Operating Current (25°C) (mA)	耗散系数 Dissipation Factor (mW/°C)	热时间常数 Thermal Time Constant (s)	额定功率 Rated Electric Power(25°C) (mW)	工作温度 Operating ambient temperature (°C)
KNTC0603/30KJ3950	30±5%	3950±1%	3987	0.18	1.0	<5	100	-40~+125

检验和测试程序

测试条件

如无特别规定，检验和测试的标准大气环境条件如下：

- 环境温度：20±15℃；
- 相对湿度：65±20%；
- 气压：86 kPa~106 kPa

如果对测试结果有异议，则在下述条件下测试：

- 环境温度：25±2℃；
- 相对湿度：65±5%
- 气压：86kPa ~ 106kPa

检查设备

外观检查：20 倍放大镜；

阻值检查：热敏电阻测试仪

Test and Measurement Procedures

Test Conditions

Unless otherwise specified, the standard atmospheric conditions for measurement/test as:

- Ambient Temperature: 20±15℃
- Relative Humidity: 65±20%
- Air Pressure: 86kPa to 106kPa

If any doubt on the results, measurements/tests should be made within the following limits:

- Ambient Temperature: 25±2℃
- Relative Humidity: 65±5%
- Air Pressure: 86kPa to 106kPa

Inspection Equipment

Visual Examination: 20× magnifier

Resistance value test: Thermistor resistance tester

电性测试 Electrical Test

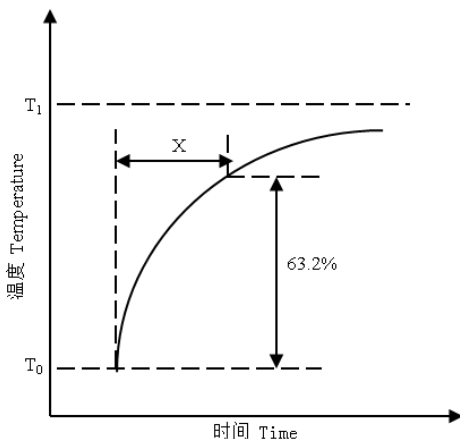
序号 No.	项目 Items	测试方法及备注 Test Methods and Remarks
1	25℃零功率电阻值 Nominal Zero-Power Resistance at 25℃(R25)	环境温度 Ambient temperature: 25±0.05℃ 测试功率 Measuring electric power: ≤0.1mW
2	B 值常数 Nominal B Constant	分别在环境温度 25±0.05℃, 50±0.05℃或 85±0.05℃下测量电阻值。 Measure the resistance at the ambient temperature of 25±0.05℃, 50±0.05℃ or 85±0.05℃. $B(25-50^{\circ}\text{C}) = \frac{\ln R_{25} - \ln R_{50}}{1/T_{25} - 1/T_{50}} \quad B(25-85^{\circ}\text{C}) = \frac{\ln R_{25} - \ln R_{85}}{1/T_{25} - 1/T_{85}}$ T: 绝对温度 (K) Absolute temperature (K)
3	热时间常数 Thermal Time Constant	在零功率条件下，当热敏电阻的环境温度发生急剧变化时，热敏电阻元件产生最初温度 T ₀ 与最终温度 T ₁ 两者温度差的 63.2% 的温度变化所需要的时间，通常以秒(S)表示。 The total time for the temperature of the thermistor to change by 63.2% of the difference from ambient temperature T ₀ (°C) to T ₁ (°C) by the drastic change of the power applied to thermistor from Non-zero Power to Zero-Power state, normally expressed in second(S). 

4	耗散系数 Dissipation Factor	在一定环境温度下，NTC 热敏电阻通过自身发热使其温度升高 1℃ 时所需要的功率，通常以 mW/℃ 表示。可由下面公式计算： The required power which makes the NTC thermistor body temperature raise 1℃ through self-heated, normally expressed in milliwatts per degree Celsius (mW/℃). It can be calculated by the following formula: $\delta = \frac{W}{T-T_0}$
5	额定功率 Rated Power	在环境温度 25℃ 下因自身发热使表面温度升高 100℃ 所需要的功率。 The necessary electric power makes thermistor's temperature rise 100℃ by self-heating at ambient temperature 25℃.
6	允许工作电流 Permissible operating current	在静止空气中通过自身发热使其升温为 1℃ 的电流。 The current that keep body temperature of chip NTC on the PC board in still air rising 1℃ by self-heating.

信赖性试验 Reliability Test

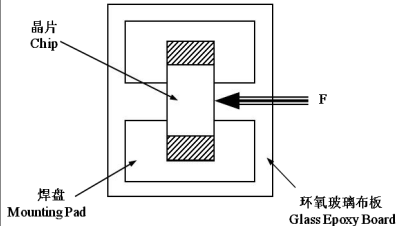
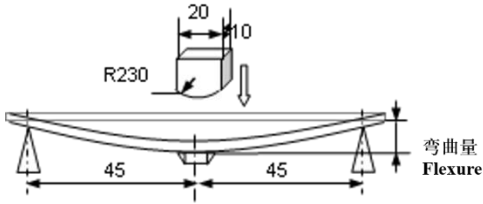
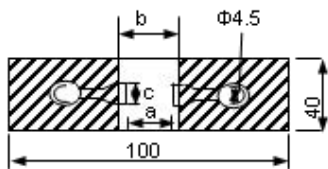
项目 Items	测试标准 Standard	测试方法及备注 Test Methods and Remarks	要求 Requirements																														
端头附着力 Terminal Strength	IEC 60068-2-21	<p>将晶片焊接在测试基板上（如右图所示的环氧玻璃布板），按箭头所示方向施加作用力； Solder the chip to the testing jig (glass epoxy board shown in the right) using eutectic solder. Then apply a force in the direction of the arrow.</p> <table border="1"> <thead> <tr> <th>尺寸 Size</th> <th>F</th> <th>保持时间 Duration</th> </tr> </thead> <tbody> <tr> <td>0201, 0402, 0603</td> <td>5N</td> <td rowspan="2">10±1s</td> </tr> <tr> <td>0805</td> <td>10N</td> </tr> </tbody> </table>	尺寸 Size	F	保持时间 Duration	0201, 0402, 0603	5N	10±1s	0805	10N	<p>端电极无脱落且瓷体无损伤。 No removal or split of the termination or other defects shall occur.</p> 																						
尺寸 Size	F	保持时间 Duration																															
0201, 0402, 0603	5N	10±1s																															
0805	10N																																
抗弯强度 Resistance to Flexure	IEC 60068-2-21	<p>将晶片焊接在测试基板上（如右图所示的环氧玻璃布板），按下图箭头所示方向施加作用力； Solder the chip to the test jig (glass epoxy board shown in the right) using a eutectic solder. Then apply a force in the direction shown as follow;</p>  <table border="1"> <thead> <tr> <th>尺寸 Size</th> <th>弯曲变形量 Flexure</th> <th>施压速度 Pressurizing Speed</th> <th>保持时间 Duration</th> </tr> </thead> <tbody> <tr> <td>0201,</td> <td>1mm</td> <td rowspan="2"><0.5mm/s</td> <td rowspan="2">10±1s</td> </tr> <tr> <td>0402, 0603, 0805</td> <td>2mm</td> </tr> </tbody> </table>	尺寸 Size	弯曲变形量 Flexure	施压速度 Pressurizing Speed	保持时间 Duration	0201,	1mm	<0.5mm/s	10±1s	0402, 0603, 0805	2mm	<p>① 无外观损伤。 No visible damage. ② $\Delta R_{25}/R_{25} \leq 5\%$</p> <p>单位 unit: mm</p> <table border="1"> <thead> <tr> <th>类型 Type</th> <th>a</th> <th>b</th> <th>c</th> </tr> </thead> <tbody> <tr> <td>0201</td> <td>0.25</td> <td>0.3</td> <td>0.3</td> </tr> <tr> <td>0402</td> <td>0.4</td> <td>1.5</td> <td>0.5</td> </tr> <tr> <td>0603</td> <td>1.0</td> <td>3.0</td> <td>1.2</td> </tr> <tr> <td>0805</td> <td>1.2</td> <td>4.0</td> <td>1.65</td> </tr> </tbody> </table> 	类型 Type	a	b	c	0201	0.25	0.3	0.3	0402	0.4	1.5	0.5	0603	1.0	3.0	1.2	0805	1.2	4.0	1.65
尺寸 Size	弯曲变形量 Flexure	施压速度 Pressurizing Speed	保持时间 Duration																														
0201,	1mm	<0.5mm/s	10±1s																														
0402, 0603, 0805	2mm																																
类型 Type	a	b	c																														
0201	0.25	0.3	0.3																														
0402	0.4	1.5	0.5																														
0603	1.0	3.0	1.2																														
0805	1.2	4.0	1.65																														

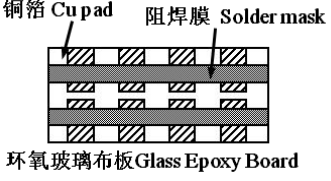
<p>振动 Vibration</p>	<p>IEC 60068-2-80</p>	<p>① 将晶片焊接在测试基板上（如右图所示的环氧玻璃布板）； Solder the chip to the testing jig (glass epoxy board shown in the left) using eutectic solder.</p> <p>② 晶片以全振幅为 1.5mm 进行振动，频率范围为 10Hz ~55 Hz； The chip shall be subjected to a simple harmonic motion having total amplitude of 1.5mm, the frequency being varied uniformly between the approximate limits of 10 and 55 Hz.</p> <p>③ 振动频率按 10Hz→55Hz→10Hz 循环，周期为 1 分钟，在空间三个互相垂直的方向上各振动 2 小时（共 6 小时）。 The frequency ranges from 10 to 55 Hz and return to 10 Hz shall be traversed in approximately 1 minute. This motion shall be applied for a period of 2 hours in each 3 mutually perpendicular directions (total of 6 hours).</p>	<p>无外观损伤。 No visible damage.</p> 															
<p>坠落 Dropping</p>	<p>IEC 60068-2-32</p>	<p>从 1m 的高度让晶片自由坠落至水泥地面 10 次。 Drop a chip 10 times on a concrete floor from a height of 1 meter.</p>	<p>无外观损伤。 No visible damage.</p>															
<p>可焊性 Solderability</p>	<p>IEC 60068-2-58</p>	<p>① 焊接温度 Solder temperature: 245±5℃. ② 浸渍时间 Duration: 3±0.3s. ③ 焊锡成分 Solder: Sn/3.0Ag/0.5Cu. ④ 助焊剂 Flux: （重量比）25%松香和 75%酒精 25% Resin and 75% ethanol in weight.</p>	<p>① 无外观损伤； No visible damage. ② 元件端电极的焊锡覆盖率不小于 95%。 Wetting shall exceed 95% coverage.</p>															
<p>耐焊性 Resistance to Soldering Heat</p>	<p>IEC 60068-2-58</p>	<p>① 焊接温度 Solder temperature: 260±5℃. ② 浸渍时间 Duration: 10±1s. ③ 焊锡成分 Solder: Sn/3.0Ag/0.5Cu. ④ 助焊剂 Flux: （重量比）25%松香和 75%酒精 25% Resin and 75% ethanol in weight. ⑤ 试验后标准条件下放置 1~2 小时后测量。 The chip shall be stabilized at normal condition for 1~2 hours before measuring.</p>	<p>① 无外观损伤； No visible damage. ② $\Delta R_{25}/R_{25} \leq 5\%$ ③ $\Delta B/B \leq 2\%$</p>															
<p>温度周期 Temperature cycling</p>	<p>IEC 60068-2-14</p>	<p>① 无负载于下表所示的环境条件下重复 5 次。 5 cycles of following sequence without loading.</p> <table border="1" data-bbox="491 1429 1040 1624"> <thead> <tr> <th>步骤 Step</th> <th>温度 Temperature</th> <th>时间 Time</th> </tr> </thead> <tbody> <tr> <td>1</td> <td>-40±5℃</td> <td>30±3min</td> </tr> <tr> <td>2</td> <td>25±2℃</td> <td>5±3min</td> </tr> <tr> <td>3</td> <td>125±2℃</td> <td>30±3min</td> </tr> <tr> <td>4</td> <td>25±2℃</td> <td>5±3min</td> </tr> </tbody> </table> <p>② 试验后标准条件下放置 1~2 小时后测量。 The chip shall be stabilized at normal condition for 1~2 hours before measuring.</p>	步骤 Step	温度 Temperature	时间 Time	1	-40±5℃	30±3min	2	25±2℃	5±3min	3	125±2℃	30±3min	4	25±2℃	5±3min	<p>① 无外观损伤； No visible damage. ② $\Delta R_{25}/R_{25} \leq 3\%$ ③ $\Delta B/B \leq 2\%$</p>
步骤 Step	温度 Temperature	时间 Time																
1	-40±5℃	30±3min																
2	25±2℃	5±3min																
3	125±2℃	30±3min																
4	25±2℃	5±3min																
<p>高温存放 Resistance to dry heat</p>	<p>IEC 60068-2-2</p>	<p>① 在 125±5℃ 空气中，无负载放置 1000±24 小时。 125±5℃ in air, for 1000±24 hours without loading. ② 试验后标准条件下放置 1~2 小时后测量。 The chip shall be stabilized at normal condition for 1~2 hours before measuring.</p>	<p>① 无外观损伤； No visible damage. ② $\Delta R_{25}/R_{25} \leq 5\%$ ③ $\Delta B/B \leq 2\%$</p>															

低温存放 Resistance to cold	IEC 60068-2-1	① 在-40±3℃空气中，无负载放置 1000±24 小时。 -40±3℃ in air, for 1000±24 hours without loading. ② 试验后标准条件下放置 1~2 小时后测量。 The chip shall be stabilized at normal condition for 1~2 hours before measuring.	① 无外观损伤； No visible damage. ② $ \Delta R25/R25 \leq 5\%$ ③ $ \Delta B/B \leq 2\%$
湿热存放 Resistance to damp heat	IEC 60068-2-78	① 在 40±2℃，相对湿度 90~95%空气中，无负载放置 1000±24 小时。 40±2℃, 90~95%RH in air, for 1000±24 hours without loading. ② 试验后标准条件下放置 1~2 小时后测量。 The chip shall be stabilized at normal condition for 1~2 hours before measuring.	① 无外观损伤； No visible damage. ② $ \Delta R25/R25 \leq 3\%$ ③ $ \Delta B/B \leq 2\%$
高温负荷 Resistance to high temperature load	IEC 60539-1 5.25.4	① 在 85±2℃空气中，施加允许工作电流 1000±48 小时。 85±2℃ in air with permissive operating current for 1000±48 hours ② 试验后标准条件下放置 1~2 小时后测量。 The chip shall be stabilized at normal condition for 1~2 hours before measuring.	① 无外观损伤； No visible damage. ② $ \Delta R25/R25 \leq 5\%$ ③ $ \Delta B/B \leq 2\%$

编带 Taping

类型 Type	0201	0402	0603	0805
编带厚度 Tape thickness(mm)	0.5±0.15	0.5±0.15	0.8±0.15	0.85±0.2
编带材质 Tape material	纸带 Paper Tape			
每盘数量 Quantity per Reel	15K	10K	4K	4K

(1) 编带图 Taping Drawings

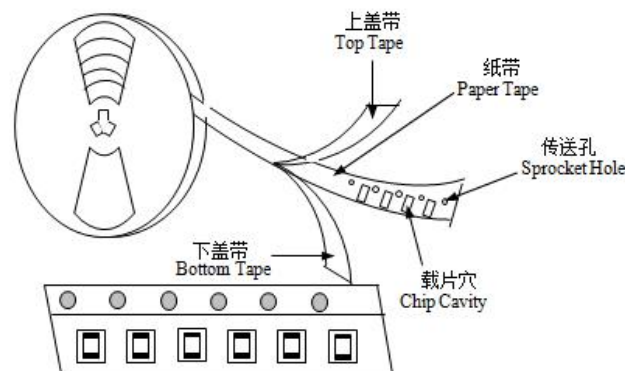

(2) 纸带尺寸 Paper Tape Dimensions

(单位 Unit: mm)

0201 系列

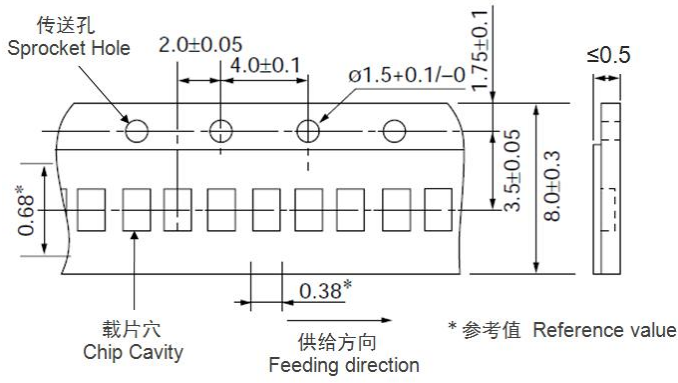

0402 系列

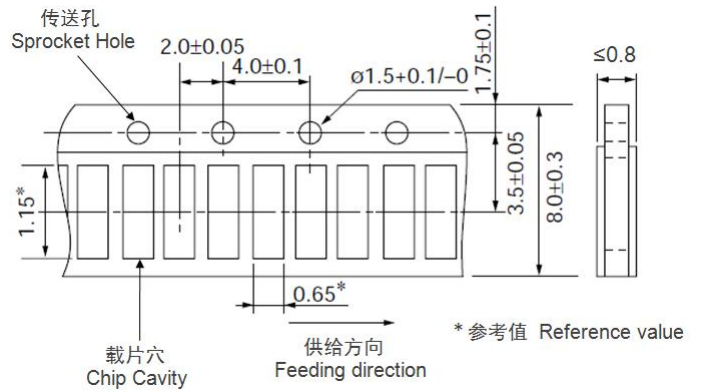

0603 系列

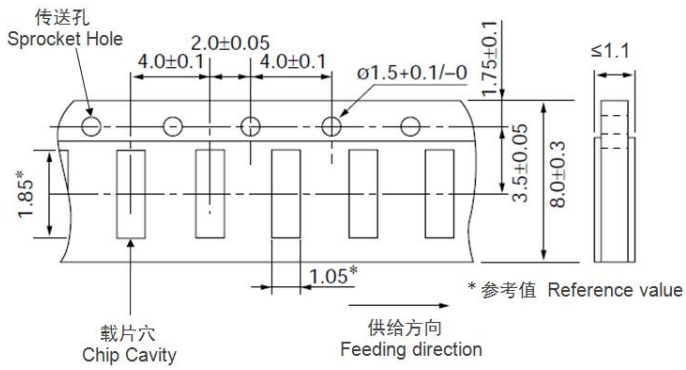

0805 系列

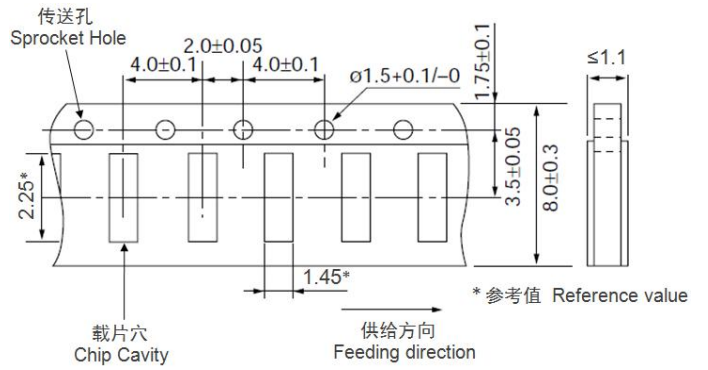

(3) 卷盘尺寸 Reel Dimensions (单位 Unit: mm)

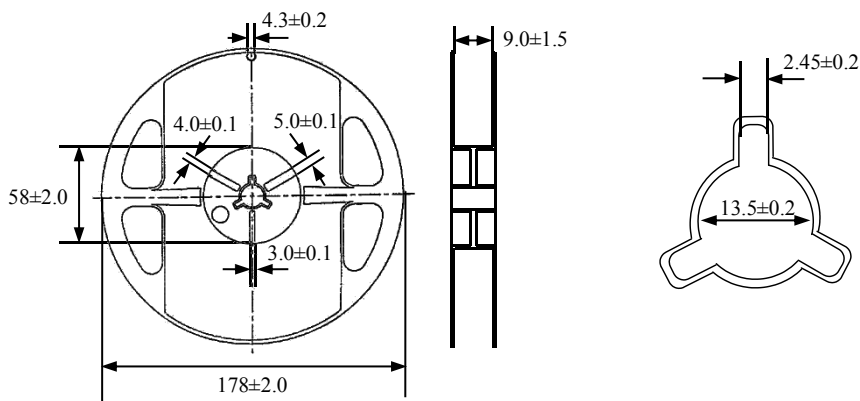

储存

- **储存条件**
 - a. 储存温度: $-10^{\circ}\text{C} \sim 40^{\circ}\text{C}$
 - b. 相对湿度: $\leq 75\% \text{RH}$
 - c. 避免接触粉尘、腐蚀性气氛和阳光
- **储存期限: 产品交付后 6 个月**

注意事项

- 热敏电阻不可在以下条件下工作或储存:
 - (1) 腐蚀性气体或还原性气体
(氯气、硫化氢气体、氨气、硫酸气体、一氧化氮等)。
 - (2) 挥发性或易燃性气体
 - (3) 多尘条件
 - (4) 高压或低压条件
 - (5) 潮湿场所
 - (6) 存在盐水、油、化学液体或有机溶剂的场所
 - (7) 强烈振动
 - (8) 存在类似有害条件的其他场所
- 热敏电阻的陶瓷属于易碎材料，使用时不可施加过大压力或冲击。
- 热敏电阻不可在超过目录规定的温度范围情况下工作。

Storage

- **Storage Conditions**
 - a. Storage Temperature: $-10^{\circ}\text{C} \sim 40^{\circ}\text{C}$
 - b. Relative Humidity: $\cong 75\% \text{RH}$
 - c. Keep away from corrosive atmosphere and sunlight.
- **Period of Storage: 6 Months after delivery**

Notes & Warnings

- The thermistors shall not be operated and stored under the following environmental condition:
 - (1) Corrosive or deoxidized atmospheres
(such as chlorine, sulfurated hydrogen, ammonia, sulfuric acid, nitric oxide and so on)
 - (2) Volatile or inflammable atmospheres
 - (3) Dusty condition
 - (4) Excessively high or low pressure condition
 - (5) Humid site
 - (6) Places with brine, oil, chemical liquid or organic solvent
 - (7) Intense vibration
 - (8) Places with analogously deleterious conditions
- The ceramic body of the thermistors is fragile, no excessive pressure or impact shall be exerted on it.
- The thermistors shall not be operated beyond the specified "Operating Temperature Range" in the catalog.

建议焊接条件

• **回流焊**

- 温升 1~2°C/sec.
- 预热：150~170°C/90±30 sec.
- 大于 240°C时间：20~40sec
- 峰值温度：最高 260°C/10 sec.
- 焊锡：96.5Sn/3.0Ag/0.5Cu
- 回流焊：最多 2 次

10 Recommended Soldering Technologies

• **Re-flowing Profile**

- 1~2°C/sec. Ramp
- Pre-heating: 150~170°C/90±30 sec.
- Time above 240°C: 20~40 sec.
- Peak temperature: 260°C Max./10 sec.
- Solder paste: 96.5Sn/3.0Ag/0.5Cu
- Max.2 times for re-flowing

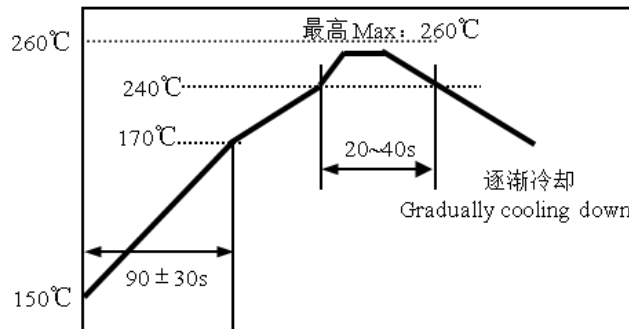

• **手工焊**

- 烙铁功率：最大 20W
- 预热：150°C/60sec.
- 烙铁头温度：最高 280°C
- 焊接时间：最多 3sec.
- 焊锡：96.5Sn/3.0Ag/0.5Cu
- 手工焊：最多 1 次

• **Iron Soldering Profile**

- Iron soldering power: Max.20W
- Pre-heating: 150°C/60sec.
- Soldering Tip temperature: 280°C Max.
- Soldering time: 3 sec Max.
- Solder paste: 96.5Sn/3.0Ag/0.5Cu
- Max.1 times for iron soldering

[注：不要使烙铁头接触到端头]

[Note: Take care not to apply the tip of the soldering iron to the terminal electrodes.]

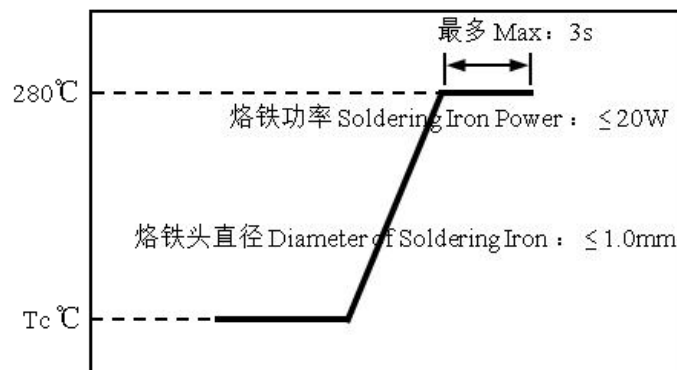

R-T 表 R-T table

温度 Temp. (°C)	R 最小值 R_Min (Kohm)	R 中心值 R_Cent (Kohm)	R 最大值 R_Max (Kohm)	阻值公差 Res TOL.	温度公差 Temp. TOL.(°C)
-40	949.791	1,035.824	1,126.827	8.79%	1.26
-39	888.540	968.373	1,052.740	8.71%	1.26
-38	831.658	905.774	984.030	8.64%	1.26
-37	778.804	847.648	920.271	8.57%	1.26
-36	729.668	793.646	861.075	8.50%	1.26
-35	683.964	743.448	806.086	8.43%	1.26
-34	641.429	696.763	754.977	8.35%	1.26
-33	601.825	653.321	707.450	8.29%	1.26
-32	564.929	612.877	663.231	8.22%	1.26
-31	530.540	575.204	622.069	8.15%	1.25
-30	498.472	540.096	583.732	8.08%	1.25
-29	468.553	507.361	548.010	8.01%	1.25
-28	440.625	476.824	514.707	7.94%	1.25
-27	414.544	448.324	483.644	7.88%	1.25
-26	390.176	421.712	454.658	7.81%	1.25
-25	367.398	396.852	427.595	7.75%	1.25
-24	346.050	373.567	402.263	7.68%	1.25
-23	326.081	351.799	378.595	7.62%	1.25
-22	307.394	331.439	356.473	7.55%	1.24
-21	289.897	312.389	335.785	7.49%	1.24
-20	273.509	294.556	316.430	7.43%	1.24
-19	258.151	277.855	298.314	7.36%	1.24
-18	243.754	262.206	281.350	7.30%	1.24
-17	230.250	247.538	265.458	7.24%	1.24
-16	217.579	233.782	250.563	7.18%	1.24
-15	205.686	220.877	236.598	7.12%	1.23
-14	194.516	208.765	223.497	7.06%	1.23
-13	184.023	197.392	211.204	7.00%	1.23
-12	174.160	186.710	199.662	6.94%	1.23
-11	164.887	176.671	188.823	6.88%	1.23
-10	156.165	167.233	178.638	6.82%	1.23
-9	147.957	158.357	169.065	6.76%	1.22
-8	140.231	150.007	160.063	6.70%	1.22
-7	132.955	142.147	151.594	6.65%	1.22
-6	126.101	134.747	143.625	6.59%	1.22
-5	119.641	127.776	136.123	6.53%	1.22
-4	113.542	121.199	129.048	6.48%	1.21
-3	107.791	115.000	122.383	6.42%	1.21
-2	102.367	109.155	116.103	6.36%	1.21
-1	97.247	103.643	110.182	6.31%	1.21
0	92.415	98.442	104.599	6.26%	1.21
1	87.856	93.538	99.338	6.20%	1.20

温度 Temp. (°C)	R 最小值 R_Min (Kohm)	R 中心值 R_Cent (Kohm)	R 最大值 R_Max (Kohm)	阻值公差 Res TOL.	温度公差 Temp. TOL.(°C)
2	83.549	88.907	94.372	6.15%	1.20
3	79.478	84.533	89.684	6.09%	1.20
4	75.629	80.399	85.255	6.04%	1.20
5	71.989	76.491	81.070	5.99%	1.19
6	68.539	72.788	77.108	5.93%	1.19
7	65.274	69.287	73.363	5.88%	1.19
8	62.184	65.975	69.821	5.83%	1.19
9	59.258	62.840	66.472	5.78%	1.18
10	56.487	59.873	63.302	5.73%	1.18
11	53.864	57.065	60.304	5.68%	1.18
12	51.377	54.404	57.466	5.63%	1.18
13	49.020	51.883	54.776	5.58%	1.17
14	46.783	49.493	52.228	5.53%	1.17
15	44.662	47.226	49.813	5.48%	1.17
16	42.647	45.075	47.522	5.43%	1.16
17	40.735	43.034	45.349	5.38%	1.16
18	38.920	41.097	43.288	5.33%	1.16
19	37.195	39.259	41.332	5.28%	1.15
20	35.557	37.512	39.476	5.23%	1.15
21	34.000	35.853	37.713	5.19%	1.15
22	32.520	34.277	36.039	5.14%	1.15
23	31.113	32.779	34.449	5.09%	1.14
24	29.774	31.355	32.937	5.05%	1.14
25	28.500	30.000	31.500	5.00%	1.14
26	27.264	28.711	30.160	5.05%	1.15
27	26.088	27.485	28.885	5.09%	1.17
28	24.969	26.318	27.670	5.14%	1.19
29	23.904	25.206	26.513	5.18%	1.21
30	22.891	24.148	25.410	5.23%	1.22
31	21.926	23.140	24.360	5.27%	1.24
32	21.007	22.180	23.359	5.32%	1.26
33	20.132	21.264	22.405	5.36%	1.28
34	19.298	20.392	21.494	5.41%	1.30
35	18.502	19.560	20.626	5.45%	1.32
36	17.744	18.766	19.797	5.49%	1.34
37	17.021	18.009	19.006	5.54%	1.35
38	16.332	17.286	18.251	5.58%	1.37
39	15.674	16.597	17.530	5.62%	1.39
40	15.046	15.938	16.841	5.67%	1.41
41	14.446	15.309	16.183	5.71%	1.43
42	13.874	14.708	15.554	5.75%	1.45
43	13.327	14.134	14.953	5.79%	1.47
44	12.805	13.586	14.378	5.84%	1.49
45	12.305	13.061	13.829	5.88%	1.51

温度 Temp. (°C)	R 最小值 R_Min (Kohm)	R 中心值 R_Cent (Kohm)	R 最大值 R_Max (Kohm)	阻值公差 Res TOL.	温度公差 Temp. TOL.(°C)
46	11.829	12.560	13.304	5.92%	1.53
47	11.373	12.081	12.801	5.96%	1.55
48	10.937	11.623	12.320	6.00%	1.57
49	10.521	11.184	11.860	6.04%	1.59
50	10.122	10.765	11.419	6.08%	1.61
51	9.741	10.363	10.997	6.12%	1.63
52	9.375	9.978	10.593	6.16%	1.65
53	9.026	9.610	10.206	6.20%	1.67
54	8.691	9.257	9.835	6.24%	1.69
55	8.371	8.919	9.479	6.28%	1.71
56	8.063	8.595	9.138	6.32%	1.73
57	7.769	8.284	8.811	6.36%	1.75
58	7.487	7.986	8.497	6.40%	1.77
59	7.217	7.701	8.196	6.44%	1.79
60	6.957	7.427	7.908	6.48%	1.81
61	6.709	7.164	7.631	6.51%	1.84
62	6.471	6.913	7.365	6.55%	1.86
63	6.243	6.671	7.111	6.59%	1.88
64	6.024	6.439	6.866	6.63%	1.90
65	5.813	6.216	6.631	6.67%	1.92
66	5.611	6.002	6.404	6.70%	1.94
67	5.417	5.796	6.187	6.74%	1.96
68	5.230	5.598	5.978	6.78%	1.99
69	5.051	5.408	5.777	6.81%	2.01
70	4.878	5.226	5.584	6.85%	2.03
71	4.714	5.051	5.399	6.89%	2.05
72	4.555	4.883	5.221	6.92%	2.08
73	4.403	4.721	5.050	6.96%	2.10
74	4.257	4.566	4.885	7.00%	2.12
75	4.116	4.416	4.727	7.03%	2.14
76	3.980	4.272	4.574	7.07%	2.17
77	3.849	4.133	4.427	7.10%	2.19
78	3.724	4.000	4.285	7.14%	2.21
79	3.603	3.871	4.148	7.17%	2.23
80	3.486	3.747	4.017	7.21%	2.26
81	3.375	3.628	3.891	7.24%	2.28
82	3.267	3.513	3.769	7.28%	2.30
83	3.163	3.403	3.652	7.31%	2.33
84	3.063	3.296	3.539	7.34%	2.35
85	2.967	3.194	3.429	7.38%	2.37
86	2.874	3.095	3.324	7.41%	2.40
87	2.785	3.000	3.223	7.45%	2.42
88	2.698	2.908	3.125	7.48%	2.45
89	2.615	2.819	3.031	7.51%	2.47

温度 Temp. (°C)	R 最小值 R_Min (Kohm)	R 中心值 R_Cent (Kohm)	R 最大值 R_Max (Kohm)	阻值公差 Res TOL.	温度公差 Temp. TOL.(°C)
90	2.535	2.733	2.940	7.55%	2.49
91	2.458	2.651	2.852	7.58%	2.52
92	2.383	2.571	2.767	7.61%	2.54
93	2.311	2.494	2.685	7.64%	2.57
94	2.242	2.420	2.606	7.68%	2.59
95	2.175	2.348	2.529	7.71%	2.62
96	2.110	2.279	2.456	7.74%	2.64
97	2.048	2.213	2.385	7.77%	2.67
98	1.988	2.149	2.316	7.81%	2.69
99	1.930	2.086	2.250	7.84%	2.72
100	1.874	2.026	2.186	7.87%	2.74
101	1.820	1.968	2.124	7.90%	2.77
102	1.767	1.912	2.064	7.93%	2.79
103	1.717	1.858	2.006	7.96%	2.82
104	1.668	1.806	1.950	7.99%	2.84
105	1.621	1.755	1.896	8.02%	2.87
106	1.575	1.706	1.843	8.05%	2.89
107	1.531	1.658	1.793	8.08%	2.92
108	1.488	1.613	1.743	8.11%	2.95
109	1.446	1.568	1.696	8.15%	2.97
110	1.406	1.525	1.650	8.18%	3.00
111	1.368	1.484	1.605	8.21%	3.02
112	1.330	1.443	1.562	8.23%	3.05
113	1.294	1.404	1.520	8.26%	3.08
114	1.259	1.367	1.480	8.29%	3.10
115	1.225	1.330	1.441	8.32%	3.13
116	1.192	1.295	1.403	8.35%	3.16
117	1.160	1.261	1.366	8.38%	3.18
118	1.129	1.228	1.331	8.41%	3.21
119	1.100	1.196	1.296	8.44%	3.24
120	1.071	1.164	1.263	8.47%	3.26
121	1.043	1.134	1.231	8.50%	3.29
122	1.016	1.105	1.199	8.52%	3.32
123	0.989	1.077	1.169	8.55%	3.35
124	0.964	1.049	1.139	8.58%	3.37
125	0.939	1.023	1.111	8.61%	3.40

单击下面可查看定价，库存，交付和生命周期等信息

[>>KUU\(永裕泰\)](#)