

TRANSIENT VOLTAGE SUPPRESSOR

FEATURE

- ✧ Plastic package.
- ✧ Glass passivated chip junction in SMA Package
- ✧ Excellent clamping capability.
- ✧ Low zener impedance.
- ✧ 400W peak pulse power capability on 10/1000 μ s waveform.
- ✧ Typical IR less than 1 μ A above 13V.
- ✧ Fast response time: typically less than 1.0ps from 0 Volts to BV min.
- ✧ High temperature soldering guaranteed: 265 $^{\circ}$ C/10 seconds

MECHANICAL DATE

- ✧ Case: JEDEC SMA Molded Plastic.
- ✧ Terminals: Axial leads, solderable per MIL-STD-750, Method 2026.
- ✧ Polarity: Color band denoted cathode except bidirectional.
- ✧ Mounting Position: Any.

MAXIMUM RATINGS AND CHARACTERISTICS

Ratings at 25 $^{\circ}$ C ambient temperature unless otherwise specified.

Peak Pulse Power Dissipation on 10/1000 μ s waveform (Note1, Fig.1).	P _{PPM}	Minimum 400	Watts
Peak Pulse Current of on 10/1000 μ s waveform. (Note1, Fig.3)	I _{PPM}	See Table	Amps
Steady State Power Dissipation at TL =75 $^{\circ}$ C, Lead lengths. 375", (9.5mm) (Fig.5).	P _{M(AV)}	3.3	Watts
Peak Forward Surge Current, 8.3ms Single Half Sine-Wave Superimposed on Rated Load, (JEDEC Method) (Note 2, Fig.6).	I _{FPSM}	40	Amps
Operating junction and Storage Temperature Range.	T _J , T _{STG}	-55 to +150	$^{\circ}$ C

Notes:

1. Non-repetitive current pulse, per Fig. 3 and derated above TA = 25 $^{\circ}$ C per Fig. 2.
2. 8.3ms single half sine-wave, or equivalent square wave, Duty cycle = 4 pulses per minutes maximum.

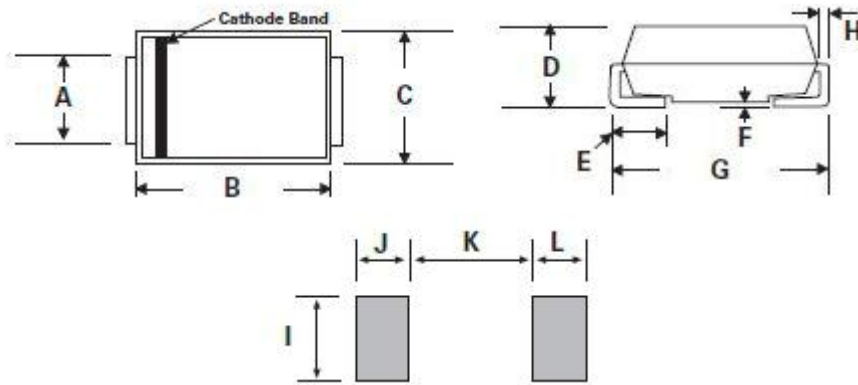

A	1.25	1.65	0.049	0.065
B	3.99	4.5	0.157	0.177
C	2.54	2.79	0.1	0.11
D	1.98	2.29	0.078	0.09
E	0.78	1.52	0.03	0.06
F	-	0.203	-	0.008
G	4.93	5.28	0.194	0.208
H	0.152	0.305	0.006	0.012
I	1.8	-	0.07	-
J	2.1	-	0.082	-
K	-	2.3	-	0.09
L	2.1	-	0.082	-

ELECTRICAL CHARACTERISTICS

Part Number		Marking		Reverse Stand-Off Voltage	Breakdown Voltage NIN.@IT	Breakdown Voltage VBH.@IT	Reverse Leakage @VRWM	Test Current	Peak Pulse Current	Maximum Clamping Voltage @IPP
UNT	BI	UNT	BI	VR(V)	VBL(V)	VBH(V)	IR(uA)	IT(mA)	IPP(A)	VCH(V)
SMAJ5.0A	SMAJ5.0CA	AE	WE	5.0	6.40	7.00	800	10	43.5	9.2
SMAJ6.0A	SMAJ6.0CA	AG	WG	6.0	6.67	7.37	800	10	38.8	10.3
SMAJ6.5A	SMAJ6.5CA	AK	WK	6.5	7.22	7.98	500	10	35.7	11.2
SMAJ7.0A	SMAJ7.0CA	AM	WM	7.0	7.78	8.60	200	10	33.3	12.0
SMAJ7.5A	SMAJ7.5CA	AP	WP	7.5	8.33	9.21	100	1	31.0	12.9
SMAJ8.0A	SMAJ8.0CA	AR	WR	8.0	8.89	9.83	50	1	29.4	13.6
SMAJ8.5A	SMAJ8.5CA	AT	WT	8.5	9.44	10.40	20	1	27.8	14.4
SMAJ9.0A	SMAJ9.0CA	AV	WV	9.0	10.00	11.10	10	1	26.0	15.4
SMAJ10A	SMAJ10CA	AX	WX	10	11.10	12.30	5	1	23.5	17.0
SMAJ11A	SMAJ11CA	AZ	WZ	11	12.20	13.50	1	1	22.0	18.2
SMAJ12A	SMAJ12CA	BE	XE	12	13.30	14.70	1	1	20.1	19.9
SMAJ13A	SMAJ13CA	BG	XG	13	14.40	15.90	1	1	18.6	21.5

Part Number		Marking		Reverse Stand-Off Voltage	Breakdown Voltage NIN.@IT	Breakdown Voltage MAX.@IT	Reverse Leakage @VRWM	Test Current	Peak Pulse Current	Maximum Clamping Voltage @IPP
UNT	BI	UNT	BI	VR(V)	VBL(V)	VBH(V)	IR(μA)	IT(mA)	IPP(A)	VCH(V)
SMAJ14A	SMAJ14CA	BK	XK	14	15.60	17.20	1	1	17.2	23.2
SMAJ15A	SMAJ15CA	BM	XM	15	16.70	18.50	1	1	16.4	24.4
SMAJ16A	SMAJ16CA	BP	XP	16	17.80	19.70	1	1	15.4	26.0
SMAJ17A	SMAJ17CA	BR	XR	17	18.90	20.90	1	1	14.5	27.6
SMAJ18A	SMAJ18CA	BT	XT	18	20.00	22.10	1	1	13.7	29.2
SMAJ20A	SMAJ20CA	BV	XV	20	22.20	24.50	1	1	12.3	32.4
SMAJ22A	SMAJ22CA	BX	XX	22	24.40	26.90	1	1	11.3	35.5
SMAJ24A	SMAJ24CA	BZ	XZ	24	26.70	29.50	1	1	10.3	38.9
SMAJ26A	SMAJ26CA	CE	YE	26	28.90	31.90	1	1	9.5	42.1
SMAJ28A	SMAJ28CA	CG	YG	28	31.10	34.40	1	1	8.8	45.4
SMAJ30A	SMAJ30CA	CK	YK	30	33.30	36.80	1	1	8.3	48.4
SMAJ33A	SMAJ33CA	CM	YM	33	40.00	44.20	1	1	6.9	58.1
SMAJ36A	SMAJ36CA	CP	YP	36	36.70	40.60	1	1	7.5	53.3
SMAJ40A	SMAJ40CA	CR	YR	40	44.40	49.10	1	1	6.2	64.5
SMAJ43A	SMAJ43CA	CT	YT	43	47.80	52.80	1	1	5.8	69.4
SMAJ45A	SMAJ45CA	CV	YV	45	50.00	55.30	1	1	5.5	72.7
SMAJ48A	SMAJ48CA	CX	YX	48	53.30	58.90	1	1	5.2	77.4
SMAJ51A	SMAJ51CA	CZ	YZ	51	56.70	62.70	1	1	4.9	82.4
SMAJ54A	SMAJ54CA	RE	ZE	54	60.00	66.30	1	1	4.6	87.1
SMAJ58A	SMAJ58CA	RG	ZG	58	64.40	71.20	1	1	4.3	93.6
SMAJ60A	SMAJ60CA	RK	ZK	60	66.70	73.70	1	1	4.1	96.8
SMAJ64A	SMAJ64CA	RM	ZM	64	71.10	78.60	1	1	3.9	103
SMAJ70A	SMAJ70CA	RP	ZP	70	77.80	86.00	1	1	3.5	113
SMAJ75A	SMAJ75CA	RR	ZR	75	83.30	92.10	1	1	3.3	121
SMAJ78A	SMAJ78CA	RT	ZT	78	86.70	95.80	1	1	3.2	126
SMAJ85A	SMAJ85CA	RV	ZV	85	94.4	104.0	1	1	2.9	137
SMAJ90A	SMAJ90CA	RX	ZX	90	100.0	111.0	1	1	2.7	146
SMAJ100A	SMAJ100CA	RZ	ZZ	100	111.0	123.0	1	1	2.5	162
SMAJ110A	SMAJ110CA	SE	VE	110	122.0	135.0	1	1	2.3	177
SMAJ120A	SMAJ120CA	SG	VG	120	133.0	147.0	1	1	2.1	193
SMAJ130A	SMAJ130CA	SK	VK	130	144.0	159.0	1	1	1.9	209
SMAJ150A	SMAJ150CA	SM	VM	150	167.0	185.0	1	1	1.6	243
SMAJ160A	SMAJ160CA	SP	VP	160	178.0	197.0	1	1	1.5	259
SMAJ170A	SMAJ170CA	SR	VR	170	189.0	209.0	1	1	1.5	275
SMAJ180A	SMAJ180CA	ST	VT	180	201.0	222.0	1	1	1.4	292
SMAJ190A	SMAJ190CA	SU	YU	190	209.0	243.0	1	1	1.3	308
SMAJ200A	SMAJ200CA	SW	YW	200	224.0	247.0	1	1	1.2	324
SMAJ220A	SMAJ220CA	GE	VX	220	246.0	272.0	1	1	1.1	356
SMAJ250A	SMAJ250CA	SZ	VZ	250	279.0	309.0	1	1	1.0	405
SMAJ300A	SMAJ300CA	TE	UE	300	335.0	371.0	1	1	0.8	486
SMAJ350A	SMAJ350CA	TG	UG	350	391.0	432.0	1	1	0.7	567
SMAJ400A	SMAJ400CA	TK	UK	400	447.0	494.0	1	1	0.6	648
SMAJ440A	SMAJ440CA	TM	UM	440	492.0	543.0	1	1	0.6	713

Notes: For bidirectional type having VRWM of 10 volts and less, the IR limit is double.

RATINGS AND CHARACTERISTIC CURVES ($T_A=25^\circ\text{C}$ unless otherwise noted)

Figure 1 - Peak Pulse Power Rating Curve

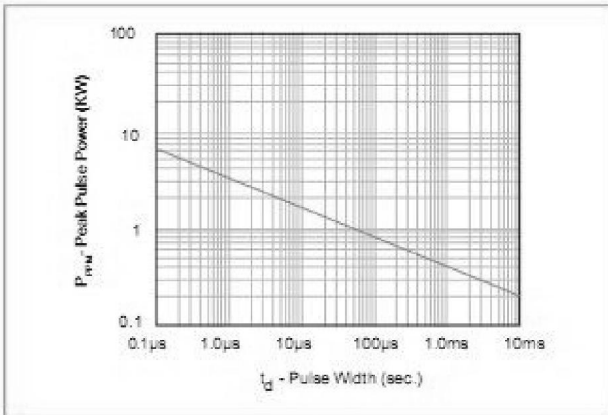

Figure 2 - Pulse Derating Curve

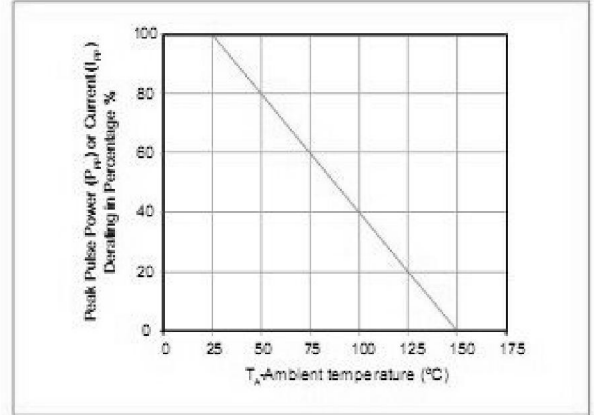

Figure 3 - Pulse Waveform

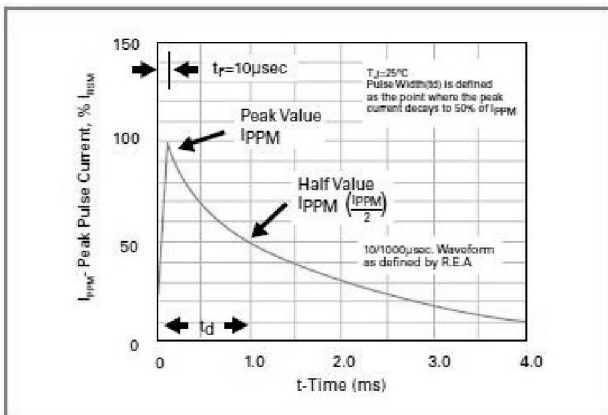

Figure 4 - Typical Junction Capacitance Uni-Directional

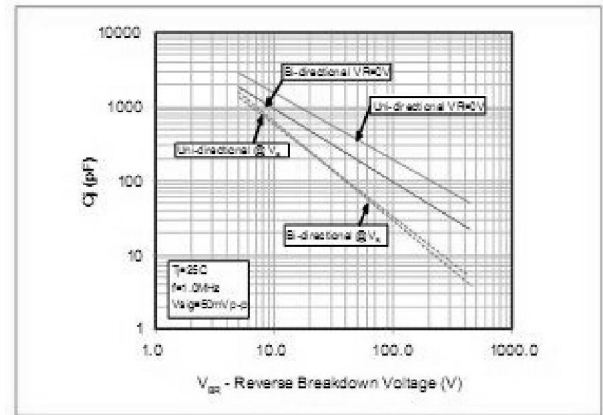

Figure 5 - Steady State Power Dissipation Derating Curve

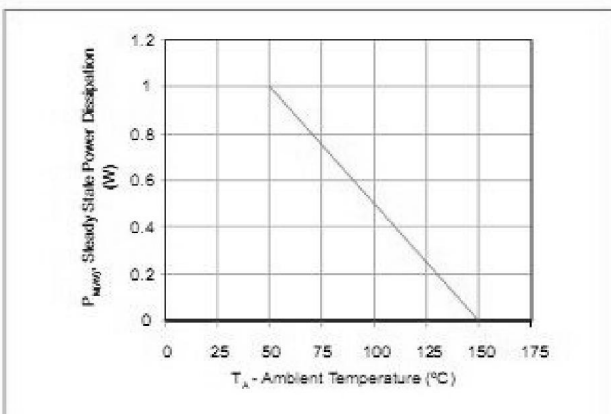
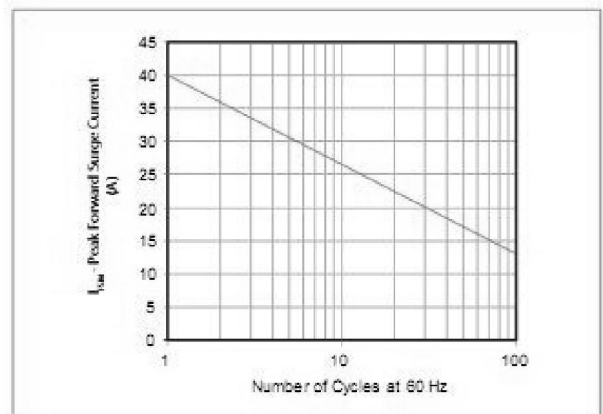

Figure 6 - Maximum Non-Repetitive Forward Surge Current Uni-Directional Only



单击下面可查看定价，库存，交付和生命周期等信息

[>>KUU\(永裕泰\)](#)