

N-Channel Enhancement Mode Power MOSFET

Description

The 15N10 uses advanced trench technology to provide excellent $R_{DS(ON)}$, low gate charge and operation with gate voltages as low as 4.5V. This device is suitable for use as a Battery protection or in other switching application.

TO-252

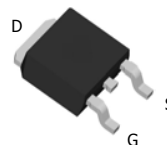

General Features

- High power and current handling capability
- Lead free product is acquired
- Surface mount package

V_{DSS}	$R_{DS(ON)}$ @10V (typ)	I_D
100V	111 m Ω	15A

Application

- Battery switch
- DC/DC converter

Equivalent Circuit

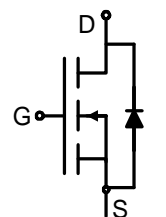

MARKING

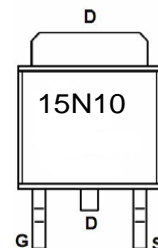

Absolute Maximum Ratings ($T_A=25^\circ\text{C}$ unless otherwise noted)

Parameter	Symbol	Limit	Unit
Drain-Source Voltage	V_{DS}	100	V
Gate-Source Voltage	V_{GS}	± 20	V
Drain Current-Continuous $T_C=25^\circ\text{C}$	I_D	15	A
Drain Current-Continuous $T_C=100^\circ\text{C}$		10.0	A
Drain Current-Pulsed ^(Note 1)	I_{DM}	36	A
Maximum Power Dissipation $T_C=25^\circ\text{C}$	P_D	30	W
Maximum Power Dissipation $T_C=100^\circ\text{C}$		15	W
Operating Junction and Storage Temperature Range	T_J, T_{STG}	-55 To 175	$^\circ\text{C}$

Thermal Characteristic

Thermal Resistance, Junction-to-Case ^(Note 2)	$R_{\theta JC}$	5	$^\circ\text{C/W}$
--	-----------------	---	--------------------

Electrical Characteristics (T_C=25°C unless otherwise noted)

Parameter	Symbol	Condition	Min	Typ	Max	Unit
Off Characteristics						
Drain-Source Breakdown Voltage	BV _{DSS}	V _{GS} =0V I _D =250μA	100	107	-	V
Zero Gate Voltage Drain Current	I _{DSS}	V _{DS} =100V, V _{GS} =0V	-	-	1	μA
Gate-Body Leakage Current	I _{GSS}	V _{GS} =±20V, V _{DS} =0V	-	-	±100	nA
On Characteristics (Note 3)						
Gate Threshold Voltage	V _{GS(th)}	V _{DS} =V _{GS} , I _D =250μA	1.2	1.8	2.5	V
Drain-Source On-State Resistance	R _{DS(ON)}	V _{GS} =10V, I _D =10A	-	0.120	0.131	Ω
Drain-Source On-State Resistance	R _{DS(ON)}	V _{GS} =4.5V, I _D =8A	-	0.130	0.136	Ω
Drain-Source On-State Resistance	R _{DS(ON)}	V _{GS} =2.0V, I _D =5A	-	0.140	0.151	Ω
Forward Transconductance	g _{FS}	V _{DS} =25V, I _D =10A	3.5	-	-	S
Dynamic Characteristics (Note4)						
Input Capacitance	C _{iss}	V _{DS} =25V, V _{GS} =0V, F=1.0MHz	-	690	-	PF
Output Capacitance	C _{oss}		-	120	-	PF
Reverse Transfer Capacitance	C _{rss}		-	90	-	PF
Switching Characteristics (Note 4)						
Turn-on Delay Time	t _{d(on)}	V _{DD} =30V, I _D =2A, R _L =15Ω V _{GS} =10V, R _G =2.5Ω	-	11	-	nS
Turn-on Rise Time	t _r		-	7.4	-	nS
Turn-Off Delay Time	t _{d(off)}		-	35	-	nS
Turn-Off Fall Time	t _f		-	9.1	-	nS
Total Gate Charge	Q _g	V _{DS} =30V, I _D =3A, V _{GS} =10V	-	15.5	-	nC
Gate-Source Charge	Q _{gs}		-	3.2	-	nC
Gate-Drain Charge	Q _{gd}		-	4.7	-	nC
Drain-Source Diode Characteristics						
Diode Forward Voltage (Note 3)	V _{SD}	V _{GS} =0V, I _S =9.6A	-	-	1.2	V
Diode Forward Current (Note 2)	I _S		-	-	12	A
Reverse Recovery Time	t _{rr}	T _J = 25°C, I _F =9.6A	-	21		nS
Reverse Recovery Charge	Q _{rr}	di/dt = 100A/μs (Note3)	-	97		nC
Forward Turn-On Time	t _{on}	Intrinsic turn-on time is negligible (turn-on is dominated by LS+LD)				

Notes:

1. Repetitive Rating: Pulse width limited by maximum junction temperature.
2. Surface Mounted on FR4 Board, t ≤ 10 sec.
3. Pulse Test: Pulse Width ≤ 300μs, Duty Cycle ≤ 2%.
4. Guaranteed by design, not subject to production

Typical Electrical and Thermal Characteristics (Curves)

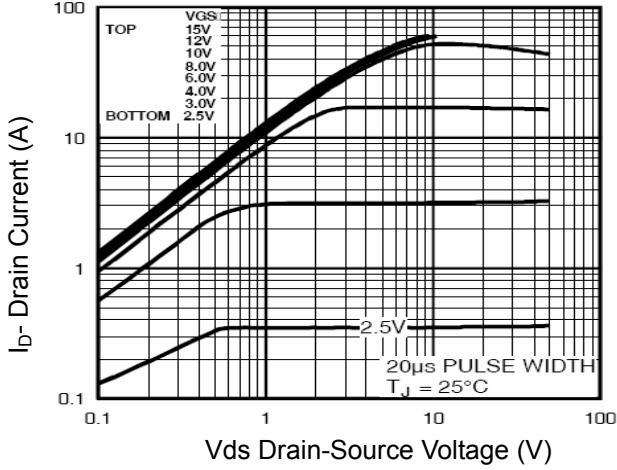

Figure 1 Output Characteristics

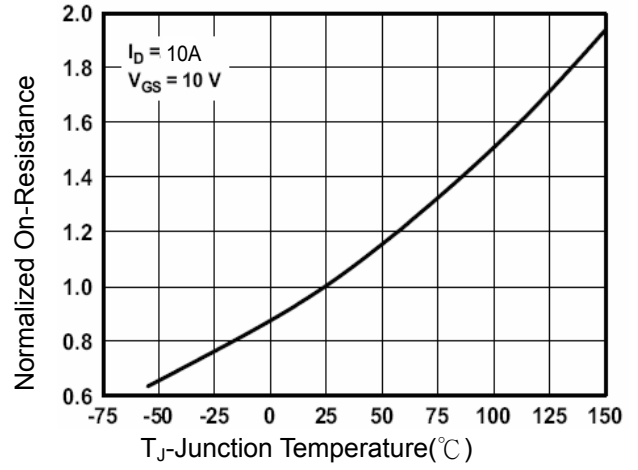

Figure 4 Rdson-Junction Temperature

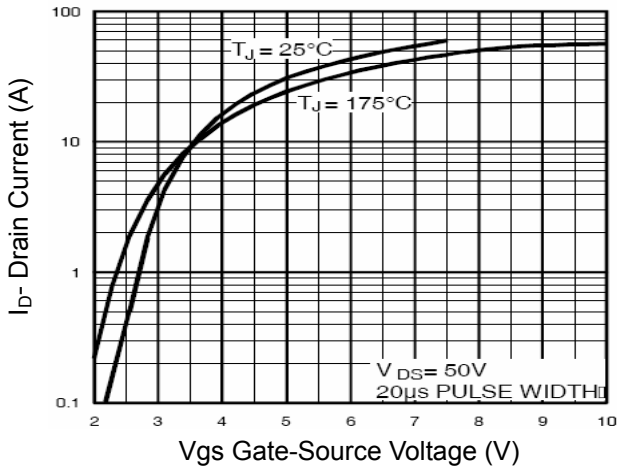

Figure 2 Transfer Characteristics

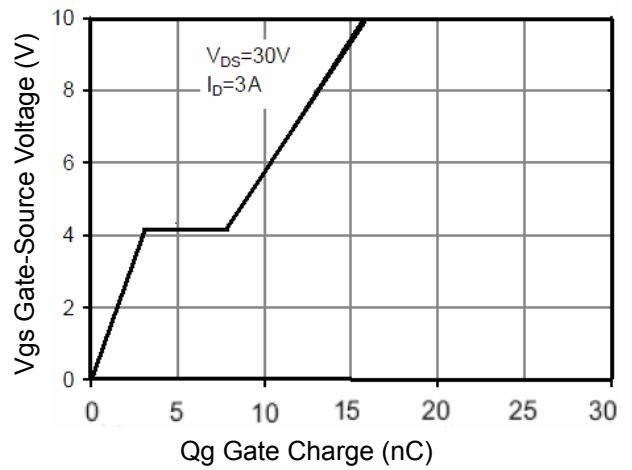

Figure 5 Gate Charge

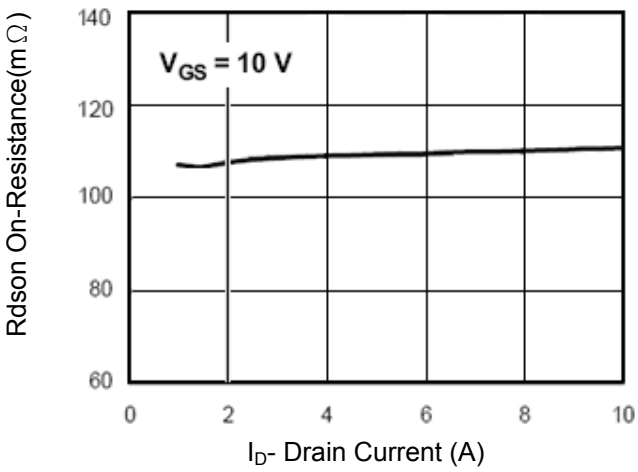

Figure 3 Rdson- Drain Current

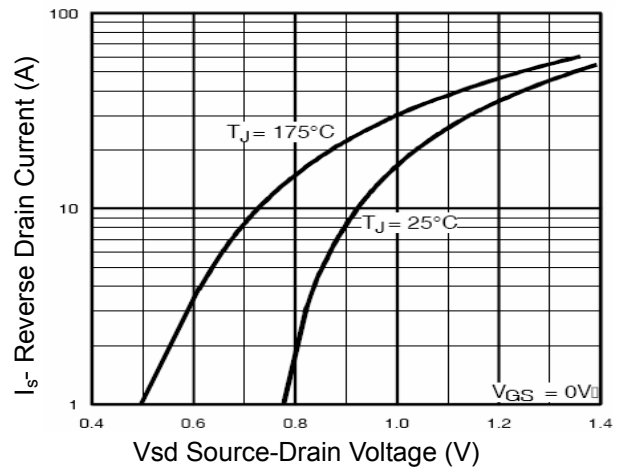

Figure 6 Source- Drain Diode Forward

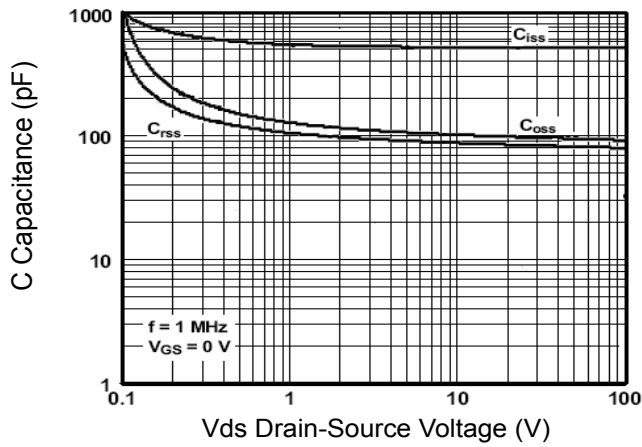

Figure 7 Capacitance vs Vds

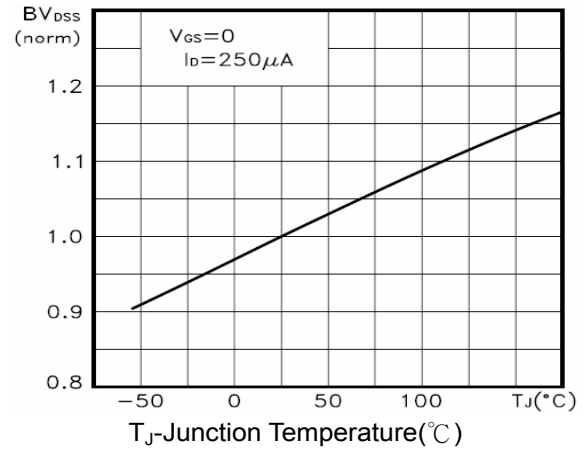

Figure 9 BV_{DSS} vs Junction Temperature

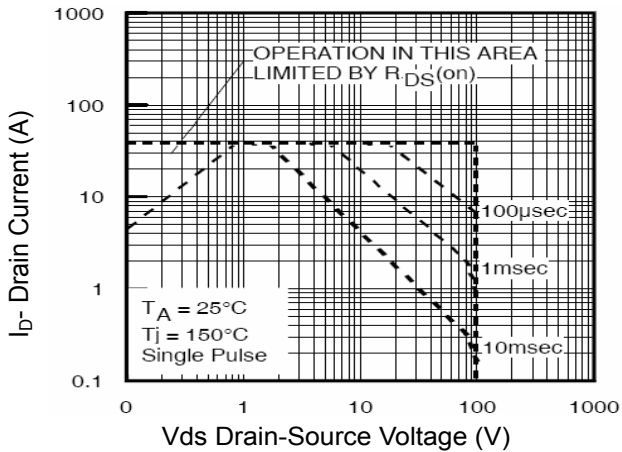

Figure 8 Safe Operation Area

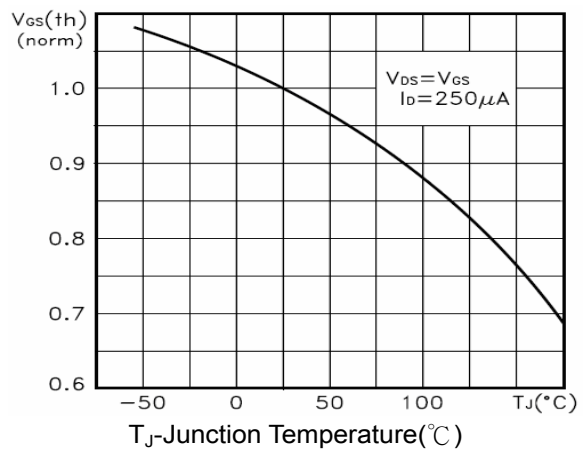

Figure 10 V_{GS(th)} vs Junction Temperature

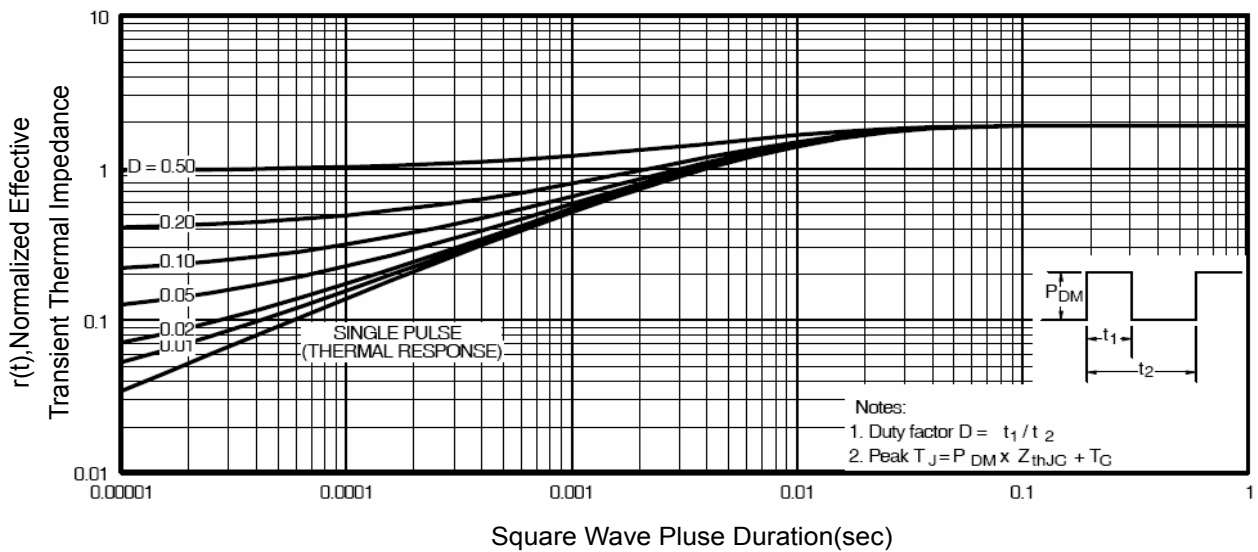
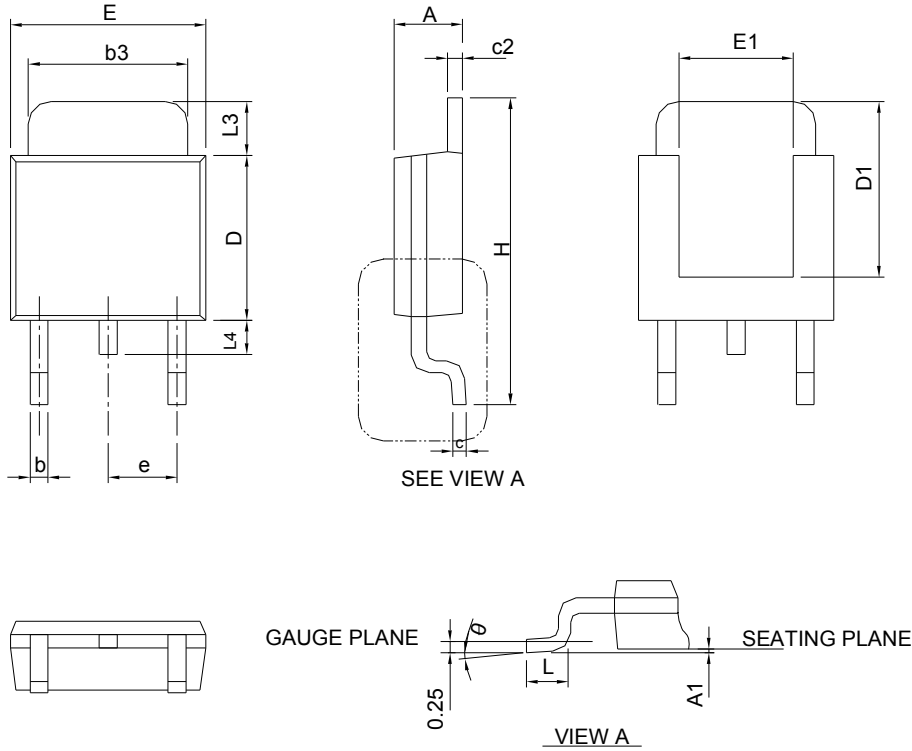

Figure 11 Normalized Maximum Transient Thermal Impedance

Package Information

TO-252



SYMBOL	TO-252-3			
	MILLIMETERS		INCHES	
	MIN.	MAX.	MIN.	MAX.
A	2.18	2.39	0.086	0.094
A1		0.13		0.005
b	0.50	0.89	0.020	0.035
b3	4.95	5.46	0.195	0.215
c	0.46	0.61	0.018	0.024
c2	0.46	0.89	0.018	0.035
D	5.33	6.22	0.210	0.245
D1	4.57	6.00	0.180	0.236
E	6.35	6.73	0.250	0.265
E1	3.81	6.00	0.150	0.236
e	2.29 BSC		0.090 BSC	
H	9.40	10.41	0.370	0.410
L	0.90	1.78	0.035	0.070
L3	0.89	2.03	0.035	0.080
L4		1.02		0.040
θ	0°	8°	0°	8°

RECOMMENDED LAND PATTERN

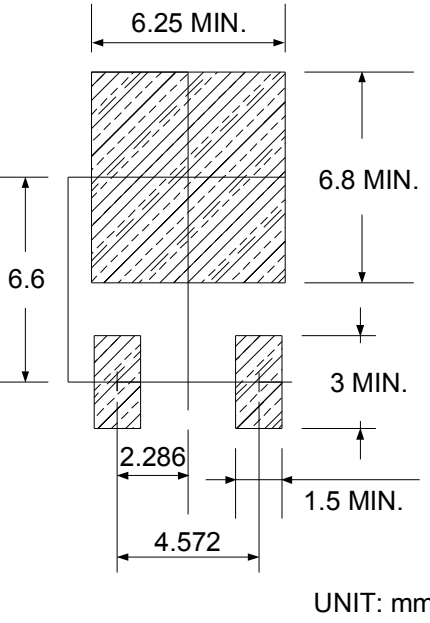

单击下面可查看定价，库存，交付和生命周期等信息

[>>KUU\(永裕泰\)](#)