

P-Channel Enhancement Mode Power MOSFET

Description

The 4409 uses advanced trench technology to provide excellent $R_{DS(ON)}$, low gate charge and operation with gate voltages as low as 4.5V.

General Features

- $V_{DS} = -30V$
 $R_{DS(ON)} < 15m\Omega @ V_{GS}=-4.5V \quad I_D = -12.0A$
 $R_{DS(ON)} < 12m\Omega @ V_{GS}=-10V \quad I_D = -15.0A$
- High power and current handling capability
- Lead free product is acquired
- Surface mount package

Application

- Battery Switch
- Load switch
- Power management

SOP-8

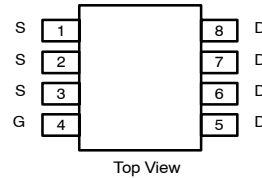

Equivalent Circuit

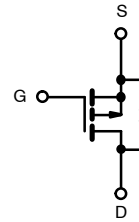

MARKING



Absolute Maximum Ratings ($T_A=25^\circ C$, unless otherwise noted)

Symbol	Parameter	Ratings	Units
V_{DS}	Drain-Source Voltage	-30	V
V_{GS}	Gate-Source Voltage	± 20	V
I_D	Drain Current @ $T_A=25^\circ C$	-15	A
I_{DM}	Drain Current (Pulsed) ^a	-60	A
I_{AR}	Avalanche Current	30	A
E_{AR}	Repetitive Avalanche Energy $L=0.3mH$	135	mJ
P_D	Total Power Dissipation @ $T_A=25^\circ C$	3.1	W
	Total Power Dissipation @ $T_A=75^\circ C$	2.1	
I_S	Maximum Diode Forward Current	-2.1	A
T_j, T_{stg}	Operating Junction and Storage Temperature Range	-55 to +150	$^\circ C$
$R_{\theta JA}$	Thermal Resistance Junction to Ambient (PCB mounted) ^b	40	$^\circ C/W$

a: Repetitive Rating: Pulse width limited by the maximum junction temperature.
 b: 1-in² 2oz Cu PCB board

Electrical Characteristics ($T_A=25^{\circ}\text{C}$, unless otherwise noted)

Symbol	Characteristic	Test Conditions	Min.	Typ.	Max.	Unit
• Off Characteristics						
BV_{DSS}	Drain-Source Breakdown Voltage	$V_{GS}=0V, I_D=-250\mu A$	-30	-	-	V
I_{DSS}	Zero Gate Voltage Drain Current	$V_{DS}=-24V, V_{GS}=0V$	-	-	-1	μA
I_{GSS}	Gate-Body Leakage Current	$V_{GS}=\pm 25V, V_{DS}=0V$	-	-	± 100	nA
• On Characteristics^c						
$V_{GS(th)}$	Gate Threshold Voltage	$V_{DS}=V_{GS}, I_D=-250\mu A$	-1.0	-1.5	-3.0	V
$I_{D(on)}$	On State Drain Current	$V_{DS}=-5V, V_{GS}=-10V$	60	-	-	A
$R_{DS(on)}$	Drain-Source On-State Resistance	$V_{GS}=-10V, I_D=-15A$	-	9.5	12	m Ω
		$V_{GS}=-4.5V, I_D=-12A$	-	13	15	
g_{FS}	Forward Transconductance	$V_{DS}=-10V, I_D=-5A$	-	26	-	S
• Dynamic Characteristics^d						
C_{iss}	Input Capacitance	$V_{DS}=-15V, V_{GS}=0V, f=1\text{MHz}$	-	2900	-	pF
C_{oss}	Output Capacitance		-	410	-	
C_{rss}	Reverse Transfer Capacitance		-	280	-	
R_g	Gate Resistance	$V_{DS}=0V, V_{GS}=0V, f=1\text{MHz}$	1	2	3	Ω
• Switching Characteristics^d						
Q_g	Total Gate Charge	$V_{DS}=-15V, I_D=-10A, V_{GS}=-10V$	-	48	-	nC
Q_{gs}	Gate-Source Charge		-	12	-	
Q_{gd}	Gate-Drain Charge		-	14	-	
$t_{d(on)}$	Turn-on Delay Time	$V_{DD}=-15V, I_D=-10A, V_{GS}=-10V, R_G=3\Omega$	-	15	-	nS
t_r	Turn-on Rise Time		-	11	-	
$t_{d(off)}$	Turn-off Delay Time		-	44	-	
t_f	Turn-off Fall Time		-	21	-	
t_{rr}	Reverse Recovery Time	$I_{DS}=-12A, dI/dt=100A/\mu S$	-	33	40	nS
Q_{rr}	Reverse Recovery Charge		-	23	-	nC
• Drain-Source Diode Characteristics						
V_{SD}	Drain-Source Diode Forward Voltage	$V_{GS}=0V, I_S=-1A$	-	-	-1	V
I_S	Drain-Source Diode Forward Current		-	-	-2.1	A

Note: Pulse Test: Pulse Width $\leq 300\mu s$, Duty Cycle $\leq 2\%$

Typical Electrical and Thermal Characteristics

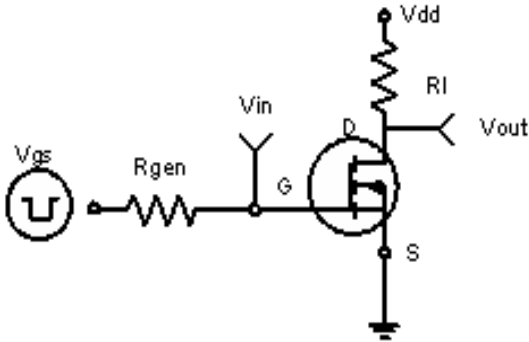

Figure 1 Switching Test Circuit

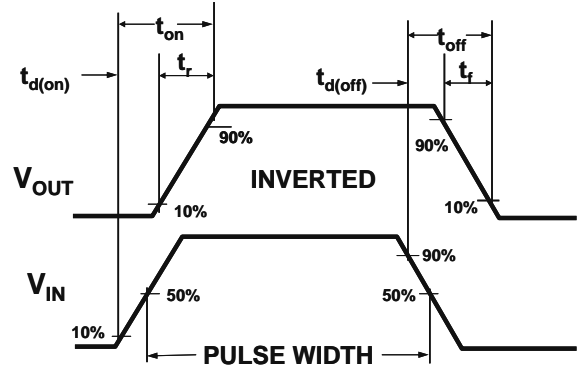

Figure 2 Switching Waveforms

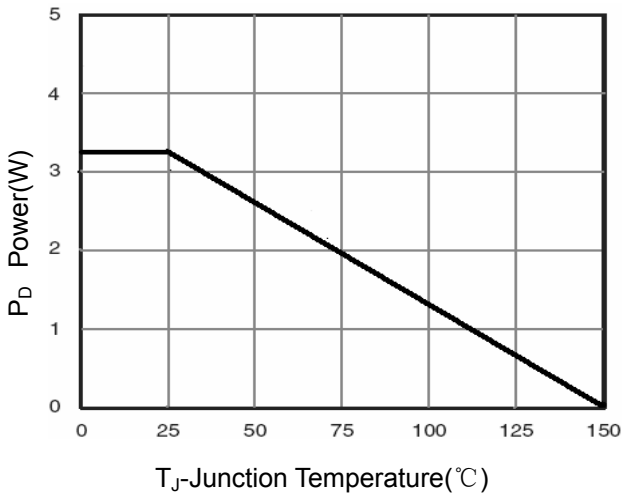

Figure 3 Power Dissipation

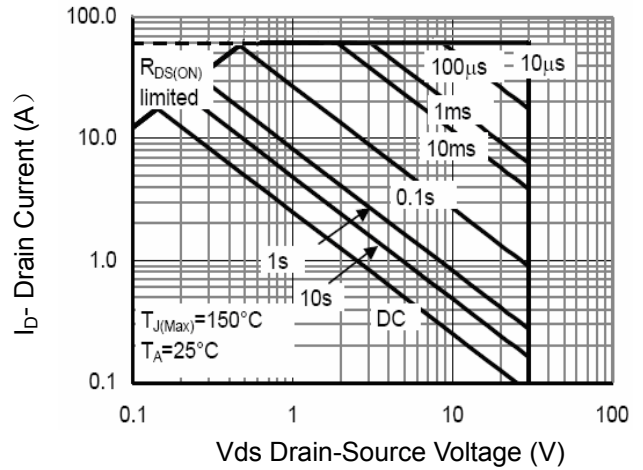

Figure 4 Safe Operation Area

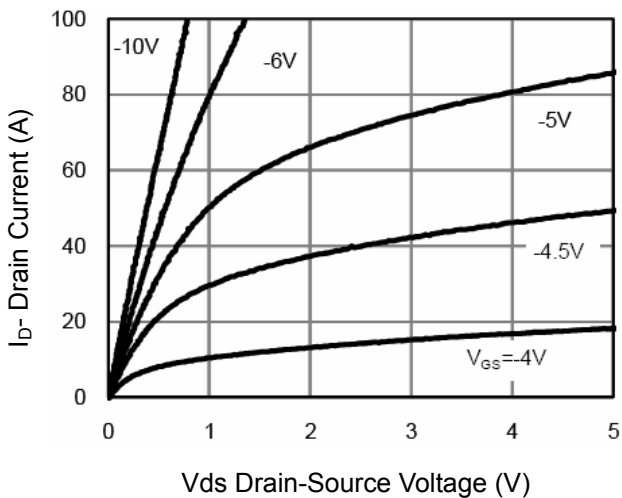

Figure 5 Output Characteristics

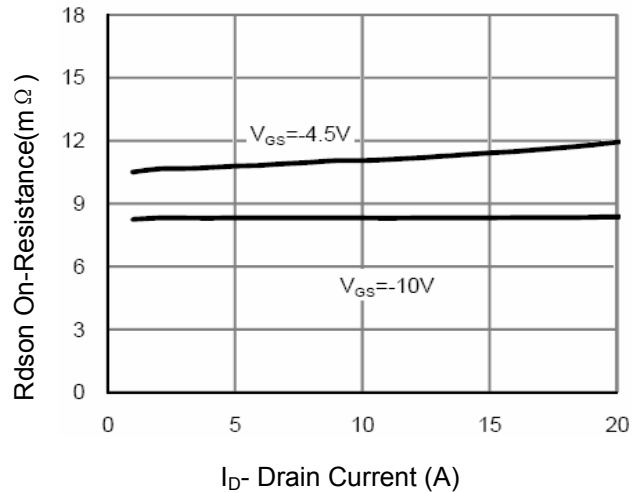

Figure 6 Drain-Source On-Resistance

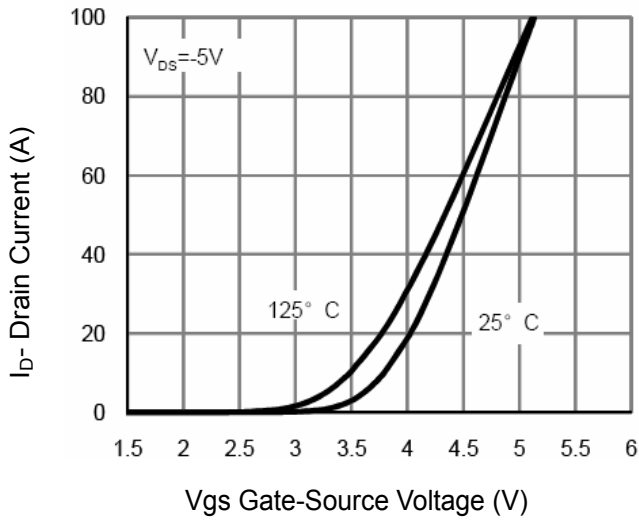

Figure 7 Transfer Characteristics

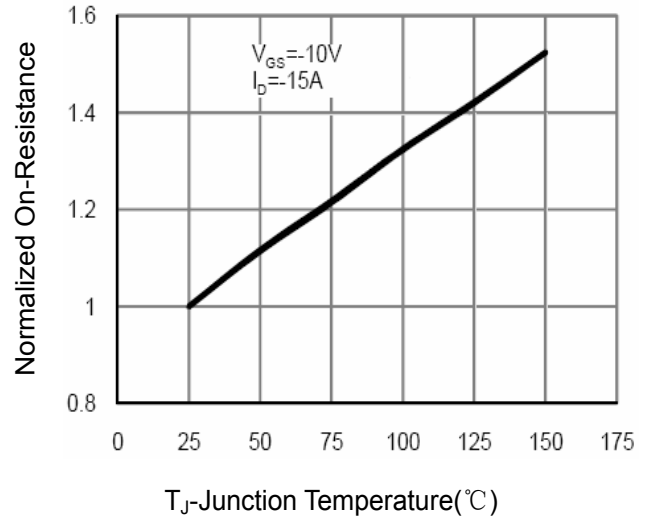

Figure 8 Drain-Source On-Resistance

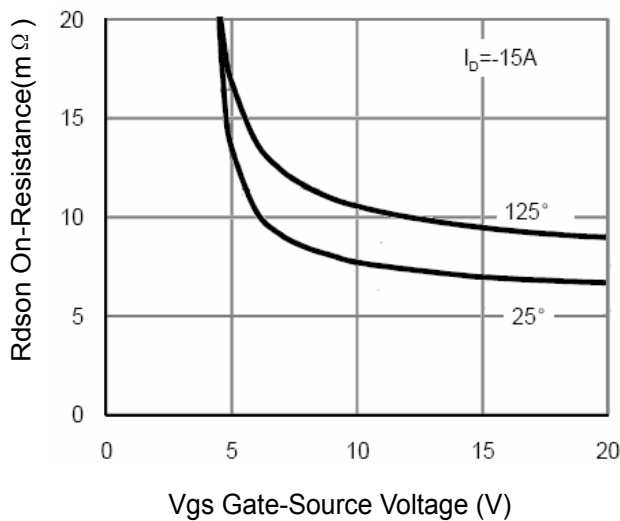

Figure 9 Rdson vs Vgs

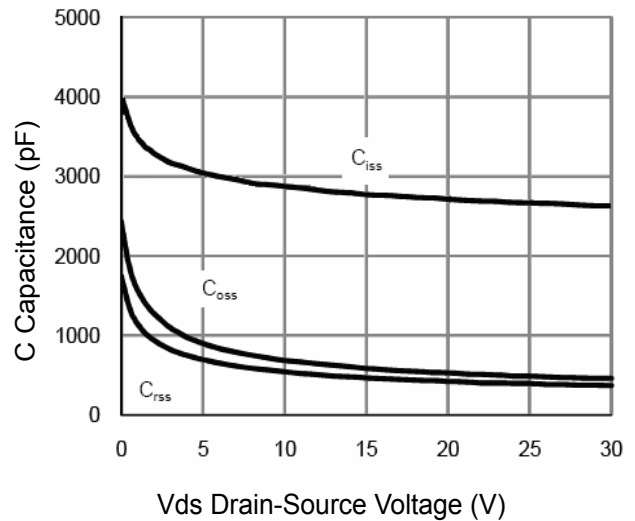

Figure 10 Capacitance vs Vds

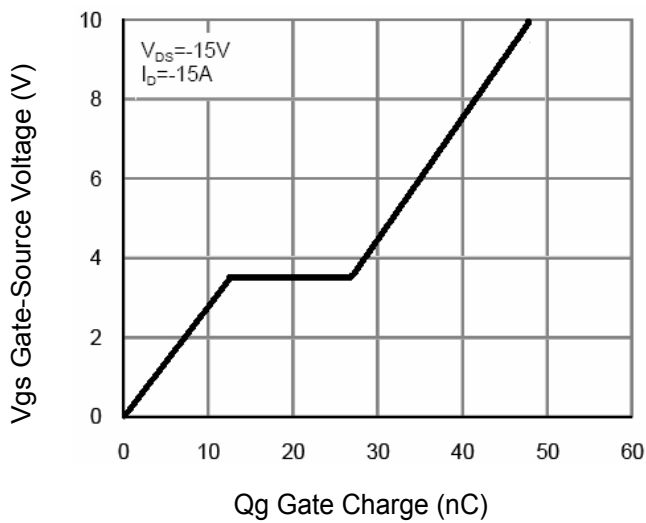

Figure 11 Gate Charge

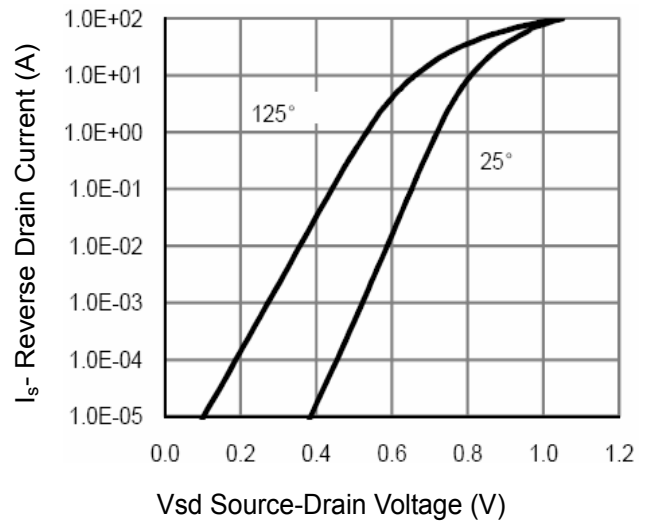

Figure 12 Source- Drain Diode Forward

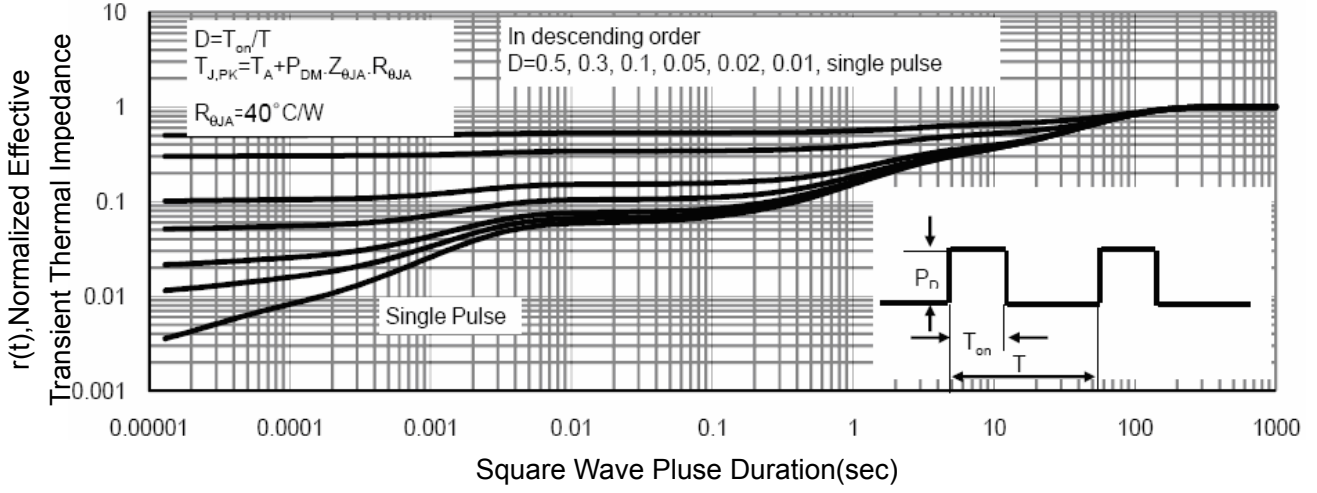
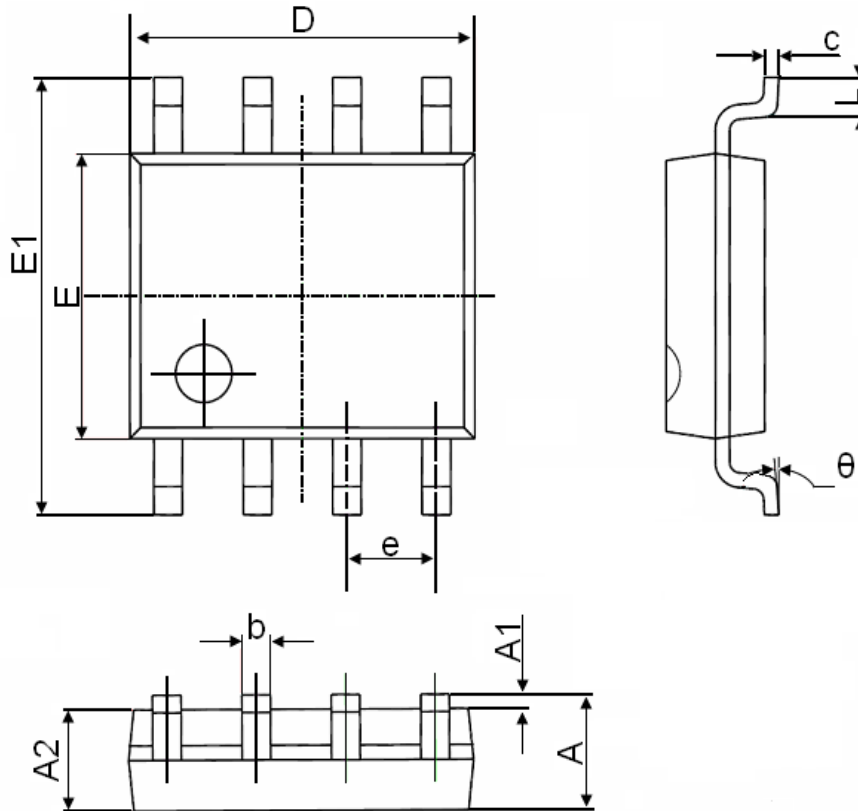

Figure 13 Normalized Maximum Transient Thermal Impedance

SOP-8 Package Information



Symbol	Dimensions In Millimeters		Dimensions In Inches	
	Min.	Max.	Min.	Max.
A	1.350	1.750	0.053	0.069
A1	0.100	0.250	0.004	0.010
A2	1.350	1.550	0.053	0.061
b	0.330	0.510	0.013	0.020
c	0.170	0.250	0.006	0.010
D	4.700	5.100	0.185	0.200
E	3.800	4.000	0.150	0.157
E1	5.800	6.200	0.228	0.244
e	1.270(BSC)		0.050(BSC)	
L	0.400	1.270	0.016	0.050
θ	0°	8°	0°	8°

单击下面可查看定价，库存，交付和生命周期等信息

[>>KUU\(永裕泰\)](#)