

**N-Channel 30-V(D-S) MOSFET**

V(BR)DSS	RDS(on)MAX	ID
30 V	55mΩ@10V	4A
	70mΩ@4.5V	
	110mΩ@2.5V	

**FEATURE**

- ※ TrenchFET Power MOSFET

**APPLICATION**

- ※ Load Switch for Portable Devices
- ※ DC/DC Converter

**MARKING**

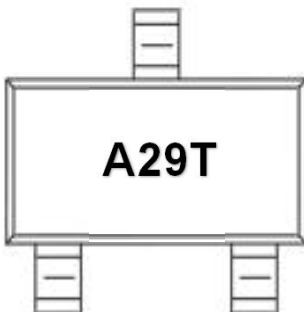

**Equivalent Circuit**

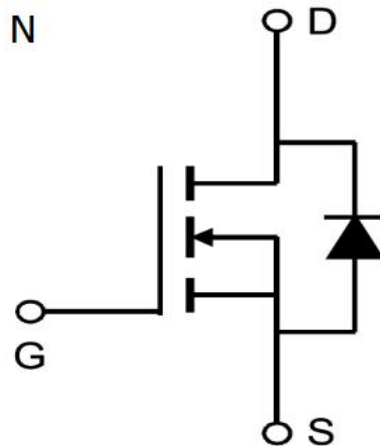

**SOT-23**

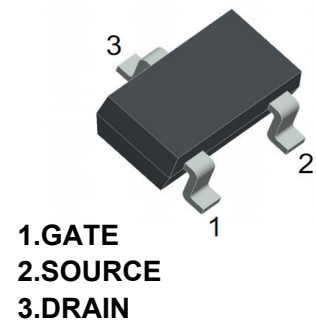

**Maximum ratings ( Ta=25°C unless otherwise noted)**

Parameter	Symbol	Value	Unit
Drain-Source Voltage	VDS	30	V
Gate-Source Voltage	VGS	±12	
Continuous Drain Current	ID	4	A
Pulsed Diode Current	IDM	15	
Continuous Source-Drain Current(Diode Conduction)	IS	0.8	
Power Dissipation	PD	1.4	W
Thermal Resistance from Junction to Ambient (t≤5s)	RθJA	125	°C/W
Operating Junction	TJ	150	°C
Storage Temperature	TSTG	-55~+150	°C

**MOSFET ELECTRICAL CHARACTERISTICS**

**Static Electrical Characteristics (Ta = 25 °C Unless Otherwise Noted)**

Parameter	Symbol	Test Condition	Min	Typ	Max	Unit
<b>Static</b>						
Drain-source breakdown voltage	V(BR)DSS	VGS = 0V, ID = 250μA	30			V
Gate-source threshold voltage	VGS(th)	VDS =VGS, ID = 250μA	0.6		1.4	V
Gate-source leakage	IGSS	VDS =0V, VGS = ±12V			±100	nA
Zero gate voltage drain current	IDSS	VDS = 30V, VGS =0V			1	μA
Drain-source on-state resistancea	RDS(on)	VGS = 10V, ID = 1A		37	55	mΩ
		VGS = 4.5V, ID = 1A		42	70	mΩ
		VGS = 2.5V, ID = 1A		53	110	mΩ
Forward transconductancea	gfs	VDS = 4.5V, ID = 4A	8			S
Diode forward voltage	VSD	IS=1A,VGS=0V		0.8	1.3	V
<b>Dynamic</b>						
Input capacitance	Ciss	VDS = 15V,VGS =0V, f=1MHz		390		pF
Output capacitance	Coss			54.5		pF
Reverse transfer capacitanceb	Crss			41		pF
Total gate charge	Qg	VDS = 15V,VGS = 4.5V, ID = 4A		11	14	nC
Gate-source charge	Qgs			1.3		nC
Gate-drain charge	Qgd			2.8		nC
Gate resistance	Rg	f=1MHz		3		Ω
<b>Switchingb</b>						
Turn-on delay time	td(on)	VDS= 15V RL=4Ω, ID ≈ 1A, VGEN= 4.5V,Rg=6Ω		3.3		ns
Rise time	tr			1		ns
Turn-off delay time	td(off)			21.7		ns
Fall time	tf			2.1		ns
<b>Drain-source body diode characteristics</b>						
Continuous Source-Drain Diode Current	IS	Tc=25°C			1.2	A
Body Diode Reverse Recovery Time	trr	IF=4A, dI/dt=100A/us		12		ns
Body Diode Reverse Recovery Charge	Qrr	IF=4A, dI/dt=100A/us		6.3		nC

**Note :**

1. Repetitive Rating : Pulse width limited by maximum junction temperature.
2. Surface Mounted on FR4 Board, t < 5 sec.
3. Pulse Test : Pulse Width≤300μs, Duty Cycle ≤ 2%.
4. Guaranteed by design, not subject to production testing.

Typical Characteristics:

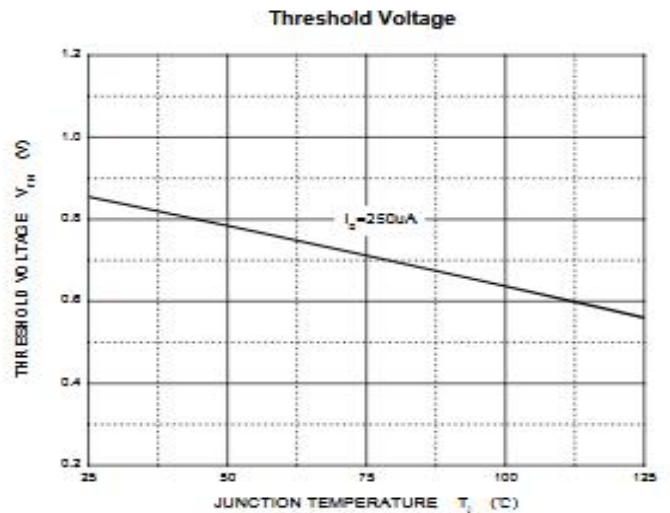
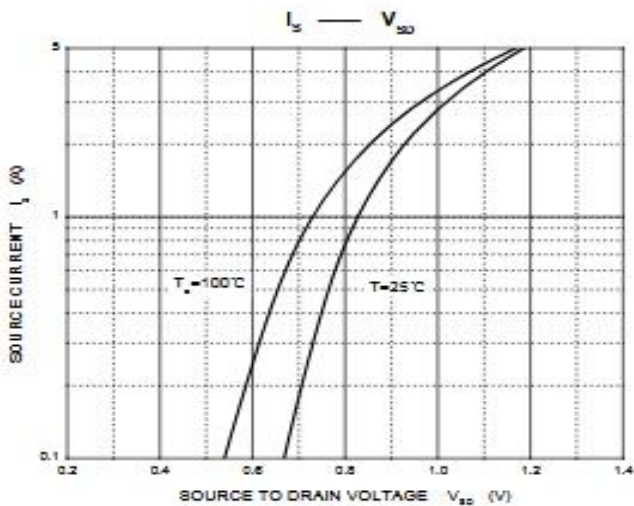
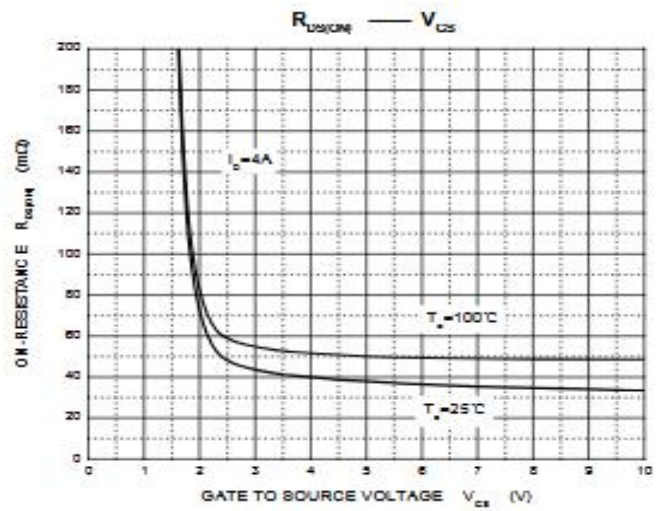
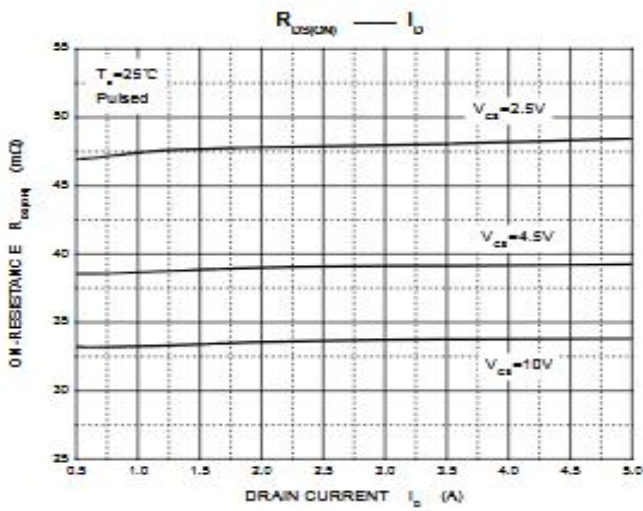
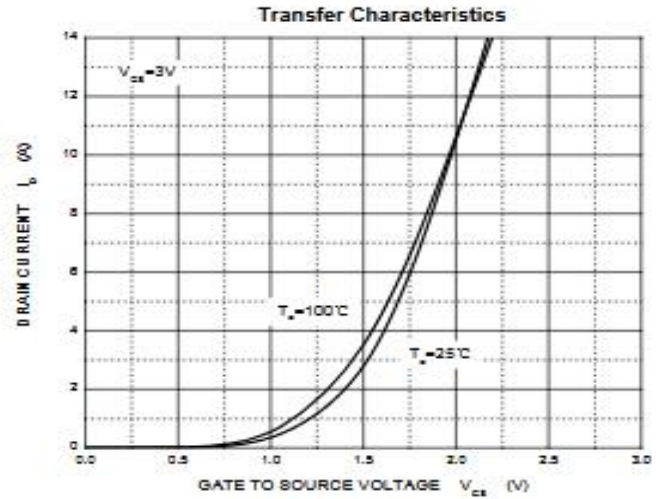
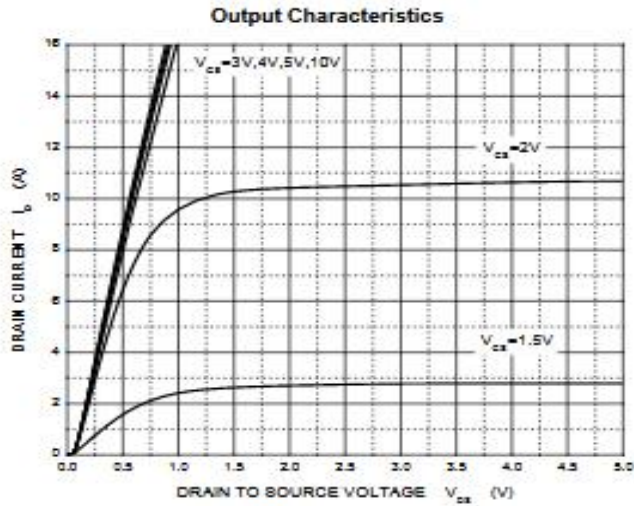

**SOT-23 PACKAGE OUTLINE DIMENSIONS**

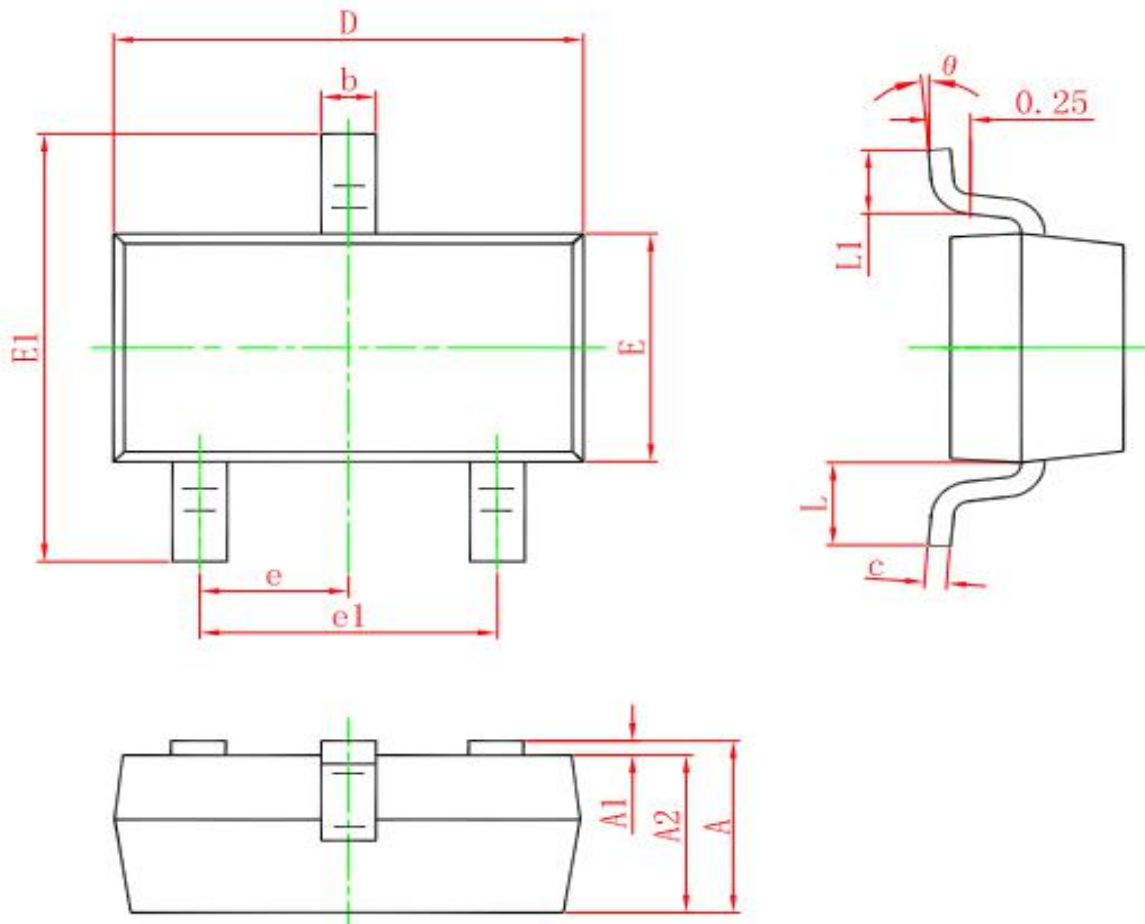

Symbol	Dimensions In Millimeters		Dimensions In Inches	
	Min.	Max.	Min.	Max.
A	0.900	1.150	0.035	0.045
A1	0.000	0.100	0.000	0.004
A2	0.900	1.050	0.035	0.041
b	0.300	0.500	0.012	0.020
c	0.080	0.150	0.003	0.006
D	2.800	3.000	0.110	0.118
E	1.200	1.400	0.047	0.055
E1	2.250	2.550	0.089	0.100
e	0.950 TYP.		0.037 TYP.	
e1	1.800	2.000	0.071	0.079
L	0.550 REF.		0.022 REF.	
L1	0.300	0.500	0.012	0.020
$\theta$	0°	8°	0°	8°

单击下面可查看定价，库存，交付和生命周期等信息

[>>KUU\(永裕泰\)](#)