

FEATURES

- ◆ Extremely Fast Switching Speed

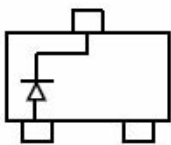

BAT54
MARKING : KL1

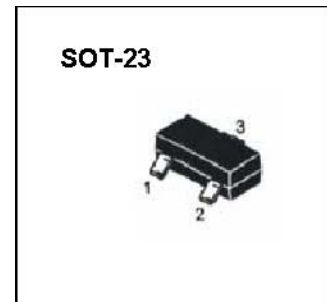
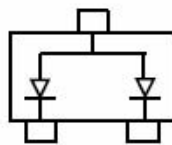

BAT54A
MARKING : KL2

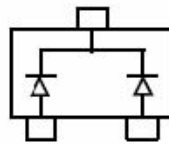

BAT54C
MARKING : KL3

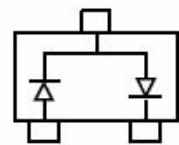

BAT54S
MARKING : KL4

Maximum Ratings @T_A=25°C

Parameter	Symbol	Limits	Unit
Peak Repetitive Peak reverse voltage Working Peak Reverse Voltage DC Blocking Voltage	V _{RRM} V _{RWM} V _R	30	V
Forward Continuous Current	I _{FM}	200	mA
Power Dissipation	P _D	200	mW
Storage temperature	T _{STG}	-55-150	°C

Electrical Characteristics @T_A=25°C

Parameter	Symbol	Min.	Typ.	Max.	Unit	Conditions
Reverse Breakdown Voltage	V _{(BR)R}	30			V	I _R =100μA
Forward voltage	V _{F1}			0.24	V	I _F =0.1mA
	V _{F2}			0.32	V	I _F =1mA
	V _{F3}			0.40	V	I _F =10mA
	V _{F4}			0.50	V	I _F =30mA
	V _{F5}			1	V	I _F =100mA
Reverse current	I _R			2	μA	V _R =25V
Diode Capacitance	C _D			10	pF	V _R =1V, f=1MHz
Reverse Recovery Time	t _{rr}			5	nS	I _F =I _R =10mA I _{rr} =0.1X I _R , R _L =100Ω

Typical Characteristics

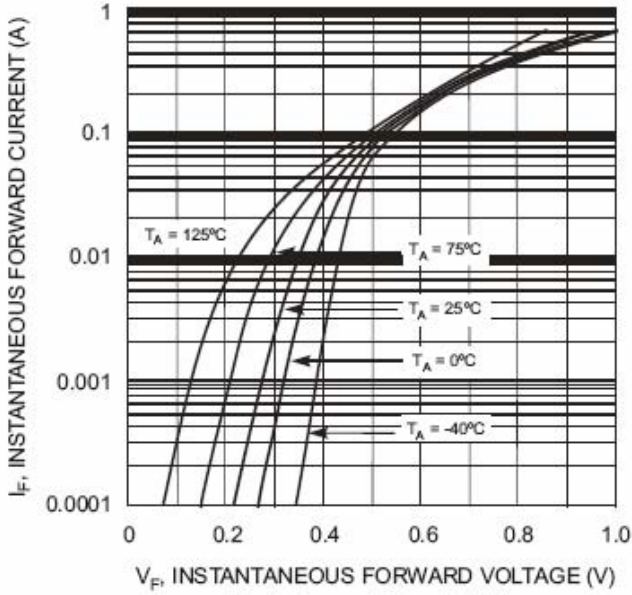

Fig. 1 Forward Characteristics

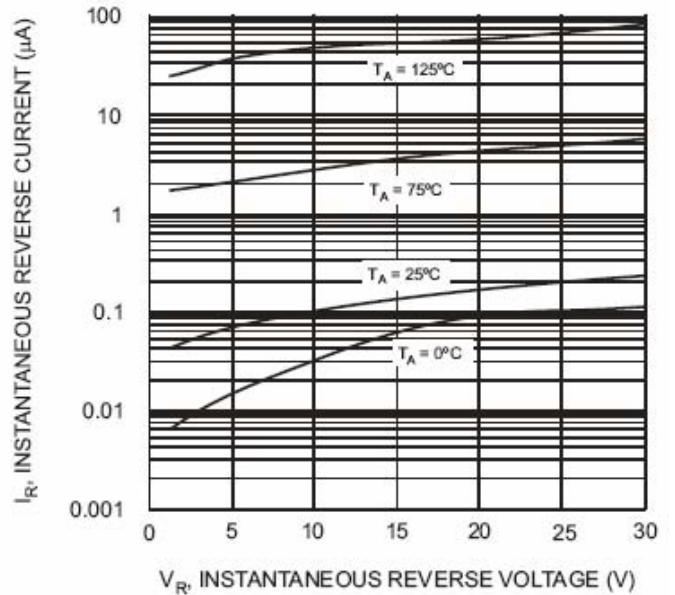

Fig. 2 Typical Reverse Characteristics

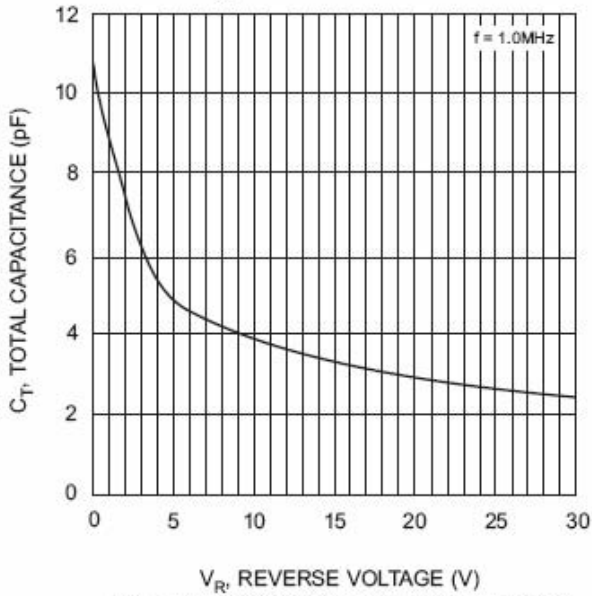

Fig. 3 Typical Capacitance vs. Reverse Voltage

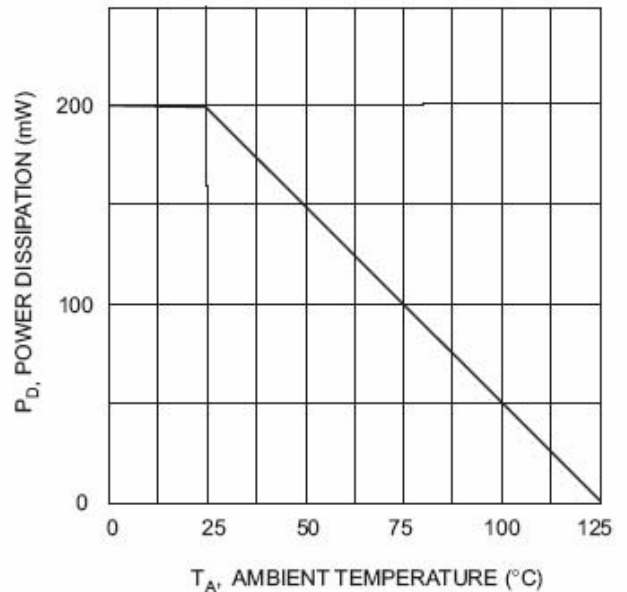

Fig. 4 Power Derating Curve

单击下面可查看定价，库存，交付和生命周期等信息

[>>KUU\(永裕泰\)](#)