

Description

KAU0511P1 polymeric ESD suppressor help protect sensitive electronic equipment against electrostatic discharge (ESD) without distorting data signals. This protection is a result of its ultra-low capacitance of only 0.05 pF (I/O to GND), and it can be used to help equipment to pass IEC61000-4-2 level 4 test (15KV air, 8KV contact discharge).

(EIA Size) 0402



Features

- ◆ Ultra low capacitance,0.05pF(typ.).
- ◆ Fast response time(<1ns).
- ◆ Low leakage current(<10nA).
- ◆ Bi-directional, single line protection.
- ◆ IEC61000-4-2(Contact): 8KV, IEC61000-4-2(Air) :15KV.

Equivalent Circuit

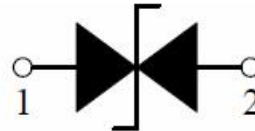

Applications

- ◆ Smart Phone/Mobile Internet Device.
- ◆ Laptop/Desktop Computer.
- ◆ Antennas (Cell Phones, GPS...).
- ◆ USB 3.0,USB 3.1 and high speed interface.

General Characteristics

Parameter	Max	Unit
Contact Discharge Voltage Per IEC61000-4-2	8	KV
Air Discharge Voltage Per IEC61000-4-2	15	KV
Operating Temperature	-55 to +125	°C
Storage Temperature	-40 to +85	°C

Electrical Characteristics (T_A = 25°C)

Parameter	Symbol	Test Conditions	Min.	Typ.	Max.	Units
Continuous Operating Voltage	V _{DC}	--	--	--	5	V
Trigger Voltage	V _T	IEC61000-4-2 8KV contact discharge	--	450	--	V
Clamping Voltage	V _C	IEC61000-4-2 8KV contact discharge	--	40	--	V
Leakage Current	I _L	DC 5V shall be applied on component	--	--	10	nA
Capacitance	C _P	Measured at 10MHz	--	0.05	--	pF
ESD Pulse Withstand	Pulses	IEC61000-4-2 8KV contact discharge	1000	--	--	--

Note:

Trigger and clamping voltage are measured per IEC 61000-4-2, 8KV contact discharge method.

Typical ESD Response (IEC 61000-4-2, 8KV contact discharge)

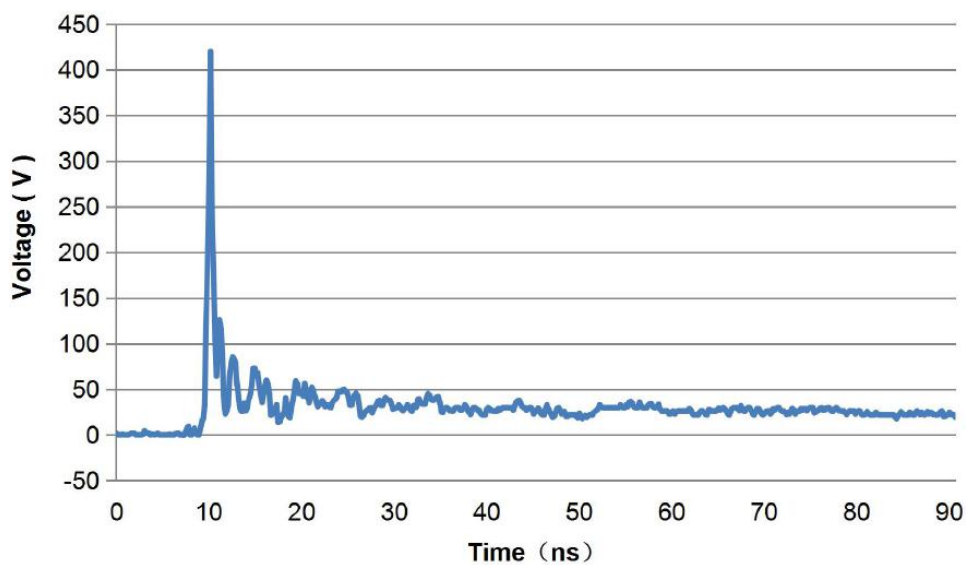
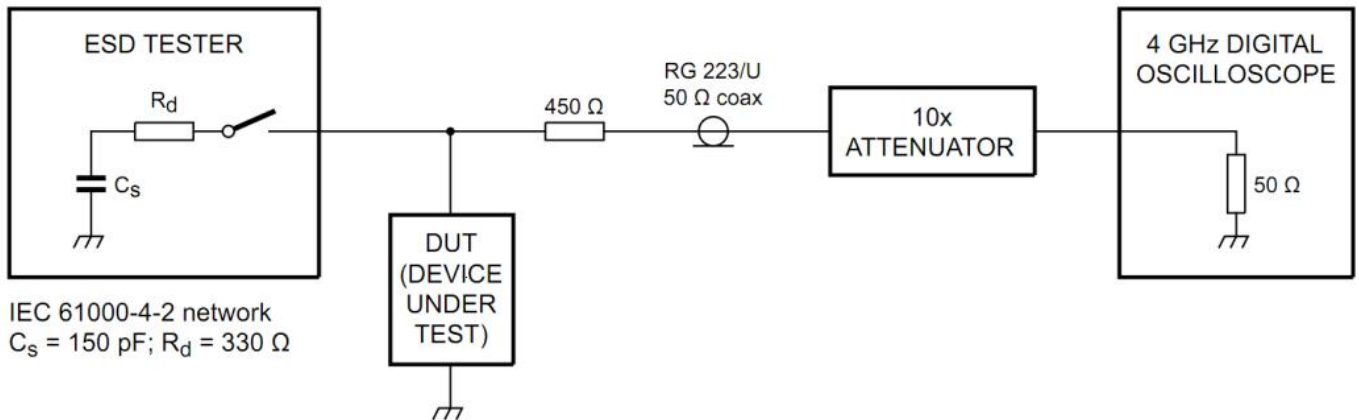

Typical Device Capacitance VS. Frequency

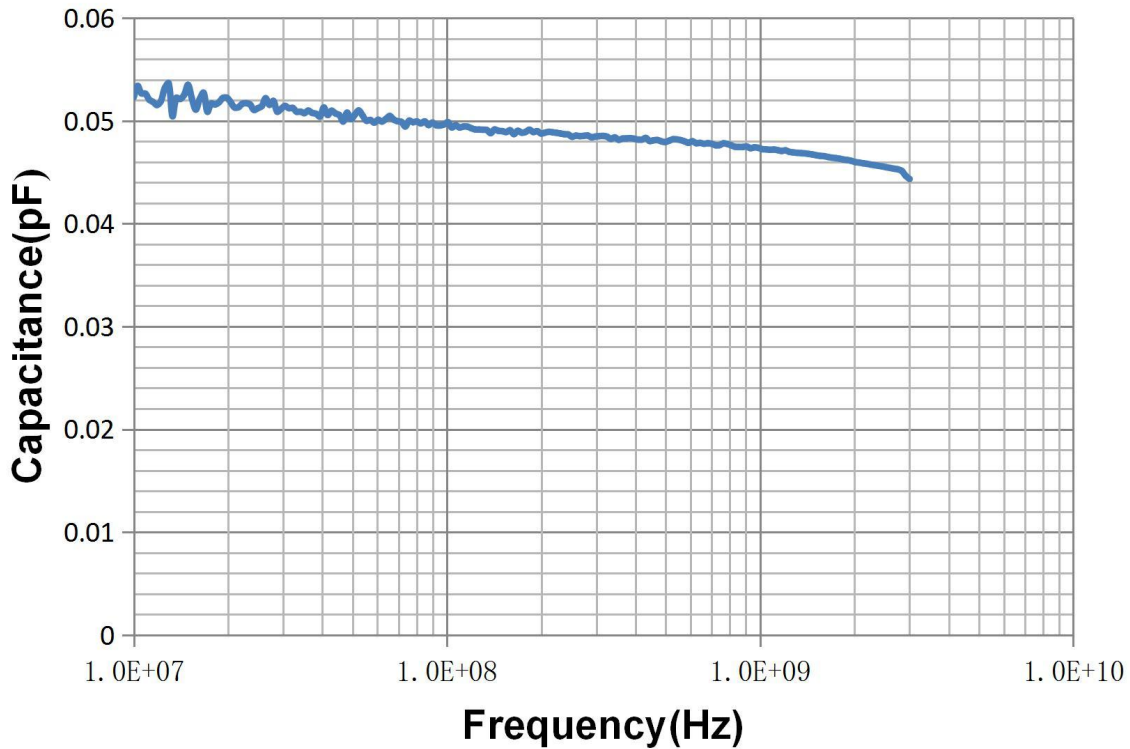

Soldering Parameters

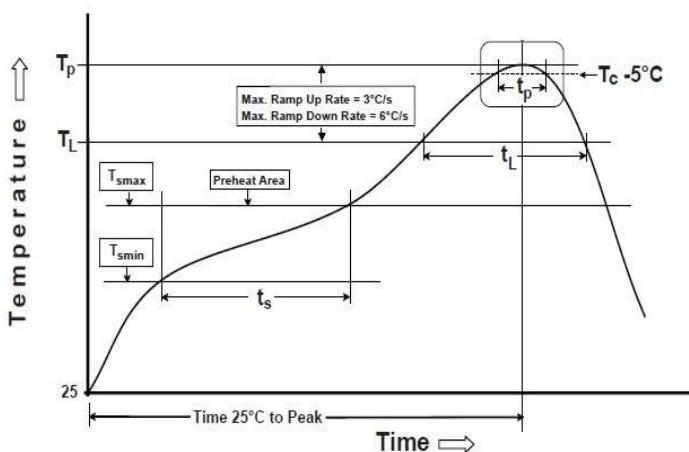

Profile Feature		Pb-Free Assembly
Pre Heat	Temperature Min (T_{smin})	150°C
	Temperature Max (T_{smax})	200°C
	Time (T_s) from (T_{smin} to T_{smax})	60-120 seconds
Ramp-up Rate (T_L to T_P)		3°C/second max.
Liquidus Temperature (T_L)		217°C
Time (t_L) maintained above T_L		60-150 seconds
Peak Package Body Temperature (T_P)		260 ^{+0/-5} °C
Time (t_p)* within 5°C of the Specified Classification Temperature (T_c)		30* seconds
Ramp-down Rate (T_P to T_L)		6°C/second max.
Time 25°C to peak Temperature		8 minutes Max
* Tolerance for peak profile temperature (T_P) is defined as a supplier minimum and a user maximum.		

Package Dimension

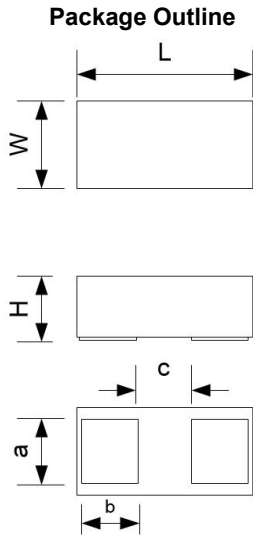

Dimension	Unit: Millimeters		
	Min.	Typ.	Max.
L	0.98	1.00	1.03
W	0.48	0.50	0.53
H	0.35	0.38	0.40
a	0.35	0.38	0.40
b	0.30	0.30	0.35
c	0.24	0.26	0.29

Recommended Solder Pad Footprint

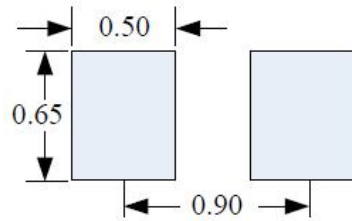

Sizes in mm

Notes:

This solder pad layout is for reference purposes only.

单击下面可查看定价，库存，交付和生命周期等信息

[>>KUU\(永裕泰\)](#)