

**Messrs: Digi-Key**

**Specification**

※In the case of specification change, KKC Part Number also will change.

Customer part number	-
Customer specification Number	-
Product	Quartz Crystal
Model	CX3225GB
Frequency	per KB101-11315-431 3/12
KKC Part Number	per KB101-11315-431 3/12

**【RoHS compliant, MSL 1】**

[STAMP]

**Sales office**  
 KYOCERA Corporation  
 (Electronic Components Sales Division)  
 Head Office 6 Takeda Tobadono-cho, Fushimi-ku,  
 Kyoto 612-8501 Japan  
 TEL 075-604-3500  
 FAX 075-604-3501

**Production**  
 KYOCERA KINSEKI Corporation  
 (Crystal Unit Sales Promotion Division)  
 1-8-1, Izumi-honcho, Komae-Shi,  
 Tokyo 201-8648 Japan  
 TEL 03-5497-3111  
 FAX 03-5497-3209

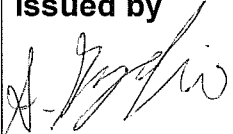
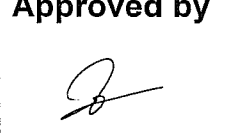
<b>Design</b> KYOCERA KINSEKI Yamagata Co. Crystal Units Overseas Design Section Crystal Units Division 1	<b>Issued by</b> 	<b>Approved by</b> 
--	--	---

※Recycled paper is being used for the conservation of nature.

Date: 2011/ 8/ 4

### Change History

Rev	DESCRIPTION	DATE	DRAWN	CHECKED	APPROVED
0	Spec release	2011/ 8/ 4	<i>A. J. J. J.</i>	<i>M. J. J. J.</i>	<i>J. J. J. J.</i>

Date: 2011/ 8/ 4

**[PART NUMBER LIST]**

Nominal Frequency (MHz)	KKC Part number	ESR ( $\Omega$ )	Nominal Frequency Code
10	CX3225GB10000D0HPQZ1	300	10000
12	CX3225GB12000D0HPQZ1	250	12000
14.31818	CX3225GB14318D0HPQZ1	100	14318
16	CX3225GB16000D0HPQZ1	80	16000
20	CX3225GB20000D0HPQZ1	60	20000
24	CX3225GB24000D0HPQZ1	60	24000
25	CX3225GB25000D0HPQZ1	60	25000
27	CX3225GB27000D0HPQZ1	50	27000
32	CX3225GB32000D0HPQZ1	50	32000
40	CX3225GB40000D0HPQZ1	50	40000
48	CX3225GB48000D0HPQZ1	50	48000

**1. APPLICATION**

This specification sheet is applied to quartz crystal "CX3225GB".

**2. PART NUMBER**

per KB101-11315-431 3/12

**3. RATINGS**

Items	SYMB.	Rating	Unit	Remarks
Operating Temperature	Topr	-40~+85	°C	
Storage Temperature range	Tstg	-40~+85	°C	

**4. CHARACTERISTICS****4-1 ELECTRICAL CHARACTERISTICS**

Items	Electrical Specification					Test Condition	Remarks
	SYMB.	Min	Typ.	Max	Unit		
Mode of Vibration		Fundamental					
Nominal Frequency	F0		※		MHz		
Nominal Temperature	T <sub>NOM</sub>		25		°C		
Load Capacitance	CL		8.0		pF		
Frequency Tolerance	df/F	-20.0		+20.0	PPM	+25±3°C Network Analyzer E5100A 200 μ A	
Frequency Temperature characteristics	df/F	-30.0		+30.0		-40~+85°C	+25±3°C
Frequency Aging Rate		-5.0		+5.0		1 year	+25±3°C
Equivalent Series Resistance	ESR			※	Ohms	Network Analyzer E5100A 200 μ A	
Drive Level	Pd	0.01		100	μ W		
Insulation Resistance	IR	500			M ohms	100V(DC)	

※ per KB101-11315-431 3/12

## 5. APPEARANCES, PHYSICAL DIMENSION OUTLINE DIMENSION (not to scale)

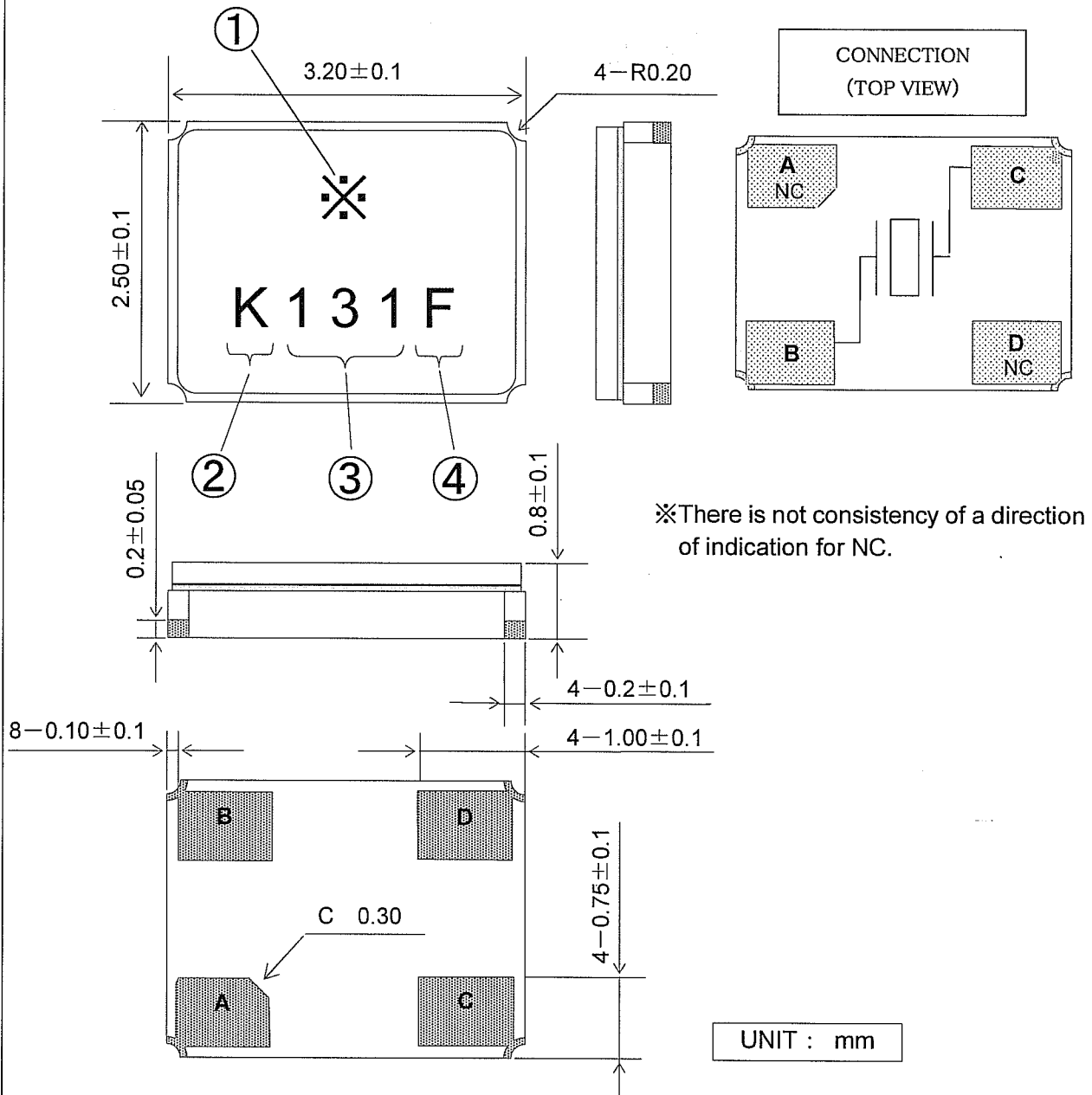

### MARKING

① Nominal Frequency

Move the number of maximum indication beams of the frequency to five digits, and omit less than kHz.

※ per KB101-11315-431 3/12

② Identification

③ Date Code

Year...LAST 1 DIGIT of YEAR AND WEEK

※ For details to LOT CALENDAR

(Ex) AUG. 4, 2011 → 131

④ Manufacturing Location

F...KYOCERA KINSEKI Philippines, Inc.

※The font of marking is reference.

**6. RECOMMENDED LAND PATTERN (not to scale)**

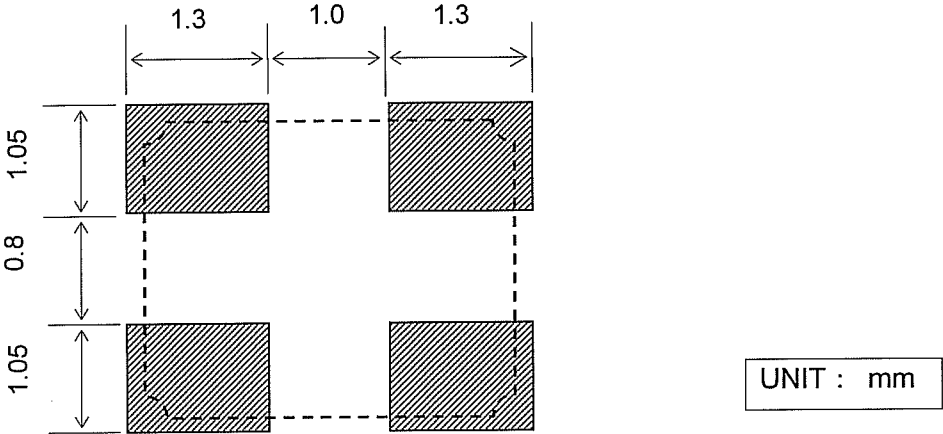

**7. Quality Assurance**

Location

KYOCERA KINSEKI Philippines, Inc. : KYOCERA KINSEKI Philippines, Inc. Quality Assurance Division

Quality guarantee

When the failure by the responsibility of our company occurs clearly after delivery within 1 year, a substitute article etc. is appropriated gratuitously and this is guaranteed. However, when passing 1 year after delivery, there is a case where I am allowed to consider as onerous repair after both consultation.

## 8.TAPING & REEL 梱包補助材

### 8-1.Dimensions (寸法図)

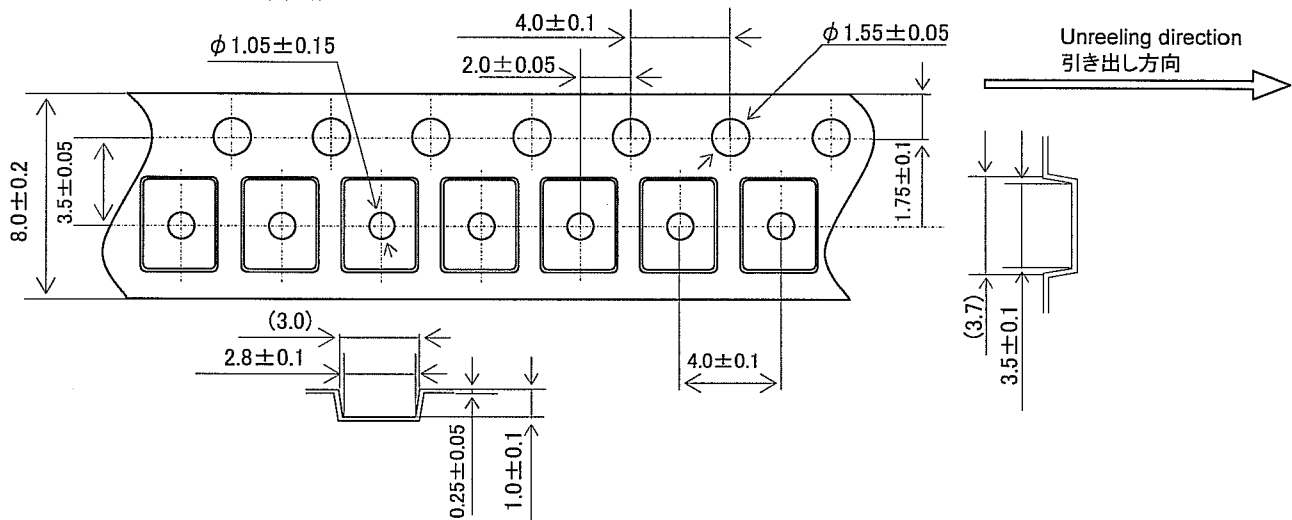

### 8-2.Leader and trailer tape (リーダー部テープ部及び終末端部テープ)

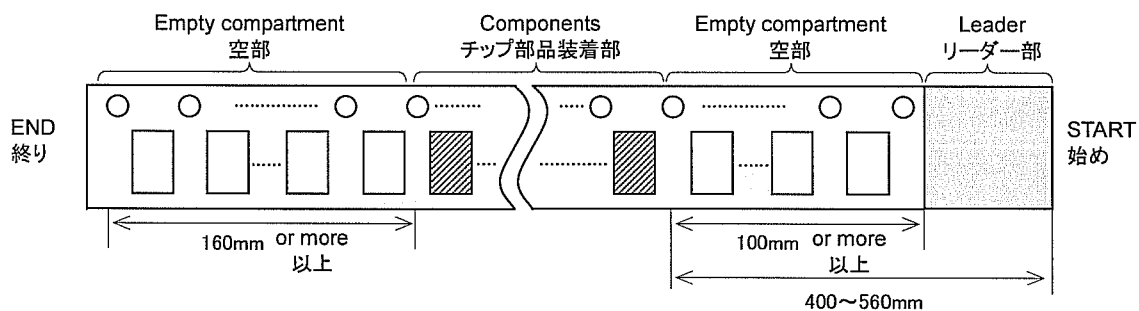

### 8-3.Direction (The direction shall be seen from the top cover tape side)

テーピング方向(トップカバーテープ側から見る。)

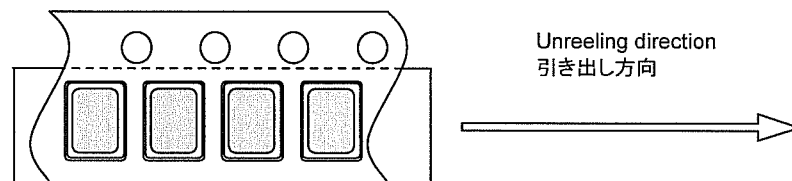

### 8-4.Specification (記事)

1. Material of the carrier tape shall be PS (ESD). {装着テープの材質は、PS とする。(静電対策品)}
2. Material of the seal tape shall be polyester(ESD). {シールテープの材質はポリエステルとする。(静電対策品)}
3. The seal tape shall not cover the sprocket holes. And not protrude from the carrier tape. {シールテープは送り穴をふさいだり、装着テープからはみ出していないこと。}
4. Tensile strength of the tape : 10N or more. {テープの引張り強度は 10N 以上}
5. The R of the corner without designation is 0.2RMAX. {指定無きコーナーの R は 0.2RMAX}
6. Disalignment between centers of the cavity and sprocket hole shall be 0.05mm or less. {角穴の中心と送り穴の中心とのずれは、0.05mm 以下とする。}
7. Cumulative pitch tolerance of "P<sub>0</sub>" shall be  $\pm 0.2\text{mm}$  at 10 pitches. {"P<sub>0</sub>"の累積ピッチ許容差は、10 ピッチで $\pm 0.2\text{mm}$  とする。}
8. The number of lack is 0.1% of 1 reel total part number (the number of the table letters) or the part following whose 1 either is big. (But, the thing which lack of the continuance is not in.) {欠落数は、1 リールの総部品数(表示数)の 0.1%、又は、1 個のいずれか大きい方以下。(但し、連続の欠落のないこと。)}
9. The marking on parts is not fixed its direction, its electrical characteristic is equal. {エンボステープ内での製品表示向きが一定ではないが、電気的特性に影響は無し。}
10. Peeling force of the seal tape: 0.3 to 0.7N. {シールテープ剥離強度 0.3~0.7N}

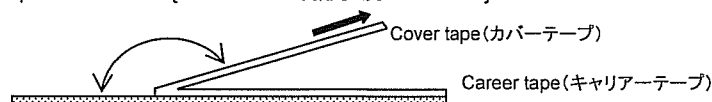

8-5.Reel specifications リール仕様

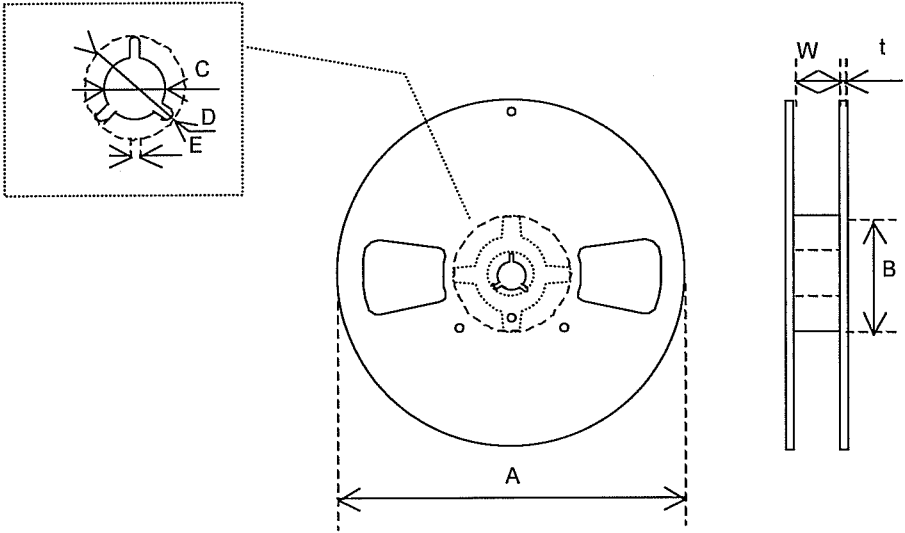

(Nonconductor type Reel)

In the case of Φ 180 Reel(1000 or 3000 pcs)

	A	B	C	D
Dimension	$\phi 180 +0/-1.5$	$\phi 60 +1/-0$	$\phi 13 \pm 0.2$	$\phi 21 \pm 0.8$
Symbol	E	W	t	
Dimension	$2.0 \pm 0.5$	$9 \pm 1$	$2.0 \pm 0.5$	

(Unit : mm)



## 9. Enviromental requirements

After following test, frequency shall not change more than  $\pm 10 \times 10^{-6}$

And CI,  $\pm 20\%$  or  $5\Omega$  of large value.

- 9.1 Resistance to Shock      Test condition  
Natural dropped from height 100cm onto hard wood board in 3 times
- 9.2 Resistance to Vibration      Test condition  
frequency                      : 10—55 — 10 Hz  
Amplitude                      : 1.5mm  
Cycle time                      : 15 minutes  
Direction                      : X,Y,Z (3direction),2 h each.
- 9.3 Resistance to Heat      Test condition  
The quartz crystal unit shall be stored at a temperature of  $+85 \pm 2^\circ\text{C}$  for 500 h.  
Then it shal be subjected to standard atmospheric conditions for 1 h ,after whichi measurement shall be made.
- 9.4 Resistance to Cold      Test condition  
The quartz crystal unit shall be stored at a temperature of  $-40 \pm 2^\circ\text{C}$  for 500 h.  
Then it shal be subjected to standard atmospheric conditions for 1 h ,after whichi measurement shall be made.
- 9.5 Thermal Shock      Test condition  
The quartz crystal unit shall be subjected to 500 succesive change of temperature cycles , each as shown in table below, Then it shall be subjected to standard atmospheric conditions for 1h, after which measurements shall be made.  
Cycle                      :  $-40 \pm 2^\circ\text{C}$  (30min.)  $\sim 25 \pm 2^\circ\text{C}$  (5min.)  
                                     $\sim +85 \pm 2^\circ\text{C}$  (30min.)  $\sim 25 \pm 2^\circ\text{C}$  (5min.)

## 9.6 Resistance to Moisture

## Test condition

The quartz crystal unit shall be stored at a temperature of  $60 \pm 2^\circ\text{C}$  with relative humidity of 90% to 95% for 240 h. Then it shall be subjected to standard atmospheric conditions for 1h, after which measurements shall be made

## 9.7 Soldering condition

## 1) Material of solder

Kind ... lead free solder paste

Melting point ...  $220 \pm 5^\circ\text{C}$

## 2) Temp.profile of reflow soldering system

	Temp [ $^\circ\text{C}$ ]	Time[sec]
Peak	$260 \pm 5$	10 (max.)
Preheating	180 (typ.)	100 (typ.)
Total	—	200 (max.)

Temp. profile of reflow

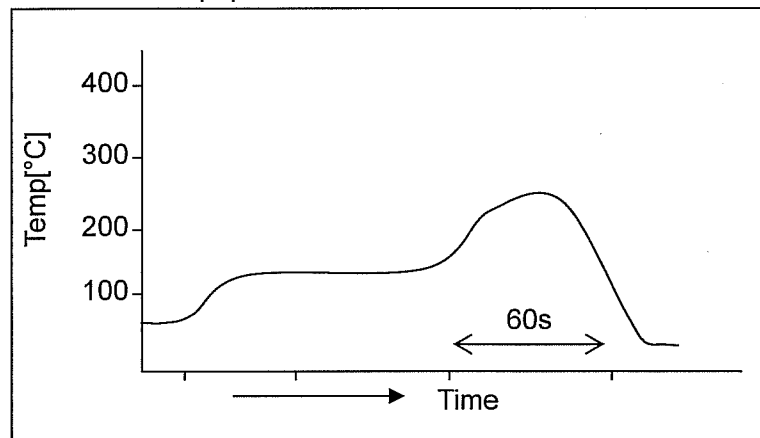
3) Hand Soldering Temperature:  $350^\circ\text{C}$ , Time: 3sec

## 9.8 Intensity for bending in circuit board

Solder this product in center of the circuit board of  $40\text{mm} \times 100\text{mm}$ , and add the deflection of 3mm as the bottom figure.

Test board :  $t = 1.6\text{mm}$

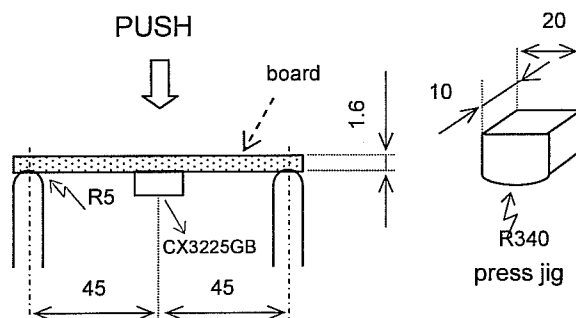

UNIT : mm

## 10. Cautions for use

### (1) Automatic mounting machine use

Please use after affirmation that select the mounting machine model with a shock small if possible in the case of use of an automatic mounting machine, and it does not have breakage. There is a risk of a quartz crystal unit breakage occurring and not functioning normally by too much shock etc..

### (2) Conformity of a circuit

In case of use of an oscillation circuit, please insert in a quartz crystal unit in series resistance 5 time as many as the standard value of equivalent in-series resistance, and confirm oscillating. Please remove resistance which inserted after the notes above-mentioned examination in the quartz crystal unit in series, and use it.

### (3) After making the Quartz Crystal mount on a printed circuit board ,if it is required to devide the printed circuit board into another one, use it with attentive confirmation so that a warp caused by this dividing might not affect any damage. When designing a printed circuit board as well as handling the mounting As much as possible. The quartz crystal shall be passed through the reflow furnace. Then it shall be subjected to standard atmospheric conditions, after which cleaning shall be made.

## 11. Storage conditions

Storage at prolonged high temperature or low temperature and the storage by high humidity cause degradation of frequency accuracy, and degradation of soldering nature. Storage is performed at the temperature of 18-30 degrees C, and the humidity of 20-70 Percent in the state of packing, and a term is 6 months.

## 12. Others

When any questions and opinions are in the written matter of these delivery specifications, I will ask connection of you from the our company issue day within 45 days. In a connection no case, a written matter is consented to it and employed within a term.

Date: 2011/ 8/ 4

### 13.LOT CALENDAR

WEEK	MONTH	MON	TUE	WED	THU	FRI	SAT	SUN	WEEK	MONTH	MON	TUE	WED	THU	FRI	SAT	SUN
週	月	月	火	水	木	金	土	日	週	月	月	火	水	木	金	土	日
1053	1						1	2	1127	7	4	5	6	7	8	9	10
1101		3	4	5	6	7	8	9	1128		11	12	13	14	15	16	17
1102		10	11	12	13	14	15	16	1129		18	19	20	21	22	23	24
1103		17	18	19	20	21	22	23	1130		25	26	27	28	29	30	31
1104		24	25	26	27	28	29	30	1131	8	1	2	3	4	5	6	7
1105	2	31	1	2	3	4	5	6	1132		8	9	10	11	12	13	14
1106		7	8	9	10	11	12	13	1133		15	16	17	18	19	20	21
1107		14	15	16	17	18	19	20	1134		22	23	24	25	26	27	28
1108		21	22	23	24	25	26	27	1135	9	29	30	31	1	2	3	4
1109	3	28	1	2	3	4	5	6	1136		5	6	7	8	9	10	11
1110		7	8	9	10	11	12	13	1137		12	13	14	15	16	17	18
1111		14	15	16	17	18	19	20	1138		19	20	21	22	23	24	25
1112		21	22	23	24	25	26	27	1139	10	26	27	28	29	30	1	2
1113	4	28	29	30	31	1	2	3	1140		3	4	5	6	7	8	9
1114		4	5	6	7	8	9	10	1141		10	11	12	13	14	15	16
1115		11	12	13	14	15	16	17	1142		17	18	19	20	21	22	23
1116		18	19	20	21	22	23	24	1143		24	25	26	27	28	29	30
1117	5	25	26	27	28	29	30	1	1144	11	31	1	2	3	4	5	6
1118		2	3	4	5	6	7	8	1145		7	8	9	10	11	12	13
1119		9	10	11	12	13	14	15	1146		14	15	16	17	18	19	20
1120		16	17	18	19	20	21	22	1147		21	22	23	24	25	26	27
1121		23	24	25	26	27	28	29	1148	12	28	29	30	1	2	3	4
1122	6	30	31	1	2	3	4	5	1149		5	6	7	8	9	10	11
1123		6	7	8	9	10	11	12	1150		12	13	14	15	16	17	18
1124		13	14	15	16	17	18	19	1151		19	20	21	22	23	24	25
1125		20	21	22	23	24	25	26	1152		26	27	28	29	30	31	
1126	7	27	28	29	30	1	2	3									

单击下面可查看定价，库存，交付和生命周期等信息

[>>Kyocera\(京瓷\)](#)