

How to Order

■ Features

- Kyocera's series of Multilayer Ceramic Chip Capacitors are designed to meet a wide variety of needs. We offer a complete range of products for both general and specialized applications.
- We have a network worldwide in order to supply our global customer bases quickly and efficiently.
- All our products are highly reliable due to their monolithic structure of high-purity and superfine uniform ceramics and their integral internal electrodes.
- Our stringent quality control in every phase of production from material procurement to shipping ensures consistent manufacturing and superior quality.
- Kyocera components are available in a wide choice of dimensions, temperature characteristics, rated voltages, and terminations to meet specific configurational requirements.



e.g.)

KGM **03** **C** **R5** **0J** **225** **M** **H** □□□□
 ① ② ③ ④ ⑤ ⑥ ⑦ ⑧ Option Code (When needed)

- ① Series : KGM Series(General)
- ② Size (EIA) : 0201
- ③ Thickness (max.) : 0.39mm
- ④ Dielectric : Operating Temperature Range: -55 to 85°C/
ΔC max.: ±15%/ Standard Temperature: 25°C
- ⑤ Rated Voltage : 6.3Vdc
- ⑥ Capacitance : 2.2μF
- ⑦ Tolerance : ±20%
- ⑧ Packaging : Taping Material Paper/ Taping Width 8mm/
Cavity Pitch 2mm/ Reel Size φ180

① Series Code

CODE	Type
KGM	General
KGT	Low Profile
KGU	High-Q
KAM	Automotive
KGN	Three Terminal Capacitors

② Size Code

CODE	EIA	JIS
02	01005	0402
03	0201	0603
05	0402	1005
15	0603	1608
21	0805	2012
31	1206	3216
32	1210	3225

③ Thickness (max.)

CODE	EIA	JIS	Thickness Code	Thickness(max.)
02	01005	0402	A	0.22
03	0201	0603	A	0.33
			B	0.35
			C	0.39
			D	0.55
			Y	0.22
05	0402	1005	A	0.55
			B	0.65
			C	0.7
			D	0.8
			X	0.22
			Y	0.33
			Z	0.5
15	0603	1608	A	0.9
			C	1.0
			A	1.45
21	0805	2012	C	0.95
			A	1.8
31	1206	3216	F	1.75
			H	1.9
			L	0.95
			A	2.7
32	1210	3225	A	2.7

④ Dielectric Code

Temperature Compensation Type			
CODE	Temperature Range(°C)	ppm/°C	
CG	-55 ~ 125	0	±30
CH			±60

· All parts of COG will be marked as "CG" but will conform to the above table.
 · Temperature coefficients are determined by calculation based on measurement at 20°C and 85°C.

High Dielectric Constant Type			
CODE	Temperature Range(°C)	ΔC (%)	Reference Temp.°C
R5	-55 ~ 85	±15	25
S6		±22	
T6	-55 ~ 105	+22/-33	
R7		±15	
K7*	-55 ~ 125	±15	
S7		±22	
T7		+22/-33	

*Special spec: Change in capacitance under 50% of rated voltage applied.

Measurement conditions for temperature characteristics K7.

Applied voltage and Temperature step

Step	C	Applying Voltage	Temperature°C
1	C0	No bias	Reference Temp.
2	—	50% of Rated voltage	Reference Temp.
3	C1		Min. Operating Temp.
4	C2		Reference Temp.
5	C1		Max. Operating Temp.

$$\Delta C/C(\%) = (C1 - C2)/C0 \times 100$$

C0:Capacitance value at step 1

C1:Capacitance value from step 3 to 5

C2:Capacitance value at step 4

⑤ Voltage Code

CODE	Rated Voltage	CODE	Rated Voltage
0E	2.5Vdc	1E	25Vdc
0G	4Vdc	1V	35Vdc
0J	6.3Vdc	1H	50Vdc
1A	10Vdc	2A	100Vdc
1C	16Vdc		

⑥ Capacitance Code

Capacitance expressed in pF.
 Two significant digits plus number of zeros.
 For Values < 10pF, Letter R denotes decimal point,

(Example)

CODE	Capacitance	CODE	Capacitance
R50	0.5pF	103	10000pF
1R0	1pF	104	0.1μF
100	10pF	105	1μF
101	100pF	106	10μF
102	1000pF	107	100μF

⑦ Tolerance Code

Temperature Compensation Type(CG/CH)	
CODE	Tolerance
A*	±0.05pF
B	±0.1pF
C	±0.25pF
D	±0.5pF
G*	±2%
J	±5%
K	±10%

* : Option

High Dielectric Constant Type (R5/S6/T6/R7/K7/S7/T7)	
CODE	Tolerance
J*	±5%
K	±10%
M	±20%

* : Option

⑧ Packaging Code

CODE	Size Code	Material	Width	Pitch	Reel size
T	15 to 31	Paper	8mm	4mm	φ180
H	02 to 05	Paper	8mm	2mm	
Q	03	Paper	8mm	1mm	
U	21 to 32	Plastic	8mm	4mm	
P	02	Plastic	4mm	1mm	
M	15 / 21	Paper	8mm	4mm	φ330
N	02 to 05	Paper	8mm	2mm	
W	03	Paper	8mm	1mm	
L	21 to 32	Plastic	8mm	4mm	

Dimension

■KGM/KGT/KGU/KAM Series (Two Terminal Capacitors)

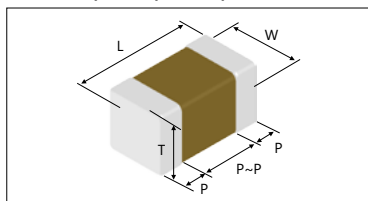

■Packaging Code

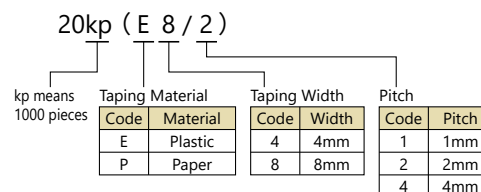

Size	Code		Thickness Code	Dimension (mm)						Quantity per reel	
	EIA	JIS		L	W	T	P min.	P max.	P ~ P min.	φ180 Reel	φ330 Reel
02	01005	0402	A	0.4±0.02	0.2±0.02	0.2±0.02	0.07	0.14	0.13	40kp(E4/1) 20kp(P8/2)	— 80kp(P8/2)
03	0201	0603	Y	0.6±0.03	0.3±0.03	0.22 max.	0.1	0.2	0.2	30kp(P8/1) 15kp(P8/2)	150kp(P8/1) 50kp(P8/2)
			A			0.3±0.03					
			B	0.6±0.05	0.3±0.05	0.22 max.	0.13	0.23	0.19	15kp(P8/2)	50kp(P8/2)
			Y*	0.6±0.09	0.3±0.09	0.3±0.09					
			C			0.5±0.05					
D	0.33 max.										
05	0402	1005	Y	1.0±0.05	0.5±0.05	0.22 max.	0.15	0.35	0.3	10kp(P8/2)	50kp(P8/2)
			A			0.33 max.					
			X	1.0±0.1	0.5±0.05	0.5±0.05				10kp(P8/2)	50kp(P8/2)
			B	1.0±0.15	0.5±0.15	0.5±0.15					
			Y*	1.0±0.2	0.5±0.2	0.33 max.				10kp(P8/2)	50kp(P8/2)
			Z			0.5 max.					
			A*			0.55 max.				10kp(P8/2)	50kp(P8/2)
			C			0.5±0.2					
			D	0.8 max.	10kp(P8/2)	30kp(P8/2)					
			15	0603	1608	A				1.6±0.1	0.8±0.1
C	1.6±0.2	0.8±0.2				0.8±0.2					
21	0805	2012	C	2.0±0.2	1.25±0.2	0.95 max.	0.2	0.75	0.7	4kp(P8/4)	10kp(P8/4)
			A			1.25±0.2					
31	1206	3216	L	3.2±0.2	1.6±0.2	0.95 max.	0.3	0.85	1.4	4kp(P8/4)	—
			F			1.6±0.15					
			A	3.2±0.2	1.6±0.2	1.6±0.2				2.5kp(E8/4)	5kp(E8/4)
			H	3.2±0.3	1.6±0.3	1.6±0.3					
32	1210	3225	A	3.2±0.3	2.5±0.2	2.5±0.2	0.3	1.0	1.4	1kp(E8/4)	4kp(E8/4)

※ If there is a "*" in the thickness code, thickness (T- dimension) is the same but the L/W dimension are different. Please refer to the parts number list for details.

■KGN Series (Three Terminal Capacitors)

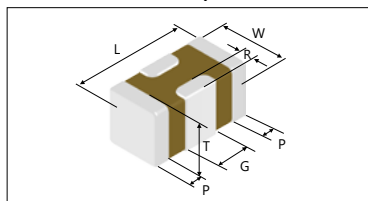

Size	Code		Thickness Code	Dimension (mm)						Quantity per reel	
	EIA	JIS		L	W	T	G	P	R	φ180 Reel	φ330 Reel
KGN 05	0402	1005	Z	1.0±0.1	0.5±0.2	0.5 max.	0.3±0.1	0.15±0.1	≥0.05	10kp(P8/2)	—
			B	1.0±0.15	0.5±0.15	0.5±0.15					
			C	1.0±0.2	0.5±0.2	0.5±0.2					

■ Features

We offer a diverse product line ranging from ultra-compact (0.4×0.2mm) to large (3.2×2.5mm) components configured for a variety of temperature characteristics, rated voltages, and packages. We offer the choice and flexibility for almost any applications.

■ Applications

This standard type is ideal for use in a wide range of applications, from commercial to industrial equipment.

Temperature Compensation Dielectric

● Capacitance chart ■ Standard Spec. 1

Capacitance	1R0	1R5	2R0	3R0	4R0	5R0	6R0	7R0	8R0	9R0	100	120	150	180	220	270	330	390	470	560	680	820	101	121	151	181	221	
Size/Voltage(Vdc)	1pF	1.5pF	2pF	3pF	4pF	5pF	6pF	7pF	8pF	9pF	10pF	12pF	15pF	18pF	22pF	27pF	33pF	39pF	47pF	56pF	68pF	82pF	100pF	120pF	150pF	180pF	220pF	
KGM02 (01005)	16	25																										

Please contact for capacitance value other than standard.

Please refer to [here](#) for the test method and specifications of Standard Specification 1.

The code in the capacity range table means product thickness (T-dimension). For details of the above lineup, please refer to the parts number list below.

(Example) In case of "A" for KGM02;
T: 0.2±0.02mm

Parts number list General KGM02 Series Temperature Characteristic: CA: CG/CH Tolerance □: B: ±0.1 pF/ C: ±0.25 pF/ D: ± 0.5 pF/ J: ± 5%/ K: ±10%

Thickness code	Part Number	Capacitance	Tolerance □	Voltage [V]	Dimension [mm]			Packaging: #							
					L	W	T	Φ180				Φ330			
								code	QTY	code	QTY	code	QTY	code	QTY
A	KGM02ACΔ1E1R0□#	1pF	B/C	25	0.4±0.02	0.2±0.02	0.2±0.02	H	20kp	P	40kp	N	80kp	—	—
A	KGM02ACΔ1E1R5□#	1.5pF	B/C	25	0.4±0.02	0.2±0.02	0.2±0.02	H	20kp	P	40kp	N	80kp	—	—
A	KGM02ACΔ1E2R0□#	2pF	B/C	25	0.4±0.02	0.2±0.02	0.2±0.02	H	20kp	P	40kp	N	80kp	—	—
A	KGM02ACΔ1E3R0□#	3pF	B/C	25	0.4±0.02	0.2±0.02	0.2±0.02	H	20kp	P	40kp	N	80kp	—	—
A	KGM02ACΔ1E4R0□#	4pF	B/C	25	0.4±0.02	0.2±0.02	0.2±0.02	H	20kp	P	40kp	N	80kp	—	—
A	KGM02ACΔ1E5R0□#	5pF	B/C	25	0.4±0.02	0.2±0.02	0.2±0.02	H	20kp	P	40kp	N	80kp	—	—
A	KGM02ACΔ1E6R0□#	6pF	C/D	25	0.4±0.02	0.2±0.02	0.2±0.02	H	20kp	P	40kp	N	80kp	—	—
A	KGM02ACΔ1E7R0□#	7pF	C/D	25	0.4±0.02	0.2±0.02	0.2±0.02	H	20kp	P	40kp	N	80kp	—	—
A	KGM02ACΔ1E8R0□#	8pF	C/D	25	0.4±0.02	0.2±0.02	0.2±0.02	H	20kp	P	40kp	N	80kp	—	—
A	KGM02ACΔ1E9R0□#	9pF	C/D	25	0.4±0.02	0.2±0.02	0.2±0.02	H	20kp	P	40kp	N	80kp	—	—
A	KGM02ACΔ1E100□#	10pF	J/K	25	0.4±0.02	0.2±0.02	0.2±0.02	H	20kp	P	40kp	N	80kp	—	—
A	KGM02ACΔ1E120□#	12pF	J/K	25	0.4±0.02	0.2±0.02	0.2±0.02	H	20kp	P	40kp	N	80kp	—	—
A	KGM02ACΔ1E150□#	15pF	J/K	25	0.4±0.02	0.2±0.02	0.2±0.02	H	20kp	P	40kp	N	80kp	—	—
A	KGM02ACΔ1E180□#	18pF	J/K	25	0.4±0.02	0.2±0.02	0.2±0.02	H	20kp	P	40kp	N	80kp	—	—
A	KGM02ACΔ1E220□#	22pF	J/K	25	0.4±0.02	0.2±0.02	0.2±0.02	H	20kp	P	40kp	N	80kp	—	—
A	KGM02ACΔ1C270□#	27pF	J/K	16	0.4±0.02	0.2±0.02	0.2±0.02	H	20kp	P	40kp	N	80kp	—	—
A	KGM02ACΔ1C330□#	33pF	J/K	16	0.4±0.02	0.2±0.02	0.2±0.02	H	20kp	P	40kp	N	80kp	—	—
A	KGM02ACΔ1C390□#	39pF	J/K	16	0.4±0.02	0.2±0.02	0.2±0.02	H	20kp	P	40kp	N	80kp	—	—
A	KGM02ACΔ1C470□#	47pF	J/K	16	0.4±0.02	0.2±0.02	0.2±0.02	H	20kp	P	40kp	N	80kp	—	—
A	KGM02ACΔ1C560□#	56pF	J/K	16	0.4±0.02	0.2±0.02	0.2±0.02	H	20kp	P	40kp	N	80kp	—	—
A	KGM02ACΔ1C680□#	68pF	J/K	16	0.4±0.02	0.2±0.02	0.2±0.02	H	20kp	P	40kp	N	80kp	—	—
A	KGM02ACΔ1C820□#	82pF	J/K	16	0.4±0.02	0.2±0.02	0.2±0.02	H	20kp	P	40kp	N	80kp	—	—
A	KGM02ACΔ1C101□#	100pF	J/K	16	0.4±0.02	0.2±0.02	0.2±0.02	H	20kp	P	40kp	N	80kp	—	—
A	KGM02ACΔ1C221□#	220pF	J/K	16	0.4±0.02	0.2±0.02	0.2±0.02	H	20kp	P	40kp	N	80kp	—	—

Multilayer Ceramic Chip Capacitors



General

KGM Series

R5 Dielectric

● Capacitance chart ■ Standard Spec.1 ■ Standard Spec.2 ▨ Optional Spec.

		R5																					
Capacitance		101	151	221	331	471	681	102	152	222	332	472	682	103	153	223	333	473	683	104	224	474	
Size/Voltage(Vdc)		100pF	150pF	220pF	330pF	470pF	680pF	1000pF	1500pF	2200pF	3300pF	4700pF	6800pF	10000pF	15000pF	22000pF	33000pF	47000pF	68000pF	0.1μF	0.22μF	0.47μF	
KGM02 (01005)	6.3																						
	10																						
	16																						

		R5															
Capacitance		223	333	473	683	104	224	474	105	225	475	106	156	226	476	107	
Size/Voltage(Vdc)		22000pF	33000pF	47000pF	68000pF	0.1μF	0.22μF	0.47μF	1μF	2.2μF	4.7μF	10μF	15μF	22μF	47μF	100μF	
KGM03 (0201)	4																
	6.3																
	10	A7	A7	A7	A7	A7		A8	B8	B8	C8	D9					
	16																
	25																
KGM05 (0402)	4																
	6.3																
	10																
	16																
	25																
KGM15 (0603)	4																
	6.3																
	10																
	16																
	25																
KGM21 (0805)	4																
	6.3																
	10																
	16																
	25																
KGM31 (1206)	16																
	25																
	50																
	100																
KGM32 (1210)	16																
	25																
	35																
	50																

Please contact for capacitance value other than standard.

Please refer to [here](#) for the test method and specifications of Standard Specification 1.

Please refer to [here](#) for the test method and specifications of Standard Specification 2.

Please refer to [here](#) of the parts number list for "*".

The code in the capacity range table means product thickness (T-dimension) and Tan delta.

For details about T dimensions, please refer to the Dimension section in the parts number list below.

For Tan delta, please refer to the list on the right.

(Example) In case of "A7" for KGM03;

T: 0.3±0.03mm, Tanδ: 10.0% max.

Tan δ Code	Tan δ
3	5.0% max.
7	10.0% max.
8	12.5% max.
9	15.0% max.
10	20.0% max.

Parts number list General KGM02 Series Temperature Characteristic: R5 Tolerance □: K: ±10%/ M: ±20%

Thickness code	Part Number	Capacitance	Tolerance □	Voltage [V]	Dimension [mm]			Packaging: #							
					L	W	T	Φ180				Φ330			
								code	QTY	code	QTY	code	QTY	code	QTY
A8	KGM02AR51C101□#	100pF	K/M	16	0.4±0.02	0.2±0.02	0.2±0.02	H	20kp	P	40kp	N	80kp	-	-
A8	KGM02AR51C151□#	150pF	K/M	16	0.4±0.02	0.2±0.02	0.2±0.02	H	20kp	P	40kp	N	80kp	-	-
A8	KGM02AR51C221□#	220pF	K/M	16	0.4±0.02	0.2±0.02	0.2±0.02	H	20kp	P	40kp	N	80kp	-	-
A8	KGM02AR51C331□#	330pF	K/M	16	0.4±0.02	0.2±0.02	0.2±0.02	H	20kp	P	40kp	N	80kp	-	-
A8	KGM02AR51C471□#	470pF	K/M	16	0.4±0.02	0.2±0.02	0.2±0.02	H	20kp	P	40kp	N	80kp	-	-
A8	KGM02AR51C681□#	680pF	K/M	16	0.4±0.02	0.2±0.02	0.2±0.02	H	20kp	P	40kp	N	80kp	-	-
A8	KGM02AR51C102□#	1000pF	K/M	16	0.4±0.02	0.2±0.02	0.2±0.02	H	20kp	P	40kp	N	80kp	-	-
A8	KGM02AR51C152□#	1500pF	K/M	16	0.4±0.02	0.2±0.02	0.2±0.02	H	20kp	P	40kp	N	80kp	-	-
A8	KGM02AR51C222□#	2200pF	K/M	16	0.4±0.02	0.2±0.02	0.2±0.02	H	20kp	P	40kp	N	80kp	-	-
A8	KGM02AR51C332□#	3300pF	K/M	16	0.4±0.02	0.2±0.02	0.2±0.02	H	20kp	P	40kp	N	80kp	-	-
A8	KGM02AR51C472□#	4700pF	K/M	16	0.4±0.02	0.2±0.02	0.2±0.02	H	20kp	P	40kp	N	80kp	-	-
A8	KGM02AR51C682□#	6800pF	K/M	16	0.4±0.02	0.2±0.02	0.2±0.02	H	20kp	P	40kp	N	80kp	-	-
A8	KGM02AR51C103□#	10000pF	K/M	16	0.4±0.02	0.2±0.02	0.2±0.02	H	20kp	P	40kp	N	80kp	-	-
A8	KGM02AR51A104□#	0.1μF	K/M	10	0.4±0.02	0.2±0.02	0.2±0.02	H	20kp	P	40kp	N	80kp	-	-
A8	KGM02AR50J153□#	15000pF	K/M	6.3	0.4±0.02	0.2±0.02	0.2±0.02	H	20kp	P	40kp	N	80kp	-	-
A8	KGM02AR50J223□#	22000pF	K/M	6.3	0.4±0.02	0.2±0.02	0.2±0.02	H	20kp	P	40kp	N	80kp	-	-
A8	KGM02AR50J333□#	33000pF	K/M	6.3	0.4±0.02	0.2±0.02	0.2±0.02	H	20kp	P	40kp	N	80kp	-	-
A8	KGM02AR50J473□#	47000pF	K/M	6.3	0.4±0.02	0.2±0.02	0.2±0.02	H	20kp	P	40kp	N	80kp	-	-
A8	KGM02AR50J683□#	68000pF	K/M	6.3	0.4±0.02	0.2±0.02	0.2±0.02	H	20kp	P	40kp	N	80kp	-	-
A8	KGM02AR50J104□#	0.1μF	K/M	6.3	0.4±0.02	0.2±0.02	0.2±0.02	H	20kp	P	40kp	N	80kp	-	-
A8	KGM02AR50J224□#	0.22μF	K/M	6.3	0.4±0.02	0.2±0.02	0.2±0.02	H	20kp	P	40kp	N	80kp	-	-
A8	KGM02AR50J474M#	0.47μF	M	6.3	0.4±0.02	0.2±0.02	0.2±0.02	H	20kp	P	40kp	N	80kp	-	-

Multilayer Ceramic Chip Capacitors



General

KGM Series



Parts number list General KGM03~32 Series Temperature Characteristic: R5 Tolerance □: K: ±10%/ M: ± 20%

Thickness code	Part Number	Capacitance	Tolerance □	Voltage [V]	Dimension [mm]			Packaging: #							
								Φ180			Φ330				
					L	W	T	code	QTY	code	QTY	code	QTY	code	QTY
C8	KGM03CR51E224□#	0.22μF	K/M	25	0.6±0.09	0.3±0.09	0.3±0.09	H	15kp	—	—	N	50kp	—	—
C8	KGM03CR51C224□#	0.22μF	K/M	16	0.6±0.09	0.3±0.09	0.3±0.09	H	15kp	—	—	N	50kp	—	—
C10	KGM03CR51C105□#	1μF	K/M	16	0.6±0.09	0.3±0.09	0.3±0.09	H	15kp	—	—	N	50kp	—	—
A7	KGM03AR51A223□#	22000pF	K/M	10	0.6±0.03	0.3±0.03	0.3±0.03	H	15kp	Q	30kp	N	50kp	W	150kp
A7	KGM03AR51A333□#	33000pF	K/M	10	0.6±0.03	0.3±0.03	0.3±0.03	H	15kp	Q	30kp	N	50kp	W	150kp
A7	KGM03AR51A473□#	47000pF	K/M	10	0.6±0.03	0.3±0.03	0.3±0.03	H	15kp	Q	30kp	N	50kp	W	150kp
A7	KGM03AR51A683□#	68000pF	K/M	10	0.6±0.03	0.3±0.03	0.3±0.03	H	15kp	Q	30kp	N	50kp	W	150kp
A7	KGM03AR51A104□#	0.1μF	K/M	10	0.6±0.03	0.3±0.03	0.3±0.03	H	15kp	Q	30kp	N	50kp	W	150kp
A7	KGM03AR51A224□#	0.22μF	K/M	10	0.6±0.03	0.3±0.03	0.3±0.03	H	15kp	Q	30kp	N	50kp	W	150kp
C10	KGM03CR51A105□#	1μF	K/M	10	0.6±0.09	0.3±0.09	0.3±0.09	H	15kp	—	—	N	50kp	—	—
B8	KGM03BR51A105M#	1μF	M	10	0.6±0.05	0.3±0.05	0.3±0.05	H	15kp	Q	30kp	N	50kp	W	150kp
C9	KGM03CR51A225□#	2.2μF	K/M	10	0.6±0.09	0.3±0.09	0.3±0.09	H	15kp	—	—	N	50kp	—	—
A8	KGM03AR50J474□#	0.47μF	K/M	6.3	0.6±0.03	0.3±0.03	0.3±0.03	H	15kp	Q	30kp	N	50kp	W	150kp
B8	KGM03BR50J105□#	1μF	K/M	6.3	0.6±0.05	0.3±0.05	0.3±0.05	H	15kp	Q	30kp	N	50kp	W	150kp
C8	KGM03CR50J225□#	2.2μF	K/M	6.3	0.6±0.09	0.3±0.09	0.3±0.09	H	15kp	—	—	N	50kp	—	—
B8	KGM03BR50J225M#	2.2μF	M	6.3	0.6±0.05	0.3±0.05	0.3±0.05	H	15kp	Q	30kp	N	50kp	W	150kp
D9	KGM03DR50J475MH	4.7μF	M	6.3	0.6±0.09	0.3±0.09	0.5±0.05	H	10kp	—	—	—	—	—	—
C8	KGM03CR50G475M#	4.7μF	M	4	0.6±0.09	0.3±0.09	0.3±0.09	H	15kp	—	—	N	50kp	—	—
A7	KGM05AR51V105□#	1μF	K/M	35	1.0±0.05	0.5±0.05	0.5±0.05	H	10kp	—	—	N	50kp	—	—
C8	KGM05CR51V225M#	2.2μF	M	35	1.0±0.2	0.5±0.2	0.5±0.2	H	10kp	—	—	N	40kp	—	—
A3	KGM05AR51E104□#	0.1μF	K/M	25	1.0±0.05	0.5±0.05	0.5±0.05	H	10kp	—	—	N	50kp	—	—
A7	KGM05AR51E105□#	1μF	K/M	25	1.0±0.05	0.5±0.05	0.5±0.05	H	10kp	—	—	N	50kp	—	—
C8	KGM05CR51E225M#	2.2μF	M	25	1.0±0.2	0.5±0.2	0.5±0.2	H	10kp	—	—	N	40kp	—	—
A*8	KGM05AR51E225□#	2.2μF	K/M	25	1.0±0.2	0.5±0.2	0.55max.	H	10kp	—	—	N	50kp	—	—
C8	KGM05CR51E475M#	4.7μF	M	25	1.0±0.2	0.5±0.2	0.5±0.2	H	10kp	—	—	N	40kp	—	—
A8	KGM05AR51C474□#	0.47μF	K/M	16	1.0±0.05	0.5±0.05	0.5±0.05	H	10kp	—	—	N	50kp	—	—
A7	KGM05AR51C105□#	1μF	K/M	16	1.0±0.05	0.5±0.05	0.5±0.05	H	10kp	—	—	N	50kp	—	—
A8	KGM05AR51C225□#	2.2μF	K/M	16	1.0±0.05	0.5±0.05	0.5±0.05	H	10kp	—	—	N	50kp	—	—
C8	KGM05CR51C475M#	4.7μF	M	16	1.0±0.2	0.5±0.2	0.5±0.2	H	10kp	—	—	N	40kp	—	—
A8	KGM05AR51A474□#	0.47μF	K/M	10	1.0±0.05	0.5±0.05	0.5±0.05	H	10kp	—	—	N	50kp	—	—
A7	KGM05AR51A105□#	1μF	K/M	10	1.0±0.05	0.5±0.05	0.5±0.05	H	10kp	—	—	N	50kp	—	—
A8	KGM05AR51A225□#	2.2μF	K/M	10	1.0±0.05	0.5±0.05	0.5±0.05	H	10kp	—	—	N	50kp	—	—
C8	KGM05CR51A475M#	4.7μF	M	10	1.0±0.2	0.5±0.2	0.5±0.2	H	10kp	—	—	N	40kp	—	—
B8	KGM05BR51A475M#	4.7μF	M	10	1.0±0.15	0.5±0.15	0.5±0.15	H	10kp	—	—	N	40kp	—	—
C8	KGM05CR51A106M#	10μF	M	10	1.0±0.2	0.5±0.2	0.5±0.2	H	10kp	—	—	N	40kp	—	—
A8	KGM05AR50J225□#	2.2μF	K/M	6.3	1.0±0.05	0.5±0.05	0.5±0.05	H	10kp	—	—	N	50kp	—	—
C8	KGM05CR50J106M#	10μF	M	6.3	1.0±0.2	0.5±0.2	0.5±0.2	H	10kp	—	—	N	40kp	—	—
B8	KGM05BR50J156M#	15μF	M	6.3	1.0±0.15	0.5±0.15	0.5±0.15	H	10kp	—	—	N	40kp	—	—
C8	KGM05CR50J226M#	22μF	M	6.3	1.0±0.2	0.5±0.2	0.5±0.2	H	10kp	—	—	N	40kp	—	—
D8	KGM05DR50J226M#	22μF	M	6.3	1.0±0.2	0.5±0.2	0.8max.	H	10kp	—	—	N	30kp	—	—
B8	KGM05BR50G156M#	15μF	M	4	1.0±0.15	0.5±0.15	0.5±0.15	H	10kp	—	—	N	40kp	—	—
C8	KGM05CR50G226M#	22μF	M	4	1.0±0.2	0.5±0.2	0.5±0.2	H	10kp	—	—	N	40kp	—	—
C8	KGM15CR51V475□#	4.7μF	K/M	35	1.6±0.2	0.8±0.2	0.8±0.2	T	4kp	—	—	M	10kp	—	—
C9	KGM15CR51V106M#	10μF	M	35	1.6±0.2	0.8±0.2	0.8±0.2	T	4kp	—	—	M	10kp	—	—
C8	KGM15CR51E475□#	4.7μF	K/M	25	1.6±0.2	0.8±0.2	0.8±0.2	T	4kp	—	—	M	10kp	—	—
C9	KGM15CR51E106□#	10μF	K/M	25	1.6±0.2	0.8±0.2	0.8±0.2	T	4kp	—	—	M	10kp	—	—
C8	KGM15CR51E226M#	22μF	M	25	1.6±0.2	0.8±0.2	0.8±0.2	T	4kp	—	—	M	10kp	—	—
C9	KGM15CR51C106□#	10μF	K/M	16	1.6±0.2	0.8±0.2	0.8±0.2	T	4kp	—	—	M	10kp	—	—
C8	KGM15CR51C226M#	22μF	M	16	1.6±0.2	0.8±0.2	0.8±0.2	T	4kp	—	—	M	10kp	—	—
C8	KGM15CR51A226M#	22μF	M	10	1.6±0.2	0.8±0.2	0.8±0.2	T	4kp	—	—	M	10kp	—	—
C8	KGM15CR50J476M#	47μF	M	6.3	1.6±0.2	0.8±0.2	0.8±0.2	T	4kp	—	—	M	10kp	—	—
C8	KGM15CR50G476M#	47μF	M	4	1.6±0.2	0.8±0.2	0.8±0.2	T	4kp	—	—	M	10kp	—	—
A8	KGM21AR51E226M#	22μF	M	25	2.0±0.2	1.25±0.2	1.25±0.2	U	3kp	—	—	L	10kp	—	—
A8	KGM21AR51C106□#	10μF	K/M	16	2.0±0.2	1.25±0.2	1.25±0.2	U	3kp	—	—	L	10kp	—	—
A8	KGM21AR51A226M#	22μF	M	10	2.0±0.2	1.25±0.2	1.25±0.2	U	3kp	—	—	L	10kp	—	—
A7	KGM21AR50J476M#	47μF	M	6.3	2.0±0.2	1.25±0.2	1.25±0.2	U	3kp	—	—	L	10kp	—	—
A8	KGM21AR50J107M#	100μF	M	6.3	2.0±0.2	1.25±0.2	1.25±0.2	U	3kp	—	—	L	10kp	—	—
A8	KGM21AR50G107M#	100μF	M	4	2.0±0.2	1.25±0.2	1.25±0.2	U	3kp	—	—	L	10kp	—	—
A3	KGM31AR52A225□#	2.2μF	K/M	100	3.2±0.2	1.6±0.2	1.6±0.2	U	2.5kp	—	—	L	5kp	—	—
A3	KGM31AR51H475□#	4.7μF	K/M	50	3.2±0.2	1.6±0.2	1.6±0.2	U	2.5kp	—	—	L	5kp	—	—
F3	KGM31FR51E225□#	2.2μF	K/M	25	3.2±0.2	1.6±0.15	1.6±0.15	U	2.5kp	—	—	L	5kp	—	—
A8	KGM31AR51E106□#	10μF	K/M	25	3.2±0.2	1.6±0.2	1.6±0.2	U	2.5kp	—	—	L	5kp	—	—
A8	KGM31AR51C226□#	22μF	K/M	16	3.2±0.2	1.6±0.2	1.6±0.2	U	2.5kp	—	—	L	5kp	—	—
A3	KGM32AR51H106□#	10μF	K/M	50	3.2±0.3	2.5±0.2	2.5±0.2	U	1kp	—	—	L	4kp	—	—
A3	KGM32AR51V106□#	10μF	K/M	35	3.2±0.3	2.5±0.2	2.5±0.2	U	1kp	—	—	L	4kp	—	—
A8	KGM32AR51E106□#	10μF	K/M	25	3.2±0.3	2.5±0.2	2.5±0.2	U	1kp	—	—	L	4kp	—	—
A3	KGM32AR51C106□#	10μF	K/M	16	3.2±0.3	2.5±0.2	2.5±0.2	U	1kp	—	—	L	4kp	—	—

S6/T6 Dielectric

● Capacitance chart ■ Standard Spec.2 ▨ Optional Spec.

		S6									
Capacitance Size/Voltage(Vdc)		104	224	474	105	225	475	106	226	476	107
		0.1μF	0.22μF	0.47μF	1μF	2.2μF	4.7μF	10μF	22μF	47μF	100μF
KGM03 (0201)	2.5						D9				
	4				C10						
	6.3				C10						
	10				C10						
KGM05 (0402)	4								D8		
	6.3				A8		B8/C8	C8			
	10			A8	A8		C8				
	16			A8	A*8						
	25			A8							
KGM15 (0603)	2.5									C8	C8
	4								C8	C8	
	6.3								C8	C8	
	10							C9	C8		
KGM21 (0805)	4									A7	A8
	6.3							A8			
	10							A8			
	16							A8			

		T6						
Capacitance Size/Voltage(Vdc)		104	224	474	105	225	475	106
		0.1μF	0.22μF	0.47μF	1μF	2.2μF	4.7μF	10μF
KGM03 (0201)	2.5				B8	C8		
	4					C8		
	6.3					C8		
	10		C8					

Please contact for capacitance value other than standard.

Please refer to [here](#) for the test method and specifications of Standard Specification 2

The code in the capacity range table means product thickness (T-dimension) and Tan delta. For details about T dimensions, please refer to the Dimension section in the parts number list below. For Tan delta, please refer to the list on the right.

(Example) In case of "C9" for KGM15;
T: 0.8±0.2mm, Tanδ: 15.0% max.

Tan δ Code	Tan δ
7	10.0% max.
8	12.5% max.
9	15.0% max.
10	20.0% max.

Parts number list General KGM03~21 Series Temperature Characteristic: S6 Tolerance □: K: ±10%/ M: ±20%

Thickness code	Part Number	Capacitance	Tolerance □	Voltage [V]	Dimension [mm]			Packaging: #							
					L	W	T	Φ180				Φ330			
								code	QTY	code	QTY	code	QTY	code	QTY
C10	KGM03CS61A105M#	1μF	M	10	0.6±0.09	0.3±0.09	0.3±0.09	H	15kp	-	-	N	50kp	-	-
C10	KGM03CS60J105M#	1μF	M	6.3	0.6±0.09	0.3±0.09	0.3±0.09	H	15kp	-	-	N	50kp	-	-
C10	KGM03CS60G105M#	1μF	M	4	0.6±0.09	0.3±0.09	0.3±0.09	H	15kp	-	-	N	50kp	-	-
D9	KGM03DS60E475MH	4.7μF	M	2.5	0.6±0.09	0.3±0.09	0.5±0.05	H	10kp	-	-	-	-	-	-
A8	KGM05AS61E105□#	1μF	K/M	25	1.0±0.05	0.5±0.05	0.5±0.05	H	10kp	-	-	N	50kp	-	-
A8	KGM05AS61C474M#	0.47μF	M	16	1.0±0.05	0.5±0.05	0.5±0.05	H	10kp	-	-	N	50kp	-	-
A*8	KGM05AS61C225M#	2.2μF	M	16	1.0±0.2	0.5±0.2	0.55max.	H	10kp	-	-	N	50kp	-	-
A8	KGM05AS61A474M#	0.47μF	M	10	1.0±0.05	0.5±0.05	0.5±0.05	H	10kp	-	-	N	50kp	-	-
A8	KGM05AS61A105M#	1μF	M	10	1.0±0.05	0.5±0.05	0.5±0.05	H	10kp	-	-	N	50kp	-	-
C8	KGM05CS61A475M#	4.7μF	M	10	1.0±0.2	0.5±0.2	0.5±0.2	H	10kp	-	-	N	40kp	-	-
C8	KGM05CS60J475M#	4.7μF	M	6.3	1.0±0.2	0.5±0.2	0.5±0.2	H	10kp	-	-	N	40kp	-	-
B8	KGM05BS60J475M#	4.7μF	M	6.3	1.0±0.15	0.5±0.15	0.5±0.15	H	10kp	-	-	N	40kp	-	-
C8	KGM05CS60J106M#	10μF	M	6.3	1.0±0.2	0.5±0.2	0.5±0.2	H	10kp	-	-	N	40kp	-	-
D8	KGM05DS60G226M#	22μF	M	4	1.0±0.2	0.5±0.2	0.8max.	H	10kp	-	-	N	30kp	-	-
C8	KGM15CS61C475□#	4.7μF	K/M	16	1.6±0.2	0.8±0.2	0.8±0.2	T	4kp	-	-	M	10kp	-	-
C9	KGM15CS61C106M#	10μF	M	16	1.6±0.2	0.8±0.2	0.8±0.2	T	4kp	-	-	M	10kp	-	-
C9	KGM15CS61A106□#	10μF	K/M	10	1.6±0.2	0.8±0.2	0.8±0.2	T	4kp	-	-	M	10kp	-	-
C8	KGM15CS61A226M#	22μF	M	10	1.6±0.2	0.8±0.2	0.8±0.2	T	4kp	-	-	M	10kp	-	-
C8	KGM15CS60J226M#	22μF	M	6.3	1.6±0.2	0.8±0.2	0.8±0.2	T	4kp	-	-	M	10kp	-	-
C8	KGM15CS60G226M#	22μF	M	4	1.6±0.2	0.8±0.2	0.8±0.2	T	4kp	-	-	M	10kp	-	-
C8	KGM15CS60G476M#	47μF	M	4	1.6±0.2	0.8±0.2	0.8±0.2	T	4kp	-	-	M	10kp	-	-
C8	KGM15CS60E476M#	47μF	M	2.5	1.6±0.2	0.8±0.2	0.8±0.2	T	4kp	-	-	M	10kp	-	-
A8	KGM21AS61C226M#	22μF	M	16	2.0±0.2	1.25±0.2	1.25±0.2	U	3kp	-	-	L	10kp	-	-
A8	KGM21AS61A226M#	22μF	M	10	2.0±0.2	1.25±0.2	1.25±0.2	U	3kp	-	-	L	10kp	-	-
A8	KGM21AS60J226M#	22μF	M	6.3	2.0±0.2	1.25±0.2	1.25±0.2	U	3kp	-	-	L	10kp	-	-
A7	KGM21AS60G476M#	47μF	M	4	2.0±0.2	1.25±0.2	1.25±0.2	U	3kp	-	-	L	10kp	-	-
A8	KGM21AS60G107M#	100μF	M	4	2.0±0.2	1.25±0.2	1.25±0.2	U	3kp	-	-	L	10kp	-	-

Parts number list General KGM03 Series Temperature Characteristics: T6 Tolerance □: K: ±10%/ M: ±20%

Thickness code	Part Number	Capacitance	Tolerance □	Voltage [V]	Dimension [mm]			Packaging: #							
					L	W	T	Φ180				Φ330			
								code	QTY	code	QTY	code	QTY	code	QTY
C8	KGM03CT61A224□#	0.22μF	K/M	10	0.6±0.09	0.3±0.09	0.3±0.09	H	15kp	-	-	N	50kp	-	-
C8	KGM03CT60G225M#	2.2μF	M	4	0.6±0.09	0.3±0.09	0.3±0.09	H	15kp	-	-	N	50kp	-	-
B8	KGM03BT60E105M#	1μF	M	2.5	0.6±0.05	0.3±0.05	0.3±0.05	H	15kp	Q	30kp	N	50kp	W	150kp
C8	KGM03CT60E225M#	2.2μF	M	2.5	0.6±0.09	0.3±0.09	0.3±0.09	H	15kp	-	-	N	50kp	-	-

Multilayer Ceramic Chip Capacitors



General

KGM Series

R7/K7 Dielectric

● Capacitance chart ■ Standard Spec.1 ■ Standard Spec.2

		R7									
Capacitance		101	151	221	331	471	681	102	152	222	
Size/Voltage(Vdc)		100pF	150pF	220pF	330pF	470pF	680pF	1000pF	1500pF	2200pF	
KGM02 (01005)	16	A8									

		K7							
Capacitance		104	224	474	105	225	475	106	226
Size/Voltage(Vdc)		0.1μF	0.22μF	0.47μF	1μF	2.2μF	4.7μF	10μF	22μF
KGM05 (0402)	10					B3			
KGM15 (0603)	10 16							C9	
KGM21 (0805)	10								A8
KGM31 (1206)	50 100					A3 A3	H3		

		R7							
Capacitance		104	224	474	105	225	475	106	226
Size/Voltage(Vdc)		0.1μF	0.22μF	0.47μF	1μF	2.2μF	4.7μF	10μF	22μF
KGM05 (0402)	6.3 25	A8		A8	A8				
KGM15 (0603)	25				A3				
KGM21 (0805)	6.3 16 25 50						A8 A7	A8	
KGM31 (1206)	6.3 10 16 25 50							A8 A5	
KGM32 (1210)	25 50					A3		A8 A3	

Tan δ Code	Tan δ
3	5.0% max.
5	7.5% max.
7	10.0% max.
8	12.5% max.
9	15.0% max.

Please contact for capacitance value other than standard.

Please refer to [here](#) for the test method and specifications of Standard Specification 1.

Please refer to [here](#) for the test method and specifications of Standard Specification 2.

The code in the capacity range table means product thickness (T-dimension) and Tan delta. For details about T dimensions, please refer to the Dimension section in the parts number list below. For Tan delta, please refer to the list on the right.

(Example) In case of "A8" for KGM02;
T: 0.8±0.2mm, Tanδ: 12.5% max.

Parts number list General KGM02~32 Series Temperature Characteristics: R7 Tolerance □: K: ±10%/ M: ±20%

Thickness code	Part Number	Capacitance	Tolerance □	Voltage [V]	Dimension [mm]			Packaging: #							
					L	W	T	Φ180				Φ330			
								code	QTY	code	QTY	code	QTY	code	QTY
A8	KGM02AR71C101□#	100pF	K/M	16	0.4±0.02	0.2±0.02	0.2±0.02	H	20kp	P	40kp	N	80kp	-	-
A8	KGM02AR71C151□#	150pF	K/M	16	0.4±0.02	0.2±0.02	0.2±0.02	H	20kp	P	40kp	N	80kp	-	-
A8	KGM02AR71C221□#	220pF	K/M	16	0.4±0.02	0.2±0.02	0.2±0.02	H	20kp	P	40kp	N	80kp	-	-
A8	KGM02AR71C331□#	330pF	K/M	16	0.4±0.02	0.2±0.02	0.2±0.02	H	20kp	P	40kp	N	80kp	-	-
A8	KGM02AR71C471□#	470pF	K/M	16	0.4±0.02	0.2±0.02	0.2±0.02	H	20kp	P	40kp	N	80kp	-	-
A8	KGM02AR71C681□#	680pF	K/M	16	0.4±0.02	0.2±0.02	0.2±0.02	H	20kp	P	40kp	N	80kp	-	-
A8	KGM02AR71C102□#	1000pF	K/M	16	0.4±0.02	0.2±0.02	0.2±0.02	H	20kp	P	40kp	N	80kp	-	-
A8	KGM02AR71C152□#	1500pF	K/M	16	0.4±0.02	0.2±0.02	0.2±0.02	H	20kp	P	40kp	N	80kp	-	-
A8	KGM02AR71C222□#	2200pF	K/M	16	0.4±0.02	0.2±0.02	0.2±0.02	H	20kp	P	40kp	N	80kp	-	-
A8	KGM05AR71E104□#	0.1μF	K/M	25	1.0±0.05	0.5±0.05	0.5±0.05	H	10kp	-	-	N	50kp	-	-
A8	KGM05AR70J474□#	0.47μF	K/M	6.3	1.0±0.05	0.5±0.05	0.5±0.05	H	10kp	-	-	N	50kp	-	-
A8	KGM05AR70J105□#	1μF	K/M	6.3	1.0±0.05	0.5±0.05	0.5±0.05	H	10kp	-	-	N	50kp	-	-
A3	KGM15AR71E105□#	1μF	K/M	25	1.6±0.1	0.8±0.1	0.8±0.1	T	4kp	-	-	M	10kp	-	-
A3	KGM21AR71H105□#	1μF	K/M	50	2.0±0.2	1.25±0.2	1.25±0.2	U	3kp	-	-	L	10kp	-	-
A7	KGM21AR71E475□#	4.7μF	K/M	25	2.0±0.2	1.25±0.2	1.25±0.2	U	3kp	-	-	L	10kp	-	-
A8	KGM21AR71C475□#	4.7μF	K/M	16	2.0±0.2	1.25±0.2	1.25±0.2	U	3kp	-	-	L	10kp	-	-
A8	KGM21AR71C106□#	10μF	K/M	16	2.0±0.2	1.25±0.2	1.25±0.2	U	3kp	-	-	L	10kp	-	-
A8	KGM21AR70J106□#	10μF	K/M	6.3	2.0±0.2	1.25±0.2	1.25±0.2	U	3kp	-	-	L	10kp	-	-
A3	KGM31AR71H475□#	4.7μF	K/M	50	3.2±0.2	1.6±0.2	1.6±0.2	U	2.5kp	-	-	L	5kp	-	-
A3	KGM31AR71E106□#	10μF	K/M	25	3.2±0.2	1.6±0.2	1.6±0.2	U	2.5kp	-	-	L	5kp	-	-
A8	KGM31AR71C106□#	10μF	K/M	16	3.2±0.2	1.6±0.2	1.6±0.2	U	2.5kp	-	-	L	5kp	-	-
A5	KGM31AR71A226□#	22μF	K/M	10	3.2±0.2	1.6±0.2	1.6±0.2	U	2.5kp	-	-	L	5kp	-	-
A8	KGM31AR70J226□#	22μF	K/M	6.3	3.2±0.2	1.6±0.2	1.6±0.2	U	2.5kp	-	-	L	5kp	-	-
A3	KGM32AR71H106□#	10μF	K/M	50	3.2±0.3	2.5±0.2	2.5±0.2	U	1kp	-	-	L	4kp	-	-
A8	KGM32AR71E106□#	10μF	K/M	25	3.2±0.3	2.5±0.2	2.5±0.2	U	1kp	-	-	L	4kp	-	-

Parts number list General KGM05~31 Series Temperature Characteristics: K7 Tolerance □: K: ±10%/ M: ±20%

Thickness code	Part Number	Capacitance	Tolerance □	Voltage [V]	Dimension [mm]			Packaging: #							
					L	W	T	Φ180				Φ330			
								code	QTY	code	QTY	code	QTY	code	QTY
B3	KGM05BK71A225□#	2.2μF	K/M	10	1.0±0.15	0.5±0.15	0.5±0.15	H	10kp	-	-	N	40kp	-	-
C8	KGM15CK71C475□#	4.7μF	K/M	16	1.6±0.2	0.8±0.2	0.8±0.2	T	4kp	-	-	M	10kp	-	-
C9	KGM15CK71A106M#	10μF	M	10	1.6±0.2	0.8±0.2	0.8±0.2	T	4kp	-	-	M	10kp	-	-
A8	KGM21AK71A226M#	22μF	M	10	2.0±0.2	1.25±0.2	1.25±0.2	U	3kp	-	-	L	10kp	-	-
A3	KGM31AK72A225□#	2.2μF	K/M	100	3.2±0.2	1.6±0.2	1.6±0.2	U	2.5kp	-	-	L	5kp	-	-
A3	KGM31AK71H225□#	2.2μF	K/M	50	3.2±0.2	1.6±0.2	1.6±0.2	U	2.5kp	-	-	L	5kp	-	-
H3	KGM31HK72A475□#	4.7μF	K/M	100	3.2±0.3	1.6±0.3	1.6±0.3	U	2kp	-	-	-	-	-	-

Multilayer Ceramic Chip Capacitors

General KGM Series

S7/T7 Dielectric

● Capacitance chart ■ Standard Spec.1 ■ Standard Spec.2 ▨ Optional Spec.

		S7					
Capacitance		104	224	474	105	225	475
Size/Voltage(Vdc)		0.1μF	0.22μF	0.47μF	1μF	2.2μF	4.7μF
KGM03 (0201)	6.3	▨ A7					
KGM05 (0402)	4				A8	B3	
	6.3				A8	B3	
KGM21 (0805)	100				A3		
	100				A3	H3	

		T7							
Capacitance		104	224	474	105	225	475	106	226
Size/Voltage(Vdc)		0.1μF	0.22μF	0.47μF	1μF	2.2μF	4.7μF	10μF	22μF
KGM03 (0201)	6.3				C8				
KGM05 (0402)	10						C8		
KGM15 (0603)	6.3						C8	C9	
	10						C8	C9	
KGM21 (0805)	6.3								A8
	10								A8

Please contact for capacitance value other than standard.

Please refer to [here](#) for the test method and specifications of Standard Specification 1.

Please refer to [here](#) for the test method and specifications of Standard Specification 2.

The code in the capacity range table means product thickness (T-dimension) and Tan delta. For details about T dimensions, please refer to the Dimension section in the parts number list below. For Tan delta, please refer to the list on the right.

(Example) In case of "C9" for KGM15;

T: 0.8±0.2mm, Tanδ: 15.0% max.

Tan δ Code	Tan δ
3	5.0% max.
5	7.5% max.
7	10.0% max.
8	12.5% max.
9	15.0% max.

Parts number list General KGM03~31 Series Temperature Characteristics: S7 Tolerance □: K: ±10%/ M: ±20%

Thickness code	Part Number	Capacitance	Tolerance □	Voltage [V]	Dimension [mm]			Packaging: #							
					L	W	T	Φ180				Φ330			
								code	QTY	code	QTY	code	QTY	code	QTY
A7	KGM03AS70J104□#	0.1μF	K/M	6.3	0.6±0.03	0.3±0.03	0.3±0.03	H	15kp	Q	30kp	N	50kp	W(W)	150kp
B3	KGM05BS71A225□#	2.2μF	K/M	10	1.0±0.15	0.5±0.15	0.5±0.15	H	10kp	-	-	N	40kp	-	-
A8	KGM05AS70J105□#	1μF	K/M	6.3	1.0±0.05	0.5±0.05	0.5±0.05	H	10kp	-	-	N	50kp	-	-
B3	KGM05BS70J225□#	2.2μF	K/M	6.3	1.0±0.15	0.5±0.15	0.5±0.15	H	10kp	-	-	N	40kp	-	-
A8	KGM05AS70G105□#	1μF	K/M	4	1.0±0.05	0.5±0.05	0.5±0.05	H	10kp	-	-	N	50kp	-	-
B3	KGM05BS70G225M#	2.2μF	M	4	1.0±0.15	0.5±0.15	0.5±0.15	H	10kp	-	-	N	40kp	-	-
A3	KGM21AS72A105□#	1μF	K/M	100	2.0±0.2	1.25±0.2	1.25±0.2	U	3kp	-	-	L	10kp	-	-
A3	KGM31AS72A225□#	2.2μF	K/M	100	3.2±0.2	1.6±0.2	1.6±0.2	U	2.5kp	-	-	L	5kp	-	-
H3	KGM31HS72A475□U	4.7μF	K/M	100	3.2±0.3	1.6±0.3	1.6±0.3	U	2kp	-	-	-	-	-	-

Parts number list General KGM03~21 Series Temperature Characteristics: T7 Tolerance □: K: ±10%/ M: ±20%

Thickness code	Part Number	Capacitance	Tolerance □	Voltage [V]	Dimension [mm]			Packaging: #							
					L	W	T	Φ180				Φ330			
								code	QTY	code	QTY	code	QTY	code	QTY
C8	KGM03CT70J105M#	1μF	M	6.3	0.6±0.09	0.3±0.09	0.3±0.09	H	15kp	-	-	N	50kp	-	-
C8	KGM05CT71A475M#	4.7μF	M	10	1.0±0.2	0.5±0.2	0.5±0.2	H	10kp	-	-	N	40kp	-	-
C8	KGM15CT71A475□#	4.7μF	K/M	10	1.6±0.2	0.8±0.2	0.8±0.2	T	4kp	-	-	M	10kp	-	-
C9	KGM15CT71A106M#	10μF	M	10	1.6±0.2	0.8±0.2	0.8±0.2	T	4kp	-	-	M	10kp	-	-
C8	KGM15CT70J475□#	4.7μF	K/M	6.3	1.6±0.2	0.8±0.2	0.8±0.2	T	4kp	-	-	M	10kp	-	-
C9	KGM15CT70J106M#	10μF	M	6.3	1.6±0.2	0.8±0.2	0.8±0.2	T	4kp	-	-	M	10kp	-	-
A8	KGM21AT71A226M#	22μF	M	10	2.0±0.2	1.25±0.2	1.25±0.2	U	3kp	-	-	L	10kp	-	-
A8	KGM21AT70J226M#	22μF	M	6.3	2.0±0.2	1.25±0.2	1.25±0.2	U	3kp	-	-	L	10kp	-	-

Test Conditions and Standards

Test Conditions and Specifications for Temperature Compensation Type (C) Characteristics KGM/KGT/KGU Series (Standard Spec.1)

Test Items		Test Conditions (Complies with JIS C5101/ IEC60384)	Specifications								
Capacitance(C)		<table border="1"> <thead> <tr> <th>Capacitance</th> <th>Frequency</th> <th>Volt</th> </tr> </thead> <tbody> <tr> <td>C ≤ 1000pF</td> <td>1MHz ± 10%</td> <td rowspan="2">0.5 to 5Vrms</td> </tr> <tr> <td>C > 1000pF</td> <td>1kHz ± 10%</td> </tr> </tbody> </table>	Capacitance	Frequency	Volt	C ≤ 1000pF	1MHz ± 10%	0.5 to 5Vrms	C > 1000pF	1kHz ± 10%	Within specified tolerance
Capacitance	Frequency		Volt								
C ≤ 1000pF	1MHz ± 10%	0.5 to 5Vrms									
C > 1000pF	1kHz ± 10%										
Q			C ≥ 30pF : Q ≥ 1000 C < 30pF : Q ≥ 400 + 20C								
Insulation Resistance		Measure after applying rated voltage for 1 minute in normal temperature and humidity. The charge and discharge current of the capacitor must not exceed 50mA.	Over 10000MΩ or 500MΩ · μF, whichever is less								
Dielectric Strength		Apply *3 times of the rated voltage for 1 to 5 seconds. *KGU02ACΔ1ER20-120 : twice The charge and discharge current of the capacitor must not exceed 50mA.	No problem observed								
Appearance		Microscope	No problem observed								
Termination Strength		Apply a sideward force of 5N to a PCB-mounted sample. note: 1N for 01005 size.	No problem observed								
Bending Strength		Glass epoxy PCB: Fulcrum spacing: 90mm, duration time 10 seconds.	No significant damage with 1mm bending.								
Vibration	Appearance	Vibration frequency: 10 to 55 (Hz) Amplitude: 1.5mm Sweeping condition: 10 → 55 → 10Hz / 1 minute in X, Y and Z directions: 2 hours each, 6 hours in total.	No problem observed								
	Capacitance		Within Tolerance								
	Q		C ≥ 30pF : Q ≥ 1000 C < 30pF : Q ≥ 400 + 20C								
Resistance to Solder Heat	Appearance	Soak the sample in 260°C ± 5°C solder for 10 ± 0.5 seconds, and measure after resting in normal temperature and humidity for 24 ± 2 hours. (Pre-heating conditions before soak)	No problem observed								
	Capacitance Variation		Within ± 2.5% or ± 0.25pF, whichever is larger								
	Q		C ≥ 30pF : Q ≥ 1000 C < 30pF : Q ≥ 400 + 20C								
	IR		Over 10000MΩ or 500MΩ · μF whichever is less								
	Dielectric strength		The charge and discharge current of the capacitor must not exceed 50mA for IR and dielectric strength measurement.	Resist without problem							
Solderability		Soaking condition	Solder coverage : 95% min.								
		<table border="1"> <thead> <tr> <th>Solder Type</th> <th>Temperature</th> <th>Time</th> </tr> </thead> <tbody> <tr> <td>Sn-3Ag-0.5Cu</td> <td>245 ± 5°C</td> <td>3 ± 0.5 sec.</td> </tr> </tbody> </table>		Solder Type	Temperature	Time	Sn-3Ag-0.5Cu	245 ± 5°C	3 ± 0.5 sec.		
Solder Type	Temperature	Time									
Sn-3Ag-0.5Cu	245 ± 5°C	3 ± 0.5 sec.									
Temperature Cycle	Appearance	(Cycle) Lowest operation temperature (30 min.) → Room temperature (3 min.) → Highest operation temperature (30 min.) → Room temperature (3 min.) After 5 cycles, measure after 24 ± 2 hours. The charge and discharge current of the capacitor must not exceed 50mA for IR and dielectric strength measurement.	No problem observed								
	Capacitance Variation		Within ± 2.5% or ± 0.25pF, whichever is larger								
	Q		C ≥ 30pF : Q ≥ 1000 C < 30pF : Q ≥ 400 + 20C								
	IR		Over 10000MΩ or 500MΩ · μF, whichever is less								
	Dielectric Strength		Resist without problem								
Load Humidity	Appearance	Apply the rated voltage for 500 + 12 / - 0 hours in the condition of 40°C ± 2°C and 90 to 95%RH, and measure after resting in normal temperature and humidity for 24 ± 2 hours. The charge and discharge current of the capacitor must not exceed 50mA for IR measurement.	No problem observed								
	Capacitance Variation		Within ± 7.5% or ± 0.75pF, whichever is larger								
	Q		C ≥ 30pF : Q ≥ 200 C < 30pF : Q ≥ 100 + 10C / 3								
	IR		Over 500MΩ or 25MΩ · μF, whichever is less								
Load Life	Appearance	Apply *twice the rated voltage in 125 ± 3°C for 1000 + 12 / - 0 hours, and measure after resting in normal temperature and humidity for 24 ± 2 hours. The charge and discharge current of the capacitor must not exceed 50mA for IR measurement. *Products listed below shall apply each indicated voltage.	No problem observed.								
	Capacitance Variation		Within ± 3% or ± 0.3pF, whichever is larger								
	Q		C ≥ 30pF : Q ≥ 350 10pF < C < 30pF : Q ≥ 275 + 5C / 2 C < 10pF : Q ≥ 200 + 10C								
	IR		Over 1000MΩ or 50MΩ · μF, whichever is less								

Voltage to be applied in the Load Life (Applied voltage is the multiple of the rated voltage)

Applied Voltage	Rated Voltage	Products
× 1.0	16V	KGM02ACΔ1C221
× 1.2	25V	KGU02ACΔ1ER20-120

Test Conditions and Standards

Test Conditions and Specifications for High Dielectric Type (R5, R7, S7) KGM/KGT Series (Standard Spec.1)

Test Items		Test Conditions (Complies with JIS C5101/ IEC60384)	Specifications												
Capacitance(C)		Measure after heat treatment	Within specified tolerance												
Tanδ		<table border="1"> <thead> <tr> <th>Capacitance</th> <th>Frequency</th> <th>Volt</th> </tr> </thead> <tbody> <tr> <td>C ≤ 10μF</td> <td>1kHz±10%</td> <td>1.0±0.2Vrms</td> </tr> <tr> <td></td> <td>*1kHz±10%</td> <td>0.5±0.2Vrms</td> </tr> <tr> <td>C > 10μF</td> <td>120Hz±10%</td> <td>0.5±0.2Vrms</td> </tr> </tbody> </table>	Capacitance	Frequency	Volt	C ≤ 10μF	1kHz±10%	1.0±0.2Vrms		*1kHz±10%	0.5±0.2Vrms	C > 10μF	120Hz±10%	0.5±0.2Vrms	Refer to capacitance chart
	Capacitance	Frequency	Volt												
C ≤ 10μF	1kHz±10%	1.0±0.2Vrms													
	*1kHz±10%	0.5±0.2Vrms													
C > 10μF	120Hz±10%	0.5±0.2Vrms													
	*KGM02AR50J104□# The charge and discharge current of the capacitor must not exceed 50mA.														
Insulation Resistance		Measure after applying rated voltage for 1 minute in normal temperature and humidity. The charge and discharge current of the capacitor must not exceed 50mA.	Over 10000MΩ or 500MΩ · μF, whichever is less												
Dielectric Strength		Apply *2.5 times of the rated voltage for 1 to 5 seconds. *KGM31AR52A225, KGM31AS72A225 : twice The charge and discharge current of the capacitor must not exceed 50mA.	No problem observed												
Appearance		Microscope	No problem observed												
Termination Strength		Apply a sideward force of 5N to a PCB-mounted sample. note : 2N for 0201 size, and 1N for 01005 size. Exclude KGT series with thickness of less than 0.66mm.	No problem observed												
Bending Strength		Glass epoxy PCB: Fulcrum spacing: 90mm, duration time 10 seconds. Exclude KGT series with thickness of less than 0.66mm.	No significant damage with 1mm bending												
Vibration	Appearance	Take the initial value after heat treatment.	No problem observed												
	Capacitance	Vibration frequency: 10 to 55 (Hz) Amplitude: 1.5mm	Within tolerance												
	Tanδ	Sweeping condition: 10→55→10Hz/ 1 minute in X, Y and Z directions: 2 hours each, 6 hours in total, then measure the sample after heat treatment.	Within tolerance												
Resistance to Solder Heat	Appearance	Take the initial value after heat treatment.	No problem observed												
	Capacitance Variation	Soak the sample in 260°C±5°C solder for 10±0.5 seconds, and measure after heat treatment. (Pre-heating conditions before soak)	Within±7.5%												
	Tanδ	<table border="1"> <thead> <tr> <th>Order</th> <th>Temperature</th> <th>Time</th> </tr> </thead> <tbody> <tr> <td>1</td> <td>80 to 100°C</td> <td>2 minutes</td> </tr> <tr> <td>2</td> <td>150 to 200°C</td> <td>2 minutes</td> </tr> </tbody> </table>	Order	Temperature	Time	1	80 to 100°C	2 minutes	2	150 to 200°C	2 minutes	Within tolerance			
	Order	Temperature	Time												
	1	80 to 100°C	2 minutes												
2	150 to 200°C	2 minutes													
IR		Over 10000MΩ or 500MΩ · μF, whichever is less													
Dielectric Strength	The charge and discharge current of the capacitor must not exceed 50mA for IR and dielectric strength measurement.	Resist without problem													
Solderability		Soaking condition	Solder coverage : 95% min.												
Temperature Cycle	Appearance	Take the initial value after heat treatment.	No problem observed												
	Capacitance Variation	(Cycle) Lowest operation temperature (30 min.)→ Room temperature (3 min.)→ Highest operation temperature(30 min.)→ Room temperature (3 min.)	Within±7.5%												
	Tanδ		Within tolerance												
	IR	After 5 cycles, measure after heat treatment. The charge and discharge current of the capacitor must not exceed 50mA for IR and dielectric strength measurement.	Over 10000MΩ or 500MΩ · μF, whichever is less												
	Dielectric Strength		Resist without problem												
Load Humidity	Appearance	Take the initial value after heat treatment.	No problem observed												
	Capacitance Variation	Apply rated voltage for 500+12/-0 hours in 40°C±2°C and 90 to 95%RH, and measure after heat treatment.	Within±12.5%												
	Tanδ	The charge and discharge current of the capacitor must not exceed 50mA for IR measurement.	200% max. of initial value												
	IR		Over 500MΩ or 25MΩ · μF, whichever is less												
Load Life	Appearance	Take the initial value after heat treatment.	No problem observed												
	Capacitance Variation	Apply *1.5 times the rated voltage at the highest operation temperature for 1000+12/-0 hours, and measure after heat treatment. The charge and discharge current of the capacitor must not exceed 50mA for IR measurement.	Within±12.5%												
	Tanδ		200% max. of initial value												
	IR	*Products listed below shall apply each indicated voltage.	Over 1000MΩ or 50MΩ · μF, whichever is less												
Heat treatment		Expose sample in the temperature of 150+0/-10°C for 1 hour and leave the sample in normal temperature and humidity for 24±2 hours.													

Voltage to be applied in the Load Life (Applied voltage is the multiple of the rated voltage)

Applied Voltage	Rated Voltage	Products
× 1.0	100V	KGM31AR52A225, KGM31AS72A225
	10V	KGM02AR51A104
	6.3V	KGM21AR50J107
	4V	KGM21AR50G107
× 1.3	6.3V	KGM02AR50J153-104, KGT03YR50J104

Please contact us for the optional specifications of the capacitance chart.

Test Conditions and Standards

Test Conditions and Specifications for High Dielectric Type (R5, S6, T6, R7, S7, T7, K7) KGM/KGT Series (Standard Spec.2)

Test Items	Test Conditions (Complies with JIS C5101/ IEC60384)	Specifications												
Capacitance(C)	Measure after heat treatment	Within specified tolerance												
Tanδ	<table border="1"> <thead> <tr> <th>Capacitance</th> <th>Frequency</th> <th>Volt</th> </tr> </thead> <tbody> <tr> <td>C ≤ 10μF</td> <td>1kHz±10%</td> <td>1.0±0.2Vrms</td> </tr> <tr> <td>C > 10μF</td> <td>*1kHz±10%</td> <td>0.5±0.2Vrms</td> </tr> <tr> <td></td> <td>120Hz±10%</td> <td>0.5±0.2Vrms</td> </tr> </tbody> </table> <p>* KGM02AR50J474, KGM03CR50J225, KGM03BR50J225, KGM03DR50J475, KGM03CR50G475, KGM05CR50J106, KGM05CS60J106, KGM03DS60E475, KGM03BT60E105, KGM05AR70J474, KGT03YR50J105, KGT05ZR50J106, KGT03YT60G105, KGT05YR50J475</p> <p>The charge and discharge current of the capacitor must not exceed 50mA.</p>	Capacitance	Frequency	Volt	C ≤ 10μF	1kHz±10%	1.0±0.2Vrms	C > 10μF	*1kHz±10%	0.5±0.2Vrms		120Hz±10%	0.5±0.2Vrms	Refer to capacitance chart
	Capacitance	Frequency	Volt											
C ≤ 10μF	1kHz±10%	1.0±0.2Vrms												
C > 10μF	*1kHz±10%	0.5±0.2Vrms												
	120Hz±10%	0.5±0.2Vrms												
Insulation Resistance	Measure after applying rated voltage for 1 minute in normal temperature and humidity. The charge and discharge current of the capacitor must not exceed 50mA.	Over 50MΩ · μF												
Dielectric Strength	Apply *2.5 times of the rated voltage for 1 to 5 seconds. *KGM21AS72A105, KGM31HS72A475: twice The charge and discharge current of the capacitor must not exceed 50mA.	No problem observed												
Appearance	Microscope	No problem observed												
Termination Strength	Apply a sideward force of 5N to a PCB-mounted sample. note : 2N for 0201 size, and 1N for 01005 size. Exclude KGT series with thickness of less than 0.66mm.	No problem observed												
Bending Strength	Glass epoxy PCB: Fulcrum spacing: 90mm, duration time 10 seconds. Exclude KGT series with thickness of less than 0.66mm.	No significant damage with 1mm bending												
Vibration	Appearance	No problem observed												
	Capacitance	Within tolerance												
	Tanδ	Within tolerance												
Resistance to Solder Heat	Appearance	No problem observed												
	Capacitance Variation	Within±7.5%												
	Tanδ	Within tolerance												
	IR	Over 50MΩ · μF												
	Dielectric Strength	Resist without problem												
Solderability	Soaking condition	Solder coverage : 95% min.												
	<table border="1"> <thead> <tr> <th>Solder Type</th> <th>Temperature</th> <th>Time</th> </tr> </thead> <tbody> <tr> <td>Sn-3Ag-0.5Cu</td> <td>245±5°C</td> <td>3±0.5 sec.</td> </tr> </tbody> </table>	Solder Type	Temperature	Time	Sn-3Ag-0.5Cu	245±5°C	3±0.5 sec.							
Solder Type	Temperature	Time												
Sn-3Ag-0.5Cu	245±5°C	3±0.5 sec.												
Temperature Cycle	Appearance	No problem observed												
	Capacitance Variation	Within±7.5%												
	Tanδ	Within tolerance												
	IR	Over 50MΩ · μF												
	Dielectric Strength	Resist without problem												
Load Humidity	Appearance	No problem observed												
	Capacitance Variation	Within±12.5%												
	Tanδ	200% max. of initial value												
	IR	Over 10MΩ · μF												
Load Life	Appearance	No problem observed												
	Capacitance Variation	Within±12.5%												
	Tanδ	200% max. of initial value												
	IR	Over 10MΩ · μF												
Heat treatment	Expose sample in the temperature of 150+0/ -10°C for 1 hour and leave the sample in normal temperature and humidity for 24±2 hours.													

Voltage to be applied in the Load Life (Applied voltage is the multiple of the rated voltage)

Applied Voltage	Rated Voltage	Products	Applied Voltage	Rated Voltage	Products
×1.2	6.3V	KGM03BR50J105	×1.5	16V	KGM05AR51C105, KGM15CR51C106
×1.3	10V	KGM03AR51A223-224		10V	KGM03CR51A105, KGM05AR51A474-225, KGM05CR51A475
	6.3V	KGM03AR50J474			KGM21AR51A226, KGM15CS61A106, KGM15CT71A475
×1.5	50V	KGM31AR71H475		6.3V	KGM05AR50J225, KGM05CS60J475, KGM21AS60J226
	25V	KGM15AR71E105, KGM21AR71E475			KGM05AR70J474, KGM05AR70J105, KGM05AS70J105
		KGM31AR71E106			KGM15CT70J106, KGM21AT70J226

Test Conditions and Standards

Substrate for Adhesion Strength Test, Vibration Test, Soldering Heat Resistance Test, Temperature Cycle Test, Load Humidity Test, High-Temperature with Loading Test.

(Unit: mm)

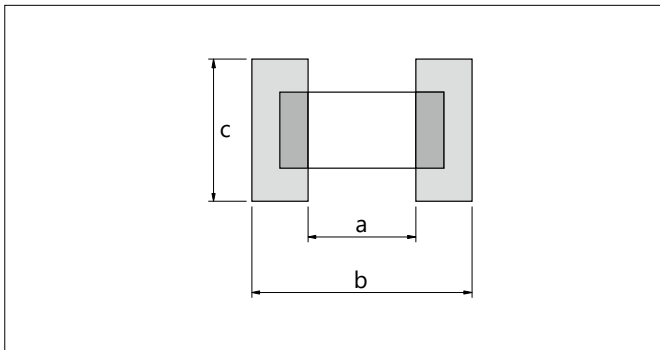

Size (EIA Code)	a	b	c
02 (01005)	0.15	0.5	0.2
03 (0201)	0.26	0.92	0.32
05 (0402)	0.4	1.4	0.5
15 (0603)	1.0	3.0	1.2
21 (0805)	1.2	4.0	1.65
31 (1206)	2.2	5.0	2.0
32 (1210)	2.2	5.0	2.9

Substrate for Bending Test

(Unit: mm)

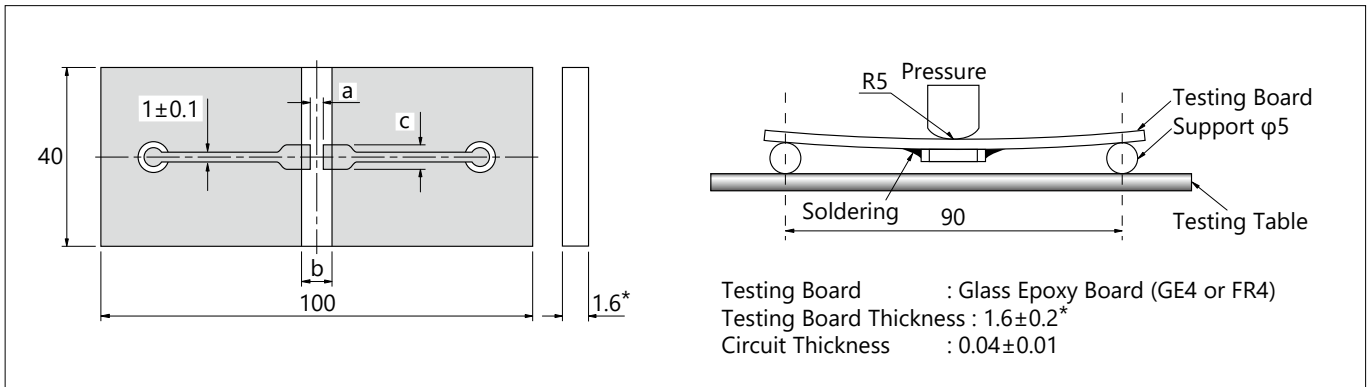

* 02, 03, 05 size 0.8 ± 0.1 mm

Structure

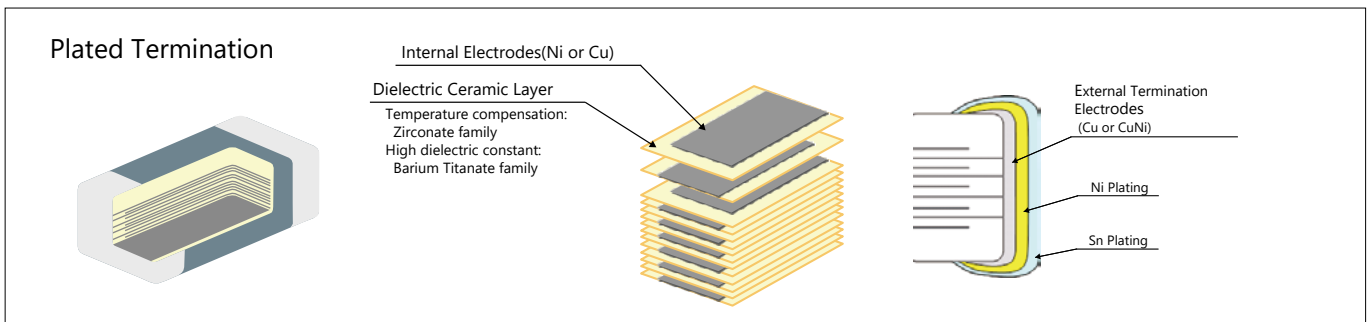

■ Certification status

<ISO>
 Acquired ISO 9001 quality management system certification.
 <IATF>
 Acquired IATF 16949 quality management system certification.

■ Production plant

Kagoshima Kokubu plant

Multilayer Ceramic Chip Capacitors

Packaging Options Tape and Reel

Reel

(Unit: mm)

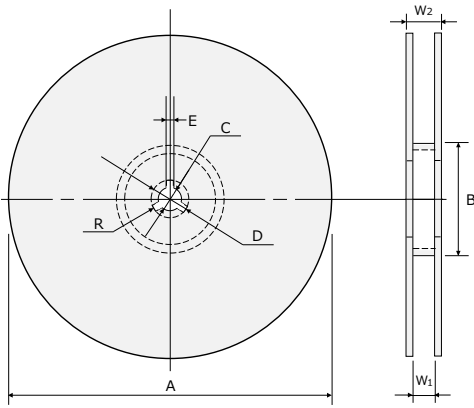

Code Reel	A	B	C	D
7-inch Reel (CODE: T, H, Q, U)	180 ⁺⁰ _{-2.0}	φ60 min.	13±0.5	21±0.8
7-inch Reel (CODE: P)	178±2.0			
13-inch Reel (CODE: L, M, N, W)	330±2.0			
Code Reel	E	W ₁	W ₂	R
7-inch Reel (CODE: T, H, Q, U)	2.0±0.5	10.5±1.5	16.5 max.	1.0
7-inch Reel (CODE: P)		4.35±0.3	6.95±1.0	
13-inch Reel (CODE: L, M, N, W)		9.5±1.0	16.5 max.	

Carrier Tape

(Unit: mm)

F=1mm (02 Size)

F=2mm (02, 03, 05 Size)

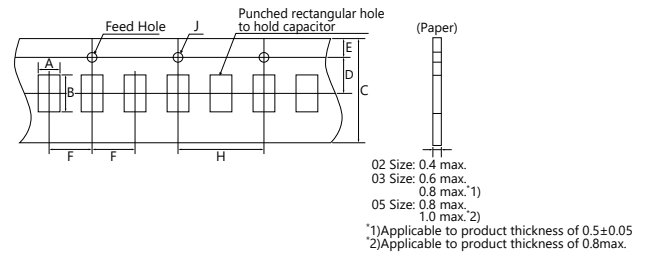
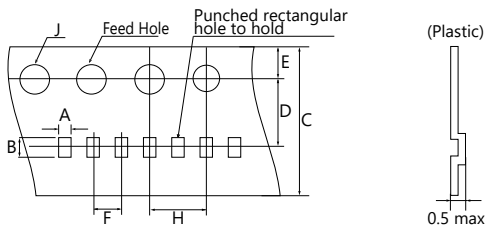

F=1mm (03 Size)

F=4mm (15, 21, 31, 32 Size)

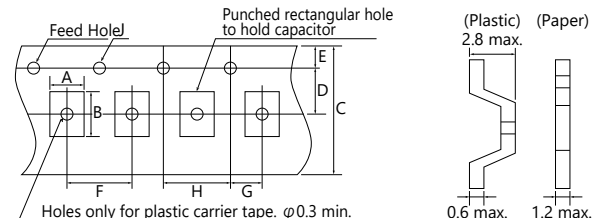
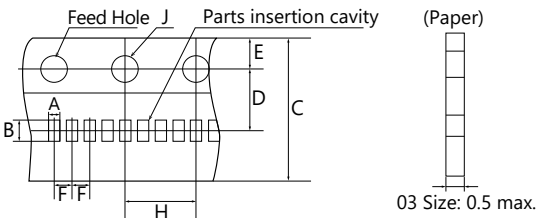

(Unit: mm)

Size (EIA Code)	A	B	C	D	E	F	G	H	J	Carrier Tape	
										Width	Material
02 (01005)*	0.24±0.02	0.44±0.02	4.0±0.08	1.8±0.02	0.9±0.05	1.0±0.02	—	2.0±0.04	0.8±0.04	4	Plastic
	0.25±0.03	0.45±0.03	8.0±0.3	3.5±0.05	1.75±0.1	2.0±0.05		4.0±0.1	1.5±0.1/-0	8	Paper
03 (0201)*	0.37±0.03	0.67±0.03	8.0+0.3/-0.1	3.5±0.05	1.75±0.1	1.0±0.05	—	4.0±0.05	1.5±0.1/-0	8	Paper
	0.39±0.03	0.69±0.03	8.0±0.3	3.5±0.05	1.75±0.1	2.0±0.05		4.0±0.1	1.5±0.1/-0		
	0.42±0.03	0.72±0.03	8.0±0.3	3.5±0.05	1.75±0.1	2.0±0.05		4.0±0.1	1.5±0.1/-0		
	0.44±0.05	0.74±0.05	8.0±0.3	3.5±0.05	1.75±0.1	2.0±0.05		4.0±0.1	1.5±0.1/-0		
05 (0402)*	0.65±0.1	1.15±0.1	8.0±0.3	3.5±0.05	1.75±0.1	2.0±0.05	—	4.0±0.1	1.5±0.1/-0	8	Paper
	0.75±0.1										
	0.8±0.1										
15 (0603)*	1.0±0.2	1.8±0.2	8.0±0.3	3.5±0.05	1.75±0.1	4.0±0.1	2.0±0.05	4.0±0.1	1.5±0.1/-0	8	Paper
	1.1±0.2	1.9±0.2	8.0±0.3	3.5±0.05	1.75±0.1	4.0±0.1	2.0±0.05	4.0±0.1	1.5±0.1/-0		
21 (0805)	1.5±0.2	2.3±0.2	8.0±0.3	3.5±0.05	1.75±0.1	4.0±0.1	2.0±0.05	4.0±0.1	1.5±0.1/-0	8	Plastic
										8	Paper
31 (1206)	2.0±0.2	3.6±0.2	8.0±0.3	3.5±0.05	1.75±0.1	4.0±0.1	2.0±0.05	4.0±0.1	1.5±0.1/-0	8	Paper
										8	Plastic
32 (1210)	2.9±0.2	3.6±0.2	8.0±0.3	3.5±0.05	1.75±0.1	4.0±0.1	2.0±0.05	4.0±0.1	1.5±0.1/-0	8	Plastic

* Option

Packaging Options

Detail of leader and trailer

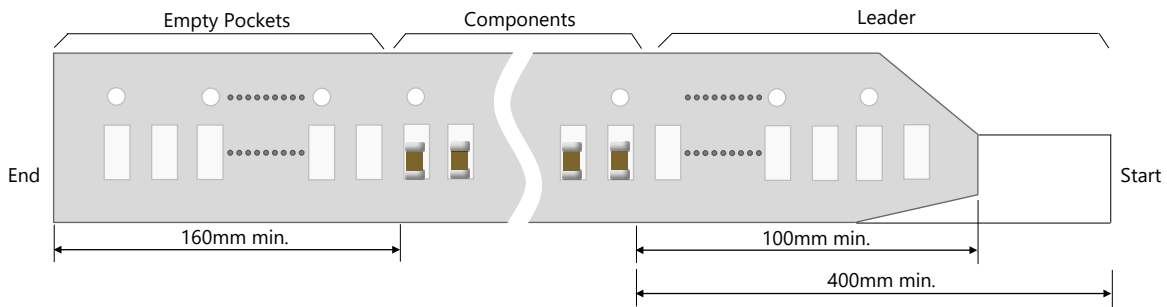

Adhesive tape

- 1) The exfoliative strength when peeling off the top tape from the carrier tape by the method of the following figure shall be *0.1 to 0.7N. *02 Size: 0.1 to 0.5N
- 2) When the top tape is peeled off, the adhesive stays on the top tape.
- 3) Chip capacitors will be in a state free without being stuck on the thermal adhesive tape.

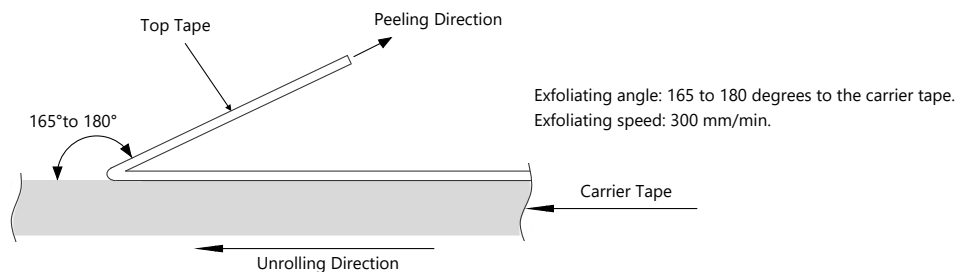

Carrier tape

- 1) Chip will not fall off from carrier tape or carrier tape will not be damaged by bending than within a radius of 25mm.
- 2) The chip are inserted continuously without any empty pocket.
- 3) Chip will not be mis-mounted because of too big clearance between components and cavity. Also the waste of carrier tape will not fill a nozzle hole of mounting machine.

Surface Mounting Information

Dimensions for recommended typical land

Since the amount of solder (size of fillet) to be used has direct influence on the capacitor after mounting, the sufficient consideration is necessary.

When the amounts of solder is too much, the stress that a capacitor receives becomes larger. It may become the cause of a crack in the capacitor. When the land design of printed wiring board is considered, it is necessary to set up the form and size of land pattern so that the amount of solder is suitable.

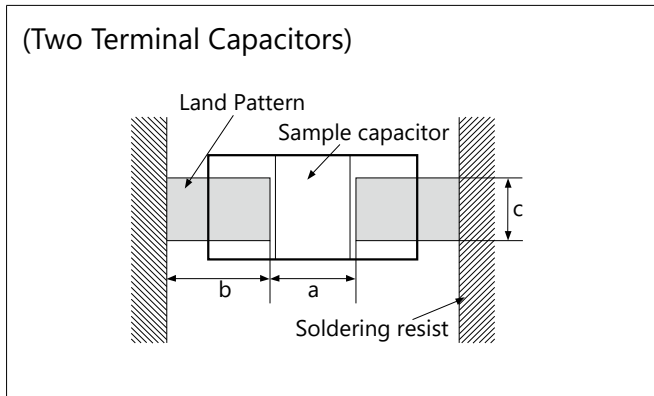

Two Terminal Capacitors

(Unit: mm)

Size (EIA Code)	Dimension		Recommended land dimensions		
	L	W	a	b	c
02 (01005)	0.4±0.02	0.2±0.02	0.13 to 0.2	0.12 to 0.18	0.2 to 0.23
03 (0201)	0.6±0.03	0.3±0.03	0.2 to 0.25	0.25 to 0.35	0.3 to 0.4
	0.6±0.05	0.3±0.05			
	0.6±0.09	0.3±0.09	0.23 to 0.3	0.25 to 0.35	0.3 to 0.45
05 (0402)	1.0±0.05	0.5±0.05	0.3 to 0.5	0.35 to 0.45	0.4 to 0.6
	1.0±0.15	0.5±0.15			
15 (0603)	1.6±0.1	0.8±0.1	0.7 to 1.0	0.8 to 1.0	0.6 to 0.9
	1.6±0.2	0.8±0.2	0.8 to 1.0	0.8 to 1.0	0.8 to 1.1
21 (0805)	2.0±0.2	1.25±0.2	1.0 to 1.3	1.0 to 1.2	1.25 to 1.55
	3.2±0.2	1.6±0.15	2.1 to 2.5	1.1 to 1.3	1.4 to 1.9
31 (1206)	3.2±0.2	1.6±0.2	2.1 to 2.5	1.1 to 1.3	1.6 to 2.0
	3.2±0.3	1.6±0.3			
	3.2±0.3	1.6±0.3			
32 (1210)	3.2±0.3	2.5±0.2	2.1 to 2.5	1.1 to 1.3	1.9 to 2.8

* Recommended land dimensions may differ depending on dimensional tolerance.

Design of printed circuit and Soldering

The recommended fillet height shall be 1/2 of the thickness of capacitors or 0.5mm. When mounting two or more capacitors in the common land, it is necessary to separate the land with the solder resist strike so that it may become the exclusive land of each capacitor.

Ideal Solder Height

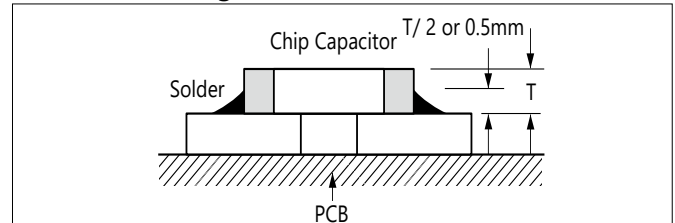

Item	Prohibited	Recommended example : Separation by solder resist
Multiple parts mount		
Mount with leaded parts		
Wire soldering after mounting		
Side by side layout		

Surface Mounting Information

Actual Mounting

- 1) If the position of the vacuum nozzle is too low, a large force may be applied to the chip capacitor during mounting, resulting in cracking.
- 2) During mounting, set the nozzle pressure to a static load of 1 to 3 N.
- 3) To minimize the shock of the vacuum nozzle, provide a support pin on the back of the PCB to minimize PCB flexure.
- 4) Bottom position of pick up nozzle should be adjusted to the top surface of a substrate which camber is corrected.

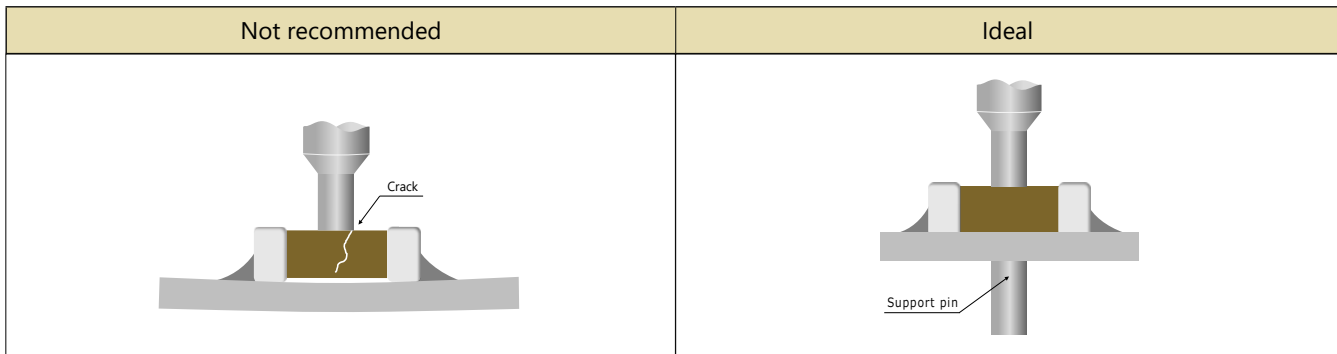

Mounting Design

The chip could crack if the PCB warps during processing after the chip has been soldered.

Recommended chip position on PCB to minimize stress from PCB warpage

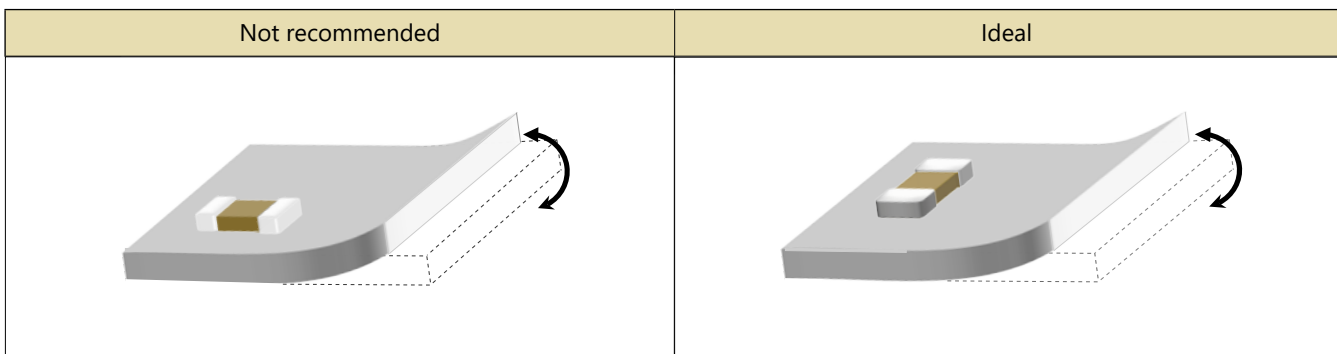

Soldering Method

- 1) Ceramic is easily damaged by rapid heating or cooling. If some heat shock is unavoidable, preheat enough to limit the temperature difference (Delta T) to within 150 degree Celsius.
- 2) The product size 1.6×0.8mm to 3.2×1.6mm can be used in reflow and wave soldering, and the product size of bigger than 3.2×1.6mm, or smaller than 1.6×0.8mm can be used in reflow.
Circuit shortage and smoking can be created by using capacitors which are used neglecting the above caution.
- 3) Please see our recommended soldering conditions.
- 4) In case of using Sn-Zn Solder, please contact us in advance.
- 5) The following condition is recommended for spot heater application.

· Recommended spot heater condition

Item	Condition
Distance	5mm min.
Angle	45°
Projection Temp.	400°C max.
Flow rate	Set at the minimum
Nozzle diameter	2φ to 4φ (Single hole type)
Application time	10 sec. max. (1206 and smaller) 30 sec. max. (1210 and larger)

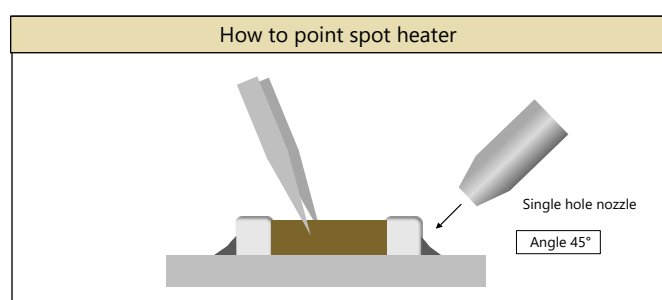

Surface Mounting Information

Recommended Temperature Profile (Sn-3Ag-0.5Cu)

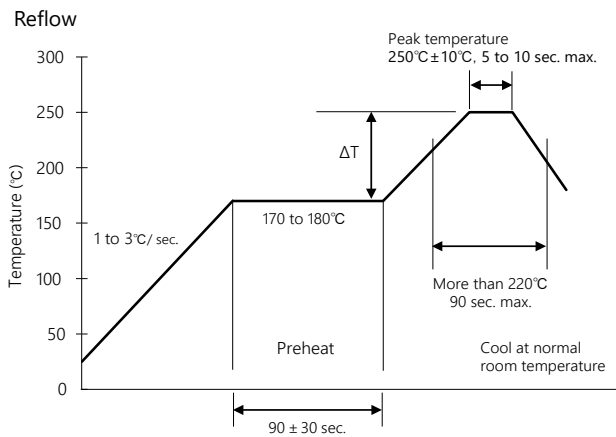

- ① Minimize soldering time.
- ② Ensure that allowable temperature difference does not exceed 150°C.
- ③ Ensure that allowable temperature difference does not exceed 130°C for 3.2×2.5mm size or larger.
- ④ MLCC can withstand the above reflow conditions up to 3 times.
- ⑤ N₂ atmosphere is recommended for reflow of products of 0.4mm×0.2mm size or smaller.

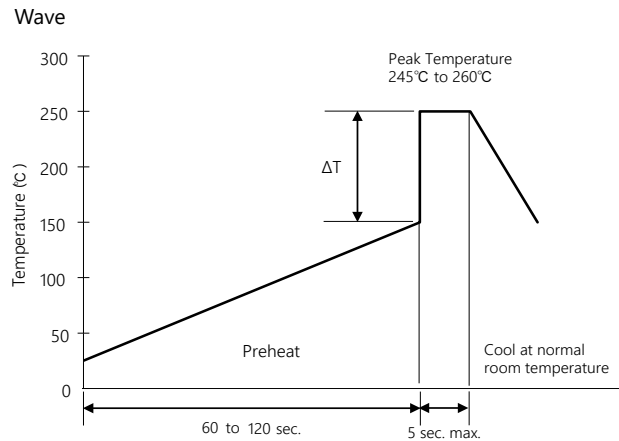

- ① Ensure that the chip capacitor is preheated adequately.
- ② Ensure that the temperature difference (ΔT) does not exceed 150°C.
- ③ Cool naturally after soldering.
- ④ Wave soldering is not applicable for chips with size of 3.2×2.5mm or larger of 1.0×0.5 mm or smaller and capacitor arrays.

Resin Mold

- 1) If a large amount of resin is used for molding the chip, cracks may occur due to contraction stress during curing. To avoid such cracks, use a low shrinkage resin.
- 2) The insulation resistance of the chip will degrade due to moisture absorption. Use a low moisture absorption resin.
- 3) Check carefully that the resin does not generate a decomposition gas or reaction gas during the curing process or during normal storage. Such gases may crack the chip capacitor or damage the device itself.

Precautions

Circuit Design

1. Once application and assembly environments have been checked, the capacitor may be used in conformance with the rating and performance which are provided in both the catalog and the specifications. Use exceeding that which is specified may result in inferior performance or cause a short, open, smoking, or flaming to occur, etc.
2. Please consult the manufacturer in advance when the capacitor is used in devices such as: devices which deal with human life, i.e. medical devices; devices which are highly public orientated; and devices which demand a high standard of liability.
Accident or malfunction of devices such as medical devices, space equipment and devices having to do with atomic power could generate grave consequence with respect to human lives or, possibly, a portion of the public. Capacitors used in these devices may require high reliability design different from that of general purpose capacitors.
3. Please use the capacitors in conformance with the operating temperature provided in both the catalog and the specifications.
Be especially cautious not to exceed the maximum temperature. In the situation the maximum temperature set forth in both the catalog and specifications is exceeded, the capacitor's insulation resistance may deteriorate, power may suddenly surge and short-circuit may occur.
The capacitor has a loss, and may self-heat due to equivalent series resistance when alternating electric current is passed therethrough. As this effect becomes especially pronounced in high frequency circuits, please exercise caution.
When using the capacitor in a (self-heating) circuit, please make sure the surface of the capacitor remains under the maximum temperature for usage. Also, please make certain temperature rises remain below 20°C.
4. Please keep voltage under the rated voltage which is applied to the capacitor. Also, please make certain the peak voltage remains below the rated voltage when AC voltage is super-imposed to the DC voltage.
In the situation where AC or pulse voltage is employed, ensure average peak voltage does not exceed the rated voltage.
Exceeding the rated voltage provided in both catalog and specifications may lead to defective withstanding voltage or, in worst case situations, may cause the capacitor to smoke or flame.
5. When the capacitor is to be employed in a circuit in which there is continuous application of a high frequency voltage or a steep pulse voltage, even though it is within the rated voltage, please inquire to the manufacturer.
In the situation the capacitor is to be employed using a high frequency AC voltage or a extremely fast rising pulse voltage, even though it is within the rated voltage, it is possible capacitor reliability will deteriorate.
6. It is a common phenomenon of high-dielectric products to have a deteriorated amount of static electricity due to the application of DC voltage.
Due caution is necessary as the degree of deterioration varies depending on the quality of capacitor materials, capacity, as well as the load voltage at the time of operation.
7. Do not use the capacitor in an environment where it might easily exceed the respective provisions concerning shock and vibration specified in the catalog and specifications.
In addition, it is a common piezo phenomenon of high dielectric products to have some voltage due to vibration or to have noise due to voltage change. Please contact sales in such case.
8. If the electrostatic capacity value of the delivered capacitor is within the specified tolerance, please consider this when designing the respective product in order that the assembled product function appropriately.
9. Please contact us upon using conductive adhesives.

Storage

Please note the following regarding the storage of delivered products.

1. Set the storage temperature to + 5 to + 40 °C and humidity to 20 ~ 70% RH. Other meteorological conditions are in accordance with classification 1 K2 of JIS C 60721 -3 -1.
2. Store in a place where corrosive gas (H₂S, SO₂, NO₂, Cl₂, etc.) does not exist in the atmosphere. Also, avoid exposure to salty moisture. In either case, this may cause oxidation corrosion of the terminal electrode, reducing solderability.

If you store the above delivered products according to the conditions listed above, it will satisfy the solderability standard for 6 months from the shipping date.

Safety application guideline and detailed information of electrical properties are also provided in kyocera web site;

URL: <https://ele.kyocera.com/en/product/capacitor/>



Notes for Using the Catalog

1. Specifications described in this catalog are for references. Products specifications shall be based on written documents agreed by each party.
2. Contents in this catalog are subject to change without notice. It is recommended to confirm the latest information at the time of usage. Also, Kyocera Electronic Components Catalog is revised once a year. We may not be able to accept requests based on old catalogs.
3. Products in this catalog are intended to be used in general electronic equipment such as office equipment, audio and visual equipment, communication equipment, measurement instrument and home appliances. It is absolutely recommended to consult with our sales representatives in advance upon planning to use our products in applications which require extremely high quality and reliability such as aircraft and aerospace equipment, traffic systems, safety systems, power plant and medical equipment including life maintenance systems.
4. Even though we strive for improvements of quality and reliability of products, it is requested to design with enough safety margin in equipment or systems in order not to threaten human lives directly or damage human bodies or properties by an accidental result of products.
5. It is requested to design based on guaranteed specifications for such as maximum ratings, operating voltage and operating temperature. It is not the scope of our guarantee for unsatisfactory results due to misuse or inadequate usage of products in the catalog.
6. Operation summaries and circuit examples in this catalog are intended to explain typical operation and usage of the product. It is recommended to perform circuit and assembly design considering surrounding conditions upon using products in this catalog.
7. Technical information described in this catalog is meant to explain typical operations and applications of products, and it is not intended to guarantee or license intellectual properties or other industrial rights of the third party or Kyocera.
8. Trademarks, logos and brand names used in this catalog are owned by Kyocera or the corresponding third party.
9. Certain products in this catalog are subject to the Foreign Exchange and Foreign Trade Control Act of Japan, and require the license from Japanese Government upon exporting the restricted products and technical information under the law.
Besides, it is requested not to use products and technical information in the catalog for the development and/or manufacture of weapons of mass destruction or other conventional weapons, nor to provide them to any third party with the possibility of having such purposes.
10. It is prohibited to reprint and reproduce a part or whole of this catalog without permission.
11. Contents described herein are as of January 2024.

单击下面可查看定价，库存，交付和生命周期等信息

[>>Kyocera\(京瓷\)](#)