

## Features

- Ultra low leakage: nA level
- Operating voltage: 24V
- Low clamping voltage
- Complies with following standards:
  - IEC 61000-4-2 (ESD) immunity test
    - Air discharge:  $\pm 30\text{kV}$
    - Contact discharge:  $\pm 30\text{kV}$
  - IEC61000-4-4 (EFT) 40A (5/50ns)
  - IEC61000-4-5 (Lightning) 3A (8/20  $\mu\text{s}$ )
- RoHS Compliant
- AEC-Q101 qualified

## Applications

- all key interfaces in automotive
- CAN-FD
- LIN
- FlexRay
- MOST
- SENT

## Mechanical Characteristics

- Package: SOT-323
- Lead Finish: Lead Free
- UL Flammability Classification Rating 94V-0
- Quantity Per Reel:3000pcs
- Reel Size:7 inch

## Absolute Maximum Ratings (T<sub>amb</sub>=25°C unless otherwise specified)

Parameter	Symbol	Value	Unit
Peak Pulse Power (8/20 $\mu\text{s}$ )	P <sub>pp</sub>	200	W
ESD per IEC 61000-4-2 (Air)	V <sub>ESD</sub>	$\pm 30$	Kv
ESD per IEC 61000-4-2 (Contact)		$\pm 30$	
Operating Temperature Range	T <sub>J</sub>	-55 to +125	°C
Storage Temperature Range	T <sub>STJ</sub>	-55 to +150	°C

## Dimensions SOT-323

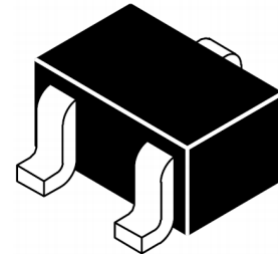

## Pin Configuration

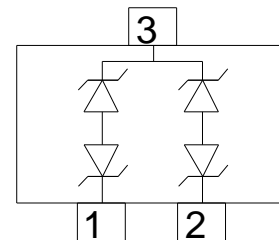

**Electrical Characteristics**( $T_A=25^{\circ}\text{C}$  unless otherwise specified)

Part Number	Device Marking	$V_{RWM}$ (V)	$V_{BR}$ (V)	$I_T$ (mA)	$V_C$ @1A	$V_C$		$I_R$ nA (Max)	C (Pf) (Typ.)
						(Max)	(@A)		
SMC24-323	C03	24	26.5	1	39	48	3	10	18

**Characteristic Curves**

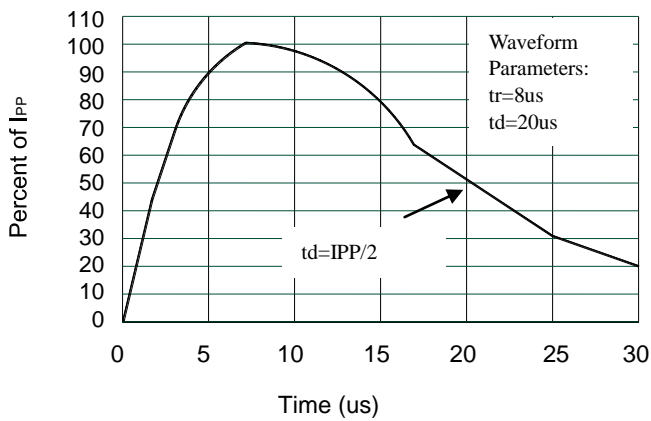

Pulse Waveform

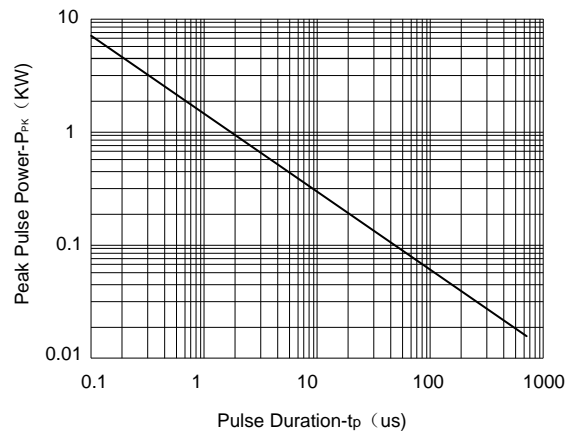

Non-Repetitive Peak Pulse Power vs. Pulse Time

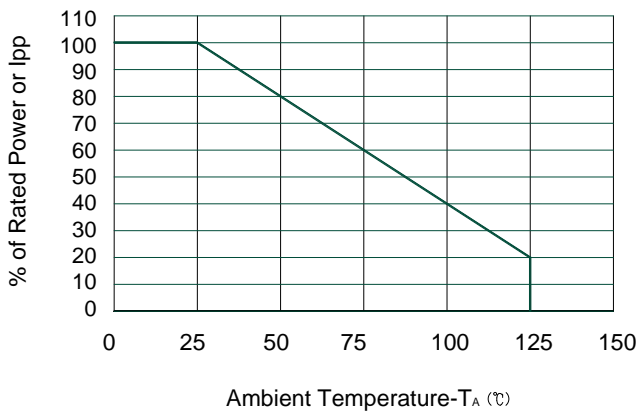

Power Derating Curve

## SOT-323 Package Outline & Dimensions

- Case: SOT323
- Case Material: Molded Plastic. UL Flammability

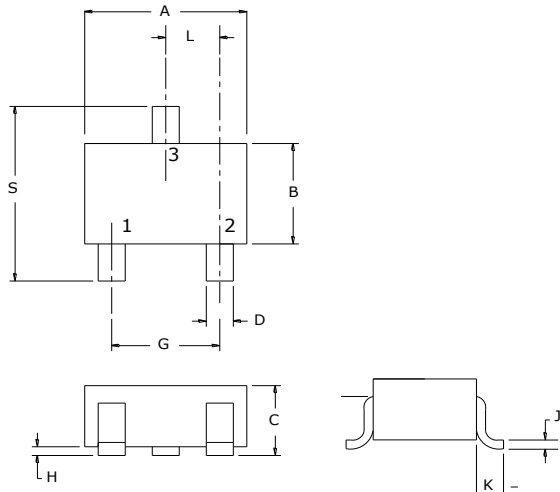

Dim	Millimeters	
	Min	Max
A	2.00	2.20
B	1.15	1.35
C	0.90	1.10
D	0.2	0.4
G	1.20	1.40
H	0.00	0.10
J	0.08	0.15
K	0.525REF	
L	0.650TYP	
S	2.15	2.45

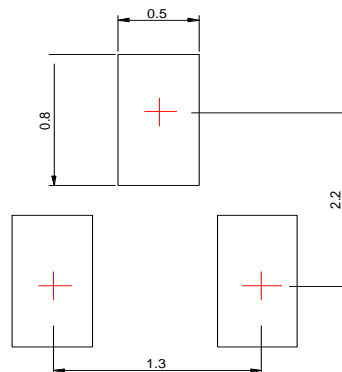

单击下面可查看定价，库存，交付和生命周期等信息

[>>Leiditech\(雷卯电子\)](#)