

Features

- Protects up to 5 lines
- Low leakage: nA level
- Low clamping voltage
- Excellent surge protection (100W at 8/20µs)
- Complies with following standards:
 - IEC 61000-4-2 (ESD) immunity test
 - Air discharge: ±30kV
 - Contact discharge: ±30kV
 - IEC61000-4-5 (Lightning) 8A (8/20µs)
- RoHS Compliant

Dimensions SOT-563

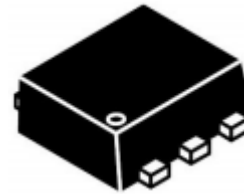

Applications

- Cellular Handsets & Accessories
- Personal Digital Assistants (PDAs)
- Notebooks & Handhelds
- Portable Instrumentation
- Digital Cameras
- MP3 Player

Pin Configuration

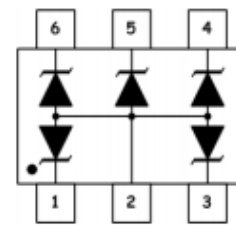

Mechanical Characteristics

- Package: SOT-563
- Lead Finish: Lead Free
- UL Flammability Classification Rating 94V-0
- Quantity Per Reel:4,000pcs
- Reel Size:7inch

Absolute Maximum Ratings (Tamb=25°C unless otherwise specified)

Parameter	Symbol	Value	Unit
Peak Pulse Power (8/20µs)	Ppp	100	W
ESD per IEC 61000-4-2 (Air)	V _{ESD}	±30	Kv
ESD per IEC 61000-4-2 (Contact)		±30	
Operating Temperature Range	T _J	-55 to +125	°C
Storage Temperature Range	T _{STJ}	-55 to +150	°C

Electrical Characteristics (TA=25°C unless otherwise specified)

Part Number	Device Marking	V _{RWM} (V)	V _{BR} (V)	I _T (mA)	V _C @1A	V _C		I _R μA (Max)	C (Pf) (Typ.)
						(Max)	(@A)		
SDA0505T6	U5S6	5	6	1	8	12	8	0.2	55

Typical Performance Characteristics ($T_A=25^\circ\text{C}$ unless otherwise Specified)

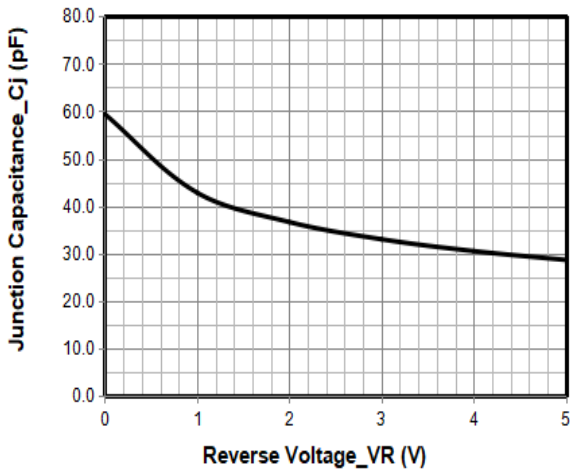

Junction Capacitance vs. Reverse Voltage

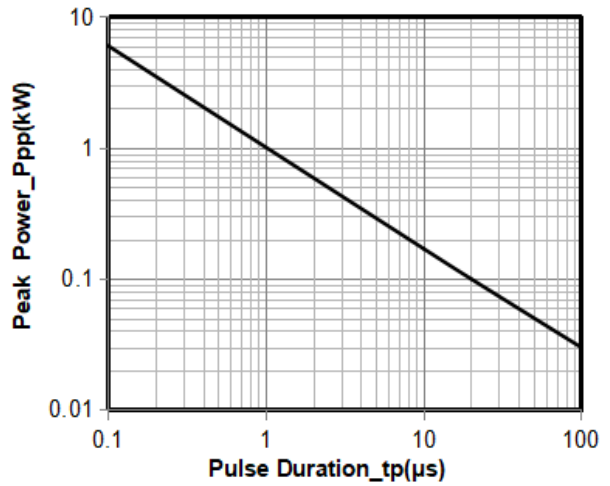

Peak Pulse Power vs. Pulse Time

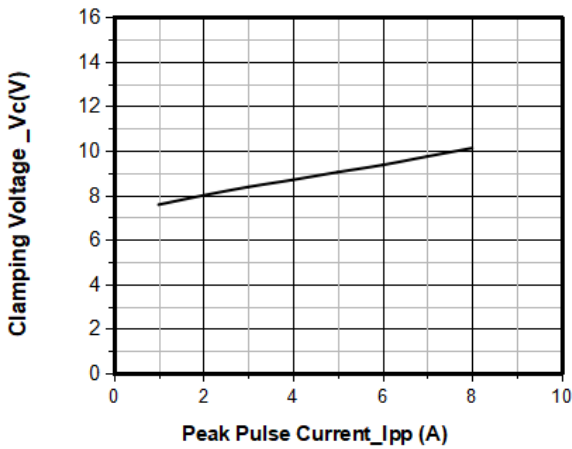

Clamping Voltage vs. Peak Pulse Current

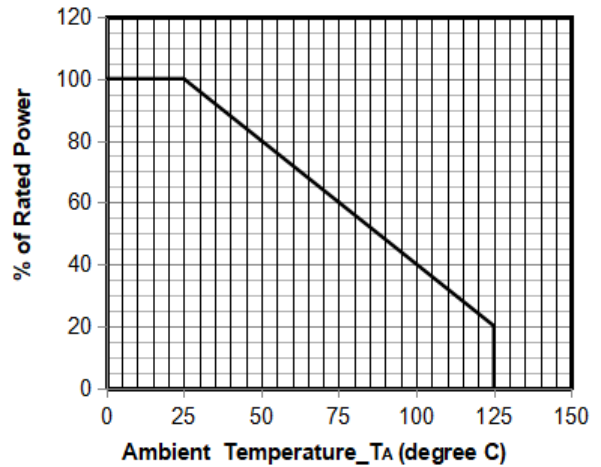

Power Derating Curve

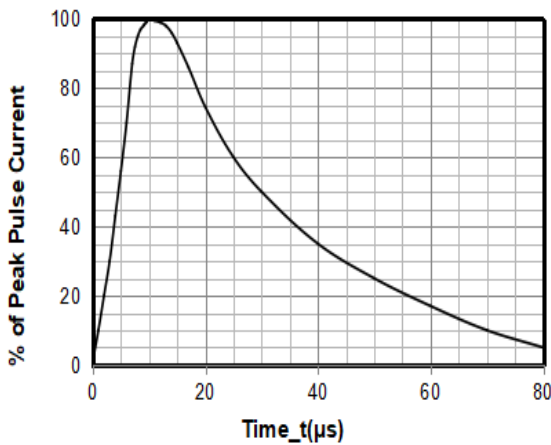

8 X 20 μs Pulse Waveform

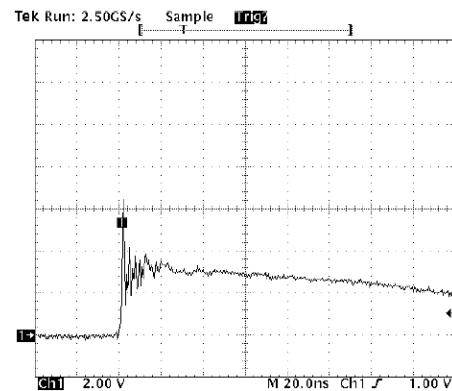

Note: Data is taken with a 10x attenuator

ESD Clamping Voltage

8 kV Contact per IEC61000-4-2

SOT-563 Package Outline Drawing

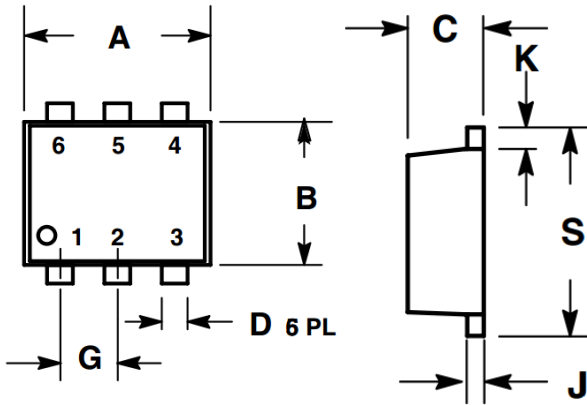

SYM	DIMENSIONS			
	MILLIMETERS		INCHES	
	MIN	MAX	MIN	MAX
A	1.50	1.70	0.059	0.067
B	1.10	1.30	0.043	0.051
C	0.50	0.60	0.020	0.024
D	0.17	0.27	0.007	0.011
G	0.50 BSC		0.020 BSC	
J	0.08	0.18	0.003	0.007
K	0.10	0.30	0.004	0.012
S	1.50	1.70	0.059	0.067

Suggested Land Pattern

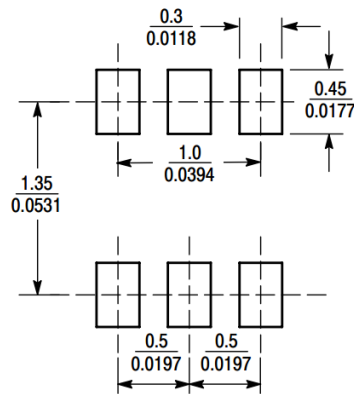

Unit: (mm)

单击下面可查看定价，库存，交付和生命周期等信息

[>>Leiditech\(雷卯电子\)](#)