

Ref: CKSR 25-NP/SP1, CKSR 50-NP/SP1

For the electronic measurement of current: DC, AC, pulsed..., with galvanic separation between the primary and the secondary circuit.

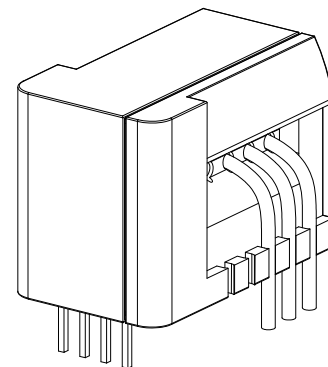

## Features

- Closed loop (compensated) multi-range current transducer
- Voltage output
- Single supply
- Compact design for PCB mounting.

## Special feature

- Dedicated 3 primary conductors configuration.

## Advantages

- Very low temperature coefficient of offset
- Very good  $dv/dt$  immunity
- Higher creepage distance/clearance
- Reduced height
- Reference pin with two modes: Ref IN and Ref OUT
- Extended measuring range for unipolar measurement.

## Applications

- AC variable speed and servo motor drives
- Static converters for DC motor drives
- Battery supplied applications
- Uninterruptible Power Supplies (UPS)
- Switched Mode Power Supplies (SMPS)
- Power supplies for welding applications
- Solar inverters.

## Standards

- EN 50178: 1997
- IEC 60950-1: 2006
- IEC 61010-1: 2010
- IEC 61326-1: 2012
- UL 508: 2010.

## Application Domain

- Industrial.

## Absolute maximum ratings

Parameter	Symbol	Unit	Value
Supply voltage	$U_C$	V	7
Primary conductor temperature	$T_B$	°C	110
Maximum primary current	$I_{P \max}$	A	$20 \times I_{PN}$
ESD rating, Human Body Model (HBM)	$U_{ESD}$	kV	4

Stresses above these ratings may cause permanent damage. Exposure to absolute maximum ratings for extended periods may degrade reliability.

## UL 508: Ratings and assumptions of certification

File # E189713 Volume: 2 Section: 1

### Standards

- CSA C22.2 NO. 14-10 INDUSTRIAL CONTROL EQUIPMENT - Edition 11 - Revision Date 2011/08/01
- UL 508 STANDARD FOR INDUSTRIAL CONTROL EQUIPMENT - Edition 17 - Revision Date 2010/04/15

### Ratings

Parameter	Symbol	Unit	Value
Primary involved potential		V AC/DC	1000
Max surrounding air temperature	$T_A$	°C	85
Primary current	$I_P$	A	According to series primary currents
Secondary supply voltage	$U_C$	V DC	7
Output voltage	$V_{out}$	V	0 to 5

### Conditions of acceptability

*When installed in the end-use equipment, consideration shall be given to the following:*

- 1 - These devices must be mounted in a suitable end-use enclosure.*
- 4 - CKSR series intended to be mounted on the printed circuit wiring board of the end-use equipment (with a minimum CTI of 100).*
- 5 - CKSR series shall be used in a pollution degree 2.*
- 8 - Low voltage circuits are intended to be powered by a circuit derived from an isolating source (such as transformer, optical isolator, limiting impedance or electro-mechanical relay) and having no direct connection back to the primary circuit (other than through the grounding means).*
- 11 - CKSR series: based on results of temperature tests, in the end-use application, a maximum of 100 °C cannot be exceeded at soldering joint between primary coil pin and soldering point (corrected to the appropriate evaluated max. surrounding air).*

### Marking

Only those products bearing the UL or UR Mark should be considered to be Listed or Recognized and covered under UL's Follow-Up Service. Always look for the Mark on the product.

**Insulation coordination**

Parameter	Symbol	Unit	Value	Comment
Rms voltage for AC insulation test, 50 Hz, 1 min	$U_d$	kV	4.3	
Impulse withstand voltage 1.2/50 $\mu$ s	$\hat{U}_w$	kV	8	
Partial discharge extinction rms voltage @ 10 pC	$U_e$	V	1000	
Clearance (pri. - sec.)	$d_{Cl}$	mm	8.2	Shortest internal distance through air (Note <sup>1)</sup> )
Creepage distance (pri. - sec.)	$d_{Cl}$	mm	8.2	Shortest internal path along device body (Note <sup>1)</sup> )
Clearance (pri. - sec.)	$d_{Cl}$	mm	12.3	Shortest external distance through air
Creepage distance (pri. - sec.)	$d_{Cl}$	mm	12.3	Shortest external path along device body
Case material	-	-	V0 according to UL 94	
Comparative tracking index	$CTI$		600	
Application example	-	-	1000 V CAT II PD2	Reinforced insulation, non uniform field according to IEC 61010-1
Application example	-	-	600 V CAT III PD2	Reinforced insulation, non uniform field according to EN 50178
Application example	-	-	1000 V CAT III PD2	Simple insulation, non uniform field according to EN 50178

Note: <sup>1)</sup> Inside device enclosure providing protection IP5x.

**Environmental and mechanical characteristics**

Parameter	Symbol	Unit	Min	Typ	Max	Comment
Ambient operating temperature	$T_A$	°C	-40		105	
Ambient storage temperature	$T_S$	°C	-55		105	
Mass	$m$	g		9		

**Electrical data CKSR 25-NP/SP1**

At  $T_A = 25\text{ °C}$ ,  $U_C = +5\text{ V}$ ,  $N_p = 1\text{ turn}$ ,  $R_L = 10\text{ k}\Omega$  internal reference unless otherwise noted (see Min, Max, typ. definition paragraph in page 9).

Parameter	Symbol	Unit	Min	Typ	Max	Comment
Primary nominal rms current	$I_{PN}$	A		25		Apply derating according to fig. 13
Primary current, measuring range	$I_{PM}$	A	-85		85	
Number of primary turns	$N_p$			1,2,3		
Supply voltage	$U_C$	V	4.75	5	5.25	
Current consumption	$I_C$	mA		$15 + \frac{I_P\text{ (mA)}}{N_s}$	$20 + \frac{I_P\text{ (mA)}}{N_s}$	$N_s = 1731\text{ turns}$
Reference voltage @ $I_p = 0\text{ A}$	$V_{ref}$	V	2.495	2.5	2.505	Internal reference
External reference voltage	$V_{ref}$	V	0		4	
Output voltage	$V_{out}$	V	0.375		4.625	
Output voltage @ $I_p = 0\text{ A}$	$V_{out}$	V		$V_{ref}$		
Electrical offset voltage	$V_{OE}$	mV	-1.35		1.35	100 % tested $V_{out} - V_{ref}$
Electrical offset current referred to primary	$I_{OE}$	mA	-54		54	100 % tested
Temperature coefficient of $V_{ref}$	$TCV_{ref}$	ppm/K		$\pm 5$	$\pm 50$	Internal reference
Temperature coefficient of $V_{out}$ @ $I_p = 0\text{ A}$	$TCV_{out}$	ppm/K		$\pm 1.4$	$\pm 4$	ppm/K of 2.5 V -40 °C ... 105 °C (at $\pm 6\text{ Sigma}$ )
Theoretical sensitivity	$G_{th}$	mV/A		25		$625\text{ mV}/I_{PN}$
Sensitivity error	$\epsilon_G$	%	-0.7		0.7	100 % tested
Temperature coefficient of G	$TCG$	ppm/K			$\pm 40$	-40 °C ... 105 °C
Linearity error	$\epsilon_L$	% of $I_{PN}$	-0.1		0.1	
Magnetic offset current ( $10 \times I_{PN}$ ) referred to primary	$I_{OM}$	A	-0.1		0.1	
Output rms current noise (spectral density) 100 Hz ... 100 kHz referred to primary	$I_{no}$	$\mu\text{A}/\text{Hz}^{1/2}$		20		$R_L = 1\text{ k}\Omega$
Peak-peak output ripple at oscillator frequency $f = 450\text{ kHz}$ (typ.)	-	mV		10	40	$R_L = 1\text{ k}\Omega$
Reaction time @ 10 % of $I_{PN}$	$t_{ra}$	$\mu\text{s}$			0.3	$R_L = 1\text{ k}\Omega$ , $di/dt = 68\text{ A}/\mu\text{s}$
Step response time to 90 % of $I_{PN}$	$t_r$	$\mu\text{s}$			0.3	$R_L = 1\text{ k}\Omega$ , $di/dt = 68\text{ A}/\mu\text{s}$
Frequency bandwidth ( $\pm 1\text{ dB}$ )	$BW$	kHz	200			$R_L = 1\text{ k}\Omega$
Frequency bandwidth ( $\pm 3\text{ dB}$ )	$BW$	kHz	300			$R_L = 1\text{ k}\Omega$
Overall accuracy	$X_G$	% of $I_{PN}$			1	
Overall accuracy @ $T_A = 85\text{ °C}$ (105 °C)	$X_G$	% of $I_{PN}$			1.35 (1.45)	
Accuracy	$X$	% of $I_{PN}$			0.8	
Accuracy @ $T_A = 85\text{ °C}$ (105 °C)	$X$	% of $I_{PN}$			1.15 (1.25)	

**Electrical data CKSR 50-NP/SP1**

At  $T_A = 25\text{ °C}$ ,  $U_C = +5\text{ V}$ ,  $N_P = 1$  turn,  $R_L = 10\text{ k}\Omega$  internal reference  $U_C$  unless otherwise noted (see Min, Max, typ. definition paragraph in page 9).

Parameter	Symbol	Unit	Min	Typ	Max	Comment
Primary nominal rms current	$I_{PN}$	A		50		Apply derating according to fig. 14
Primary current, measuring range	$I_{PM}$	A	-150		150	
Number of primary turns	$N_P$			1,2,3		
Supply voltage	$U_C$	V	4.75	5	5.25	
Current consumption	$I_C$	mA		$15 + \frac{I_P\text{ (mA)}}{N_S}$	$20 + \frac{I_P\text{ (mA)}}{N_S}$	$N_S = 966$ turns
Reference voltage @ $I_P = 0\text{ A}$	$V_{ref}$	V	2.495	2.5	2.505	Internal reference
External reference voltage	$V_{ref}$	V	0		4	
Output voltage	$V_{out}$	V	0.375		4.625	
Output voltage @ $I_P = 0\text{ A}$	$V_{out}$	V		$V_{ref}$		
Electrical offset voltage	$V_{OE}$	mV	-0.725		0.725	100 % tested $V_{out} - V_{ref}$
Electrical offset current referred to primary	$I_{OE}$	mA	-58		58	100 % tested
Temperature coefficient of $V_{ref}$	$TCV_{REF}$	ppm/K		$\pm 5$	$\pm 50$	Internal reference
Temperature coefficient of $V_{out}$ @ $I_P = 0\text{ A}$	$TCV_{out}$	ppm/K		$\pm 0.7$	$\pm 3$	ppm/K of 2.5 V -40 °C ... 105 °C (at $\pm 6$ Sigma)
Theoretical sensitivity	$G_{th}$	mV/A		12.5		$625\text{ mV}/I_{PN}$
Sensitivity error	$\epsilon_G$	%	-0.7		0.7	100 % tested
Temperature coefficient of $G$	$TCG$	ppm/K			$\pm 40$	-40 °C ... 105 °C
Linearity error	$\epsilon_L$	% of $I_{PN}$	-0.1		0.1	
Magnetic offset current ( $10 \times I_{PN}$ ) referred to primary	$I_{OM}$	A	-0.1		0.1	
Output rms current noise (spectral density) 100 Hz ... 100 kHz referred to primary	$I_{no}$	$\mu\text{A}/\text{Hz}^{1/2}$		20		$R_L = 1\text{ k}\Omega$
Peak-peak output ripple at oscillator frequency $f = 450\text{ kHz}$ (typ.)	-	mV		5	20	$R_L = 1\text{ k}\Omega$
Reaction time @ 10 % of $I_{PN}$	$t_{ra}$	$\mu\text{s}$			0.3	$R_L = 1\text{ k}\Omega$ , $di/dt = 100\text{ A}/\mu\text{s}$
Step response time to 90 % of $I_{PN}$	$t_r$	$\mu\text{s}$			0.3	$R_L = 1\text{ k}\Omega$ , $di/dt = 100\text{ A}/\mu\text{s}$
Frequency bandwidth ( $\pm 1\text{ dB}$ )	$BW$	kHz	200			$R_L = 1\text{ k}\Omega$
Frequency bandwidth ( $\pm 3\text{ dB}$ )	$BW$	kHz	300			$R_L = 1\text{ k}\Omega$
Overall accuracy	$X_G$	% of $I_{PN}$			0.9	
Overall accuracy @ $T_A = 85\text{ °C}$ (105 °C)	$X_G$	% of $I_{PN}$			1.2 (1.3)	
Accuracy	$X$	% of $I_{PN}$			0.8	
Accuracy @ $T_A = 85\text{ °C}$ (105 °C)	$X$	% of $I_{PN}$			1.1 (1.3)	

### Typical performance characteristics CKSR 25-NP/SP1

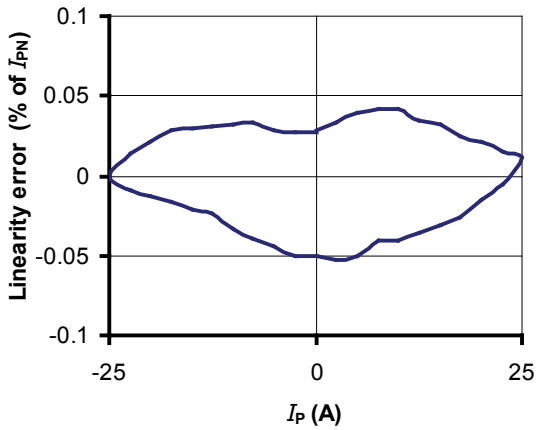

Figure 1: Linearity error

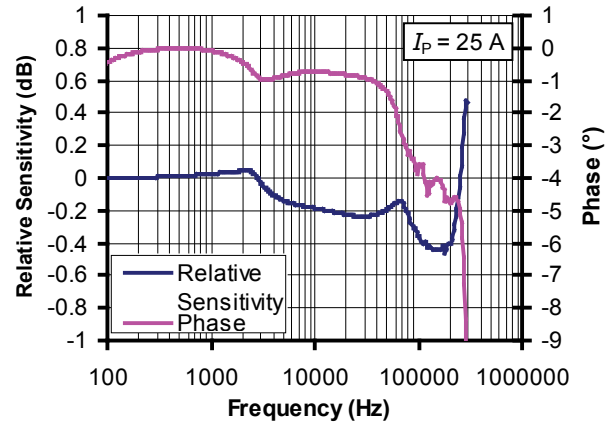

Figure 2: Frequency response

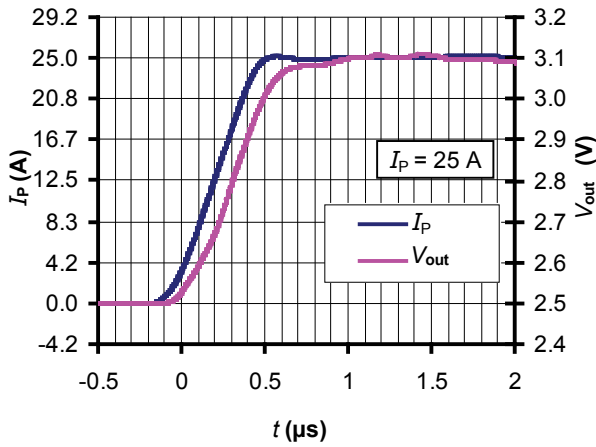

Figure 3: Step response

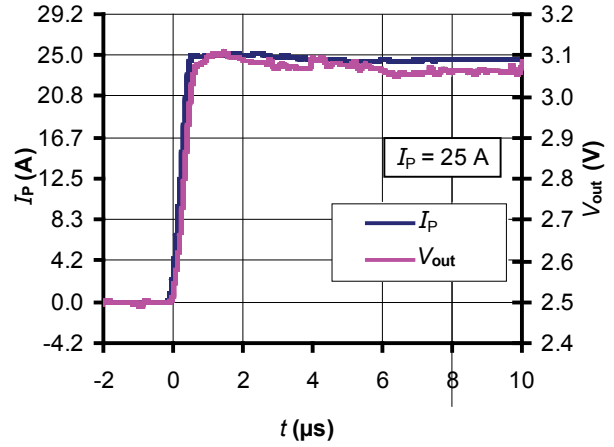

Figure 4: Step response

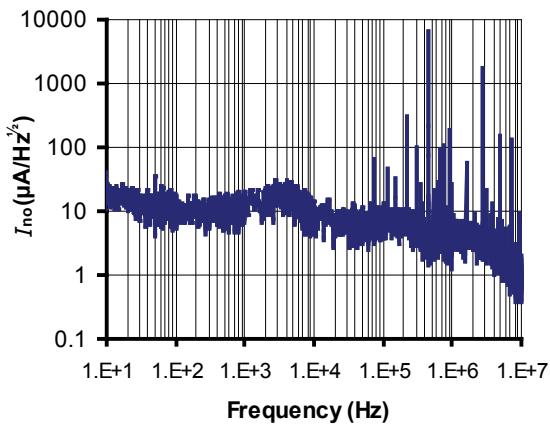

Figure 5: Input referred noise

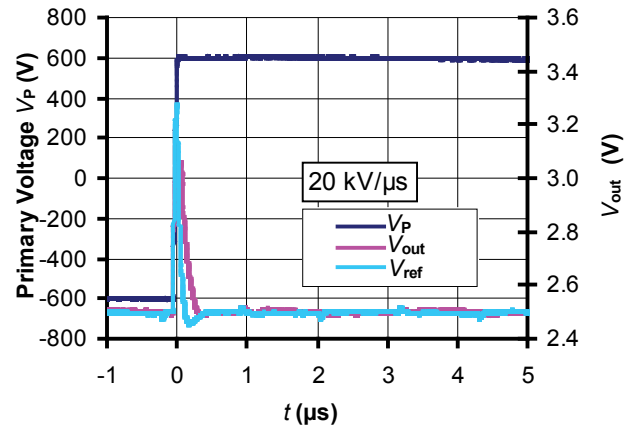

Figure 6: dv/dt

### Typical performance characteristics CKSR 50-NP/SP1

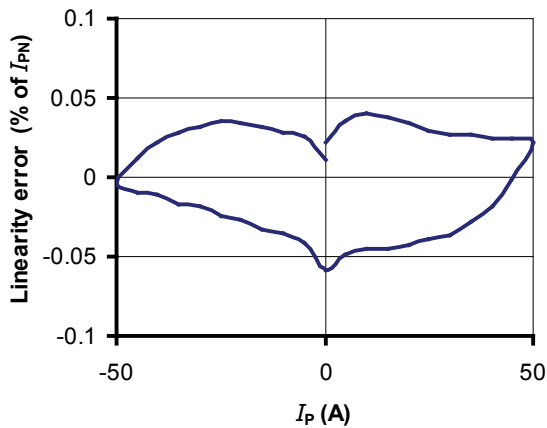

Figure 7: Linearity error

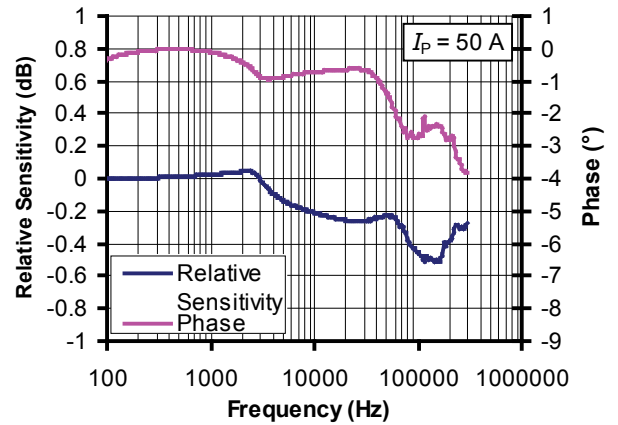

Figure 8: Frequency response

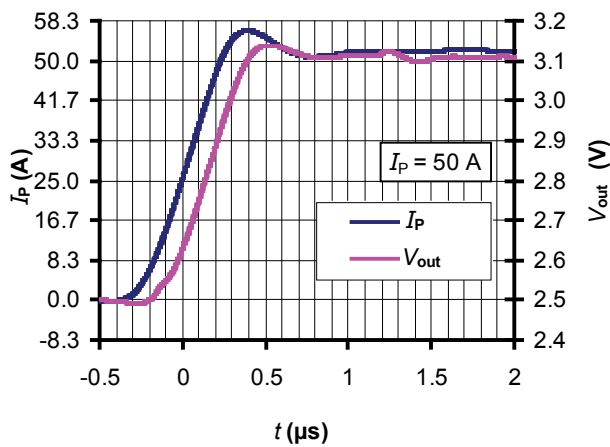

Figure 9: Step response

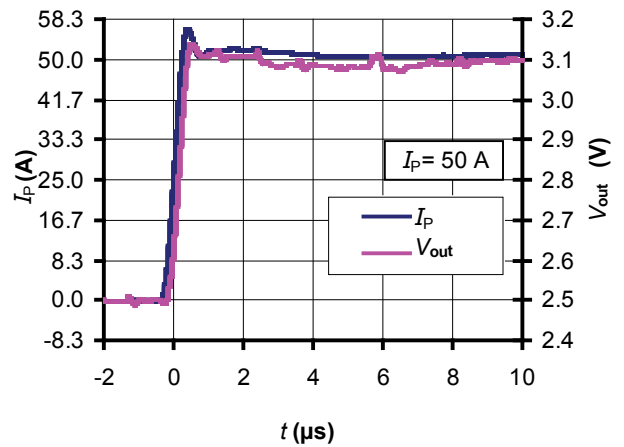

Figure 10: Step response

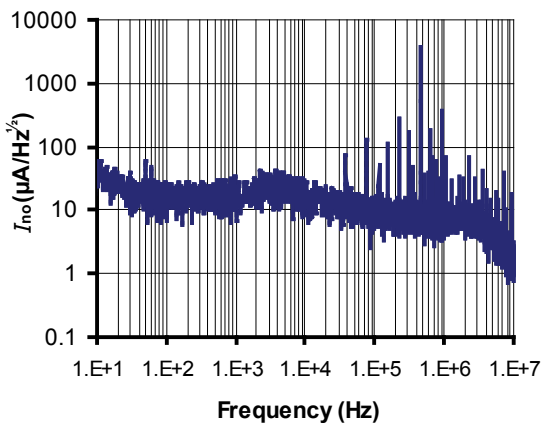

Figure 11: Input referred noise

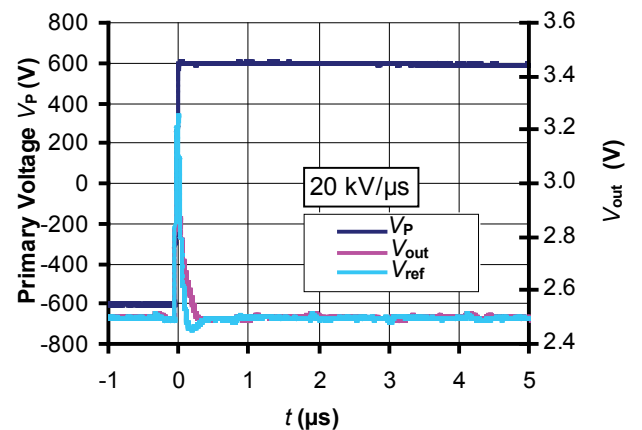
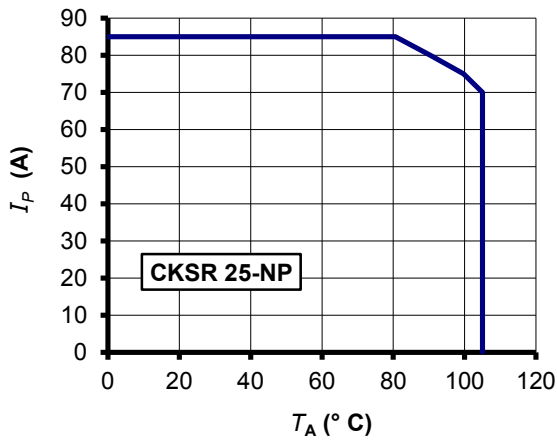
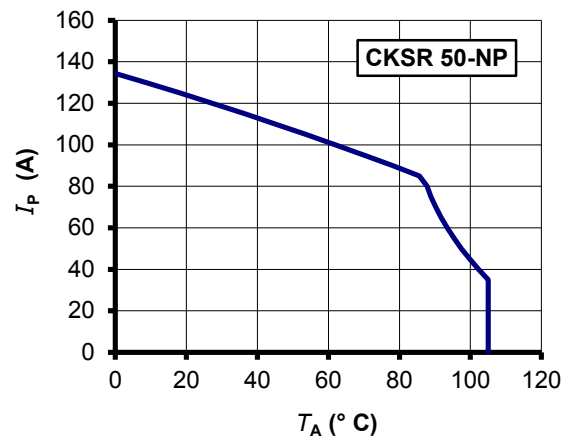

Figure 12: dv/dt

**Maximum continuous DC primary current**

 Figure 13:  $I_P$  vs  $T_A$  for CKSR 25-NP/SP1

 Figure 14:  $I_P$  vs  $T_A$  for CKSR 50-NP/SP1

The maximum continuous DC primary current plot shows the boundary of the area for which all the following conditions are true:

- $I_P < I_{PM}$
- Junction temperature  $T_J < 125$  °C
- Primary conductor temperature  $< 110$  °C
- Resistor power dissipation  $< 0.5 \times$  rated power

**Frequency derating**

Figure 15: Maximum rms AC primary current / maximum DC primary current vs frequency



## Performance parameters definition

### Ampere-turns and amperes

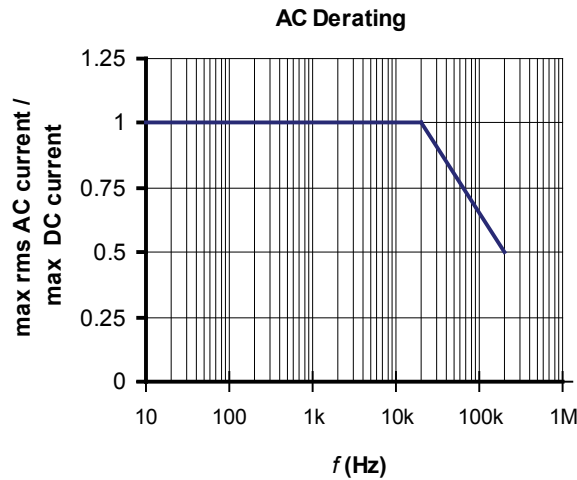
The transducer is sensitive to the primary current linkage  $\Theta_p$  (also called ampere-turns).

$$\Theta_p = N_p I_p (\text{At})$$

Where  $N_p$  the number of primary turn (depending on the connection of the primary jumpers)

Caution: As most applications will use the transducer with only one single primary turn ( $N_p = 1$ ), much of this datasheet is written in terms of primary current instead of current linkages. However, the ampere-turns (At) unit is used to emphasis that current linkages are intended and applicable.

### Transducer simplified model

The static model of the transducer at temperature  $T_A$  is:

$$V_{\text{out}} = G \Theta_p + \varepsilon$$

In which  $\varepsilon =$

$$V_{\text{OE}} + V_{\text{OT}}(T_A) + \varepsilon_G \cdot \Theta_p \cdot G + \varepsilon_L(\Theta_{P_{\text{max}}}) \cdot \Theta_{P_{\text{max}}} \cdot G + TCG \cdot (T_A - 25) \cdot \Theta_p \cdot G$$

- With:
- $\Theta_p = N_p I_p$  : primary current linkage (At)
  - $\Theta_{P_{\text{max}}}$  : max primary current linkage applied to the transducer
  - $V_{\text{out}}$  : output voltage (V)
  - $T_A$  : ambient operating temperature ( $^{\circ}\text{C}$ )
  - $V_{\text{OE}}$  : electrical offset voltage (V)
  - $V_{\text{OT}}(T_A)$  : temperature variation of  $V_{\text{O}}$  at temperature  $T_A$  ( $^{\circ}\text{C}$ )
  - $G$  : sensitivity of the transducer (V/At)
  - $TCG$  : temperature coefficient of  $G$
  - $\varepsilon_G$  : sensitivity error
  - $\varepsilon_L(\Theta_{P_{\text{max}}})$  : linearity error for  $\Theta_{P_{\text{max}}}$

This model is valid for primary ampere-turns  $\Theta_p$  between  $-\Theta_{P_{\text{max}}}$  and  $+\Theta_{P_{\text{max}}}$  only.

### Definition of typical, minimum and maximum values

Minimum and maximum values for specified limiting and safety conditions have to be understood as such as well as values shown in "typical" graphs. On the other hand, measured values are part of a statistical distribution that can be specified by an interval with upper and lower limits and a probability for measured values to lie within this interval.

Unless otherwise stated (e.g. "100 % tested"), the LEM definition for such intervals designated with "min" and "max" is that the probability for values of samples to lie in this interval is 99.73 %. For a normal (Gaussian) distribution, this corresponds to an interval between -3 sigma and +3 sigma. If "typical" values are not obviously mean or average values, those values are defined to delimit intervals with a probability of 68.27 %, corresponding to an interval between -sigma and +sigma for a normal distribution.

Typical, minimum and maximum values are determined during the initial characterization of a product.

### Sensitivity and linearity

To measure sensitivity and linearity, the primary current (DC) is cycled from 0 to  $I_{P1}$ , then to  $-I_{P1}$  and back to 0 (equally spaced  $I_{P1}/10$  steps). The sensitivity  $G$  is defined as the slope of the linear regression line for a cycle between  $\pm I_{P1}$ . The linearity error  $\varepsilon_L$  is the maximum positive or negative difference between the measured points and the linear regression line, expressed in % of  $I_{P1}$ .

### Magnetic offset

The magnetic offset current  $I_{\text{OM}}$  is the consequence of a current on the primary side ("memory effect" of the transducer's ferro-magnetic parts).

It is measured using the following primary current cycle.  $I_{\text{OM}}$  depends on the current value  $I_{P1}$  ( $I_{P1} > I_{PM}$ ).

$$I_{\text{OM}} = \frac{V_{\text{out}}(t_1) - V_{\text{out}}(t_2)}{2} \cdot \frac{1}{G_{\text{th}}}$$

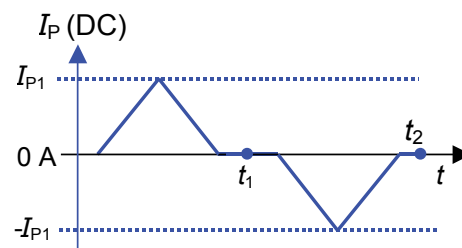

Figure 16: Current cycle used to measure magnetic and electrical offset (transducer supplied)

## Performance parameters definition (continued)

### Electrical offset

The electrical offset voltage  $V_{OE}$  can either be measured when the ferro-magnetic parts of the transducer are:

- completely demagnetized, which is difficult to realize,
- or in a known magnetization state, like in the current cycle shown in figure 16.

Using the current cycle shown in figure 16, the electrical offset is:

$$V_{OE} = \frac{V_{out}(t_1) + V_{out}(t_2)}{2}$$

The temperature variation  $V_{OT}$  of the electrical offset voltage  $V_{OE}$  is the variation of the electrical offset from 25 °C to the considered temperature:

Note: the transducer has to be demagnetized prior to the ap-

$$V_{OT}(T) = V_{OE}(T) - V_{OE}(25\text{ °C})$$

plication of the current cycle (for example with a demagnetization tunnel).

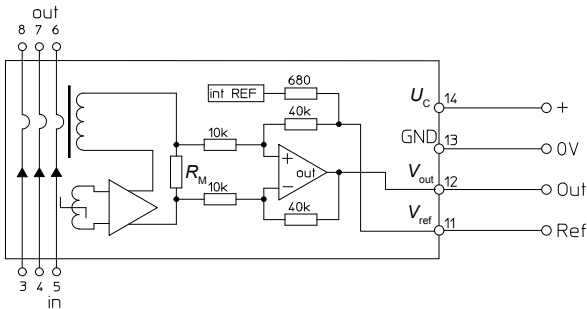

Figure 17: Test connection

### Overall accuracy

The overall accuracy at 25 °C  $X_G$  is the error in the  $-I_{PN} \dots +I_{PN}$  range, relative to the rated value  $I_{PN}$ .

It includes:

- the electrical offset  $V_{OE}$
- the sensitivity error  $\epsilon_G$
- the linearity error  $\epsilon_L$  (to  $I_{PN}$ )

The magnetic offset is part of the overall accuracy. It is taken into account in the linearity error figure provided the transducer has not been magnetized by a current higher than  $I_{PN}$ .

### Response and reaction times

The response time  $t_r$  and the reaction time  $t_{ra}$  are shown in figure 18.

Both depend on the primary current  $di/dt$ . They are measured at nominal ampere-turns.

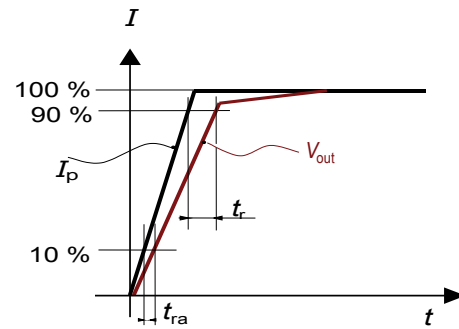

Figure 18: Response time  $t_r$  and reaction time  $t_{ra}$

## Application information

### Filtering and decoupling

#### Supply voltage $V_C$

The fluxgate oscillator draws current pulses of up to 30 mA at a rate of ca. 900 kHz. Significant 900 kHz voltage ripple on  $V_C$  can indicate a power supply with high impedance. At these frequencies the power supply rejection ratio is low, and the ripple may appear on the transducer output  $V_{out}$  and reference  $V_{ref}$ . The transducer has internal decoupling capacitors, but in the case of a power supply with high impedance, it is advised to provide local decoupling (100 nF or more, located close to the transducer).

#### Output $V_{out}$

The output  $V_{out}$  has a very low output impedance of typically 2 Ohms; it can drive 100 pF directly. Adding series  $R_f = 100$  Ohms allows much larger capacitive loads. Empirical evaluation may be necessary to obtain optimum results. The minimum load resistance on  $V_{out}$  is 1 kOhm.

#### Total Primary Resistance

The primary resistance is 0.72 mΩ per conductor.

In the following table, examples of primary resistance according to the number of primary turns.

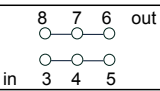
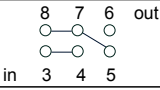
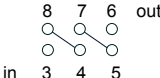
Number of primary turns	Primary resistance $R_p$ [mΩ]	Recommended connections
1	0.18	
2	1.08	
3	2.16	

#### Reference $V_{ref}$

Ripple present on the reference output can be filtered with a low value of capacitance because of the internal 680 Ohm series resistance. The maximum filter capacitance value is 1 μF.

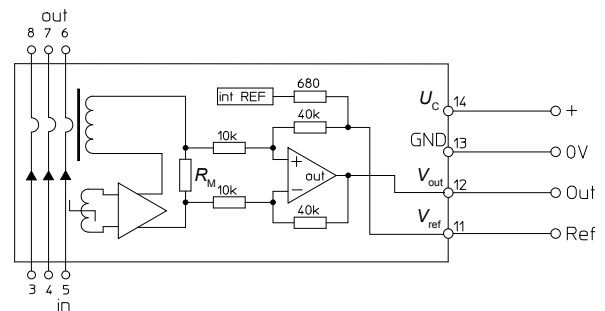

## External reference voltage

If the Ref pin of the transducer is not used it could be either left unconnected or filtered according to the previous paragraph "Reference  $V_{ref}$ ".

The Ref pin has two modes Ref IN and Ref OUT:

- In the Ref OUT mode the 2.5 V internal precision reference is used by the transducer as the reference point for bipolar measurements; this internal reference is connected to the Ref pin of the transducer through a 680 Ohms resistor. It tolerates sink or source currents up to  $\pm 5$  mA, but the 680 Ohms resistor prevents this current to exceed these limits.
- In the Ref IN mode, an external reference voltage is connected to the Ref pin; this voltage is specified in the range 0 to 4 V and is directly used by the transducer as the reference point for measurements. The external reference voltage  $V_{ref}$  must be able:

- either to source a typical current of  $\frac{V_{ref} - 2.5}{680}$ , the maximum value will be 2.2 mA typ. when  $V_{ref} = 4$  V.

- or to sink a typical current of  $\frac{2.5 - V_{ref}}{680}$ , the maximum value will be 3.68 mA typ. when  $V_{ref} = 0$  V.

The following graphs show how the measuring range of each transducer version depends on the external reference voltage value  $V_{ref}$ .

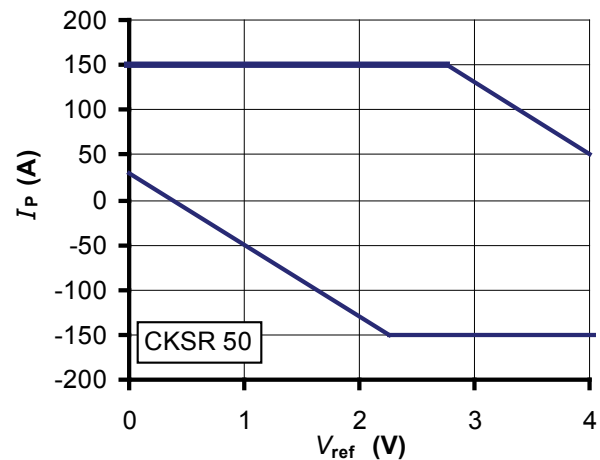
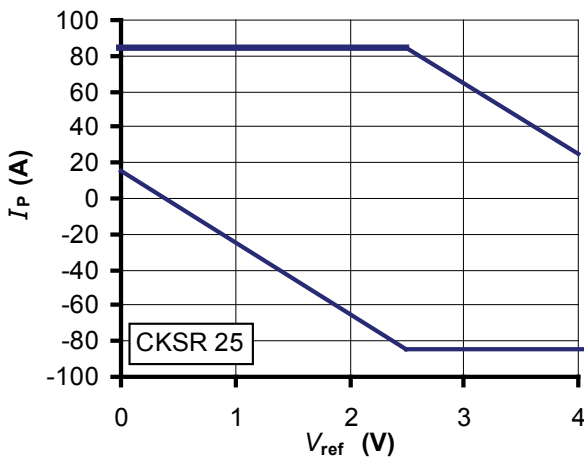

Upper limit:  $I_p = -40 * V_{ref} + 185$  ( $V_{ref} = 2.5 \dots 4$  V)  
 Upper limit:  $I_p = 85$  ( $V_{ref} = 0 \dots 2.5$  V)  
 Lower limit:  $I_p = -40 * V_{ref} + 15$  ( $V_{ref} = 0 \dots 2.5$  V)  
 Lower limit:  $I_p = -85$  ( $V_{ref} = 2.5 \dots 4$  V)

Upper limit:  $I_p = -80 * V_{ref} + 370$  ( $V_{ref} = 2.75 \dots 4$  V)  
 Upper limit:  $I_p = 150$  ( $V_{ref} = 0 \dots 2.75$  V)  
 Lower limit:  $I_p = -80 * V_{ref} + 30$  ( $V_{ref} = 0 \dots 2.25$  V)  
 Lower limit:  $I_p = -150$  ( $V_{ref} = 2.25 \dots 4$  V)

*Example with  $V_{ref} = 1.65$  V:*

- The 25 A version has a measuring range from -51 A to +85 A
- The 50 A version has a measuring range from -102 A to +150 A

*Example with  $V_{ref} = 0$  V:*

- The 25 A version has a measuring range from +15 A to +85 A
- The 50 A version has a measuring range from +30 A to +150 A

## PCB footprint

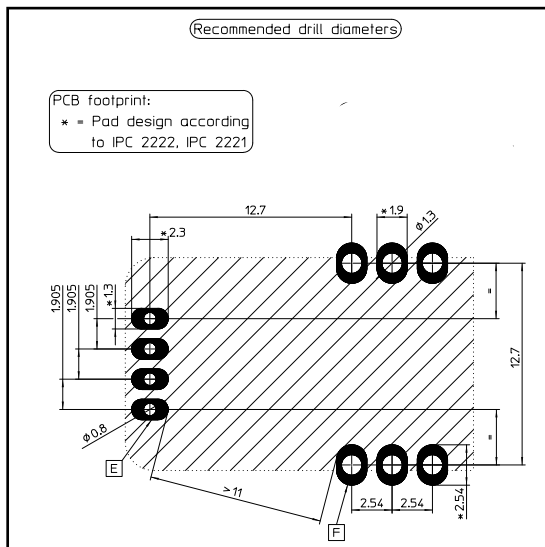

## Assembly on PCB

- Recommended PCB hole diameter      1.3 mm for primary pin  
0.8 mm for secondary pin
- Maximum PCB thickness                  2.4 mm
- Wave soldering profile                  maximum 260 °C for 10 s  
No clean process only

## Safety

This transducer must be used in limited-energy secondary circuits according to IEC 61010-1.



This transducer must be used in electric/electronic equipment with respect to applicable standards and safety requirements in accordance with the manufacturer's operating instructions.



Caution, risk of electrical shock

When operating the transducer, certain parts of the module can carry hazardous voltage (eg. primary busbar, power supply). Ignoring this warning can lead to injury and/or cause serious damage. This transducer is a build-in device, whose conducting parts must be inaccessible after installation. A protective housing or additional shield could be used. Main supply must be able to be disconnected.

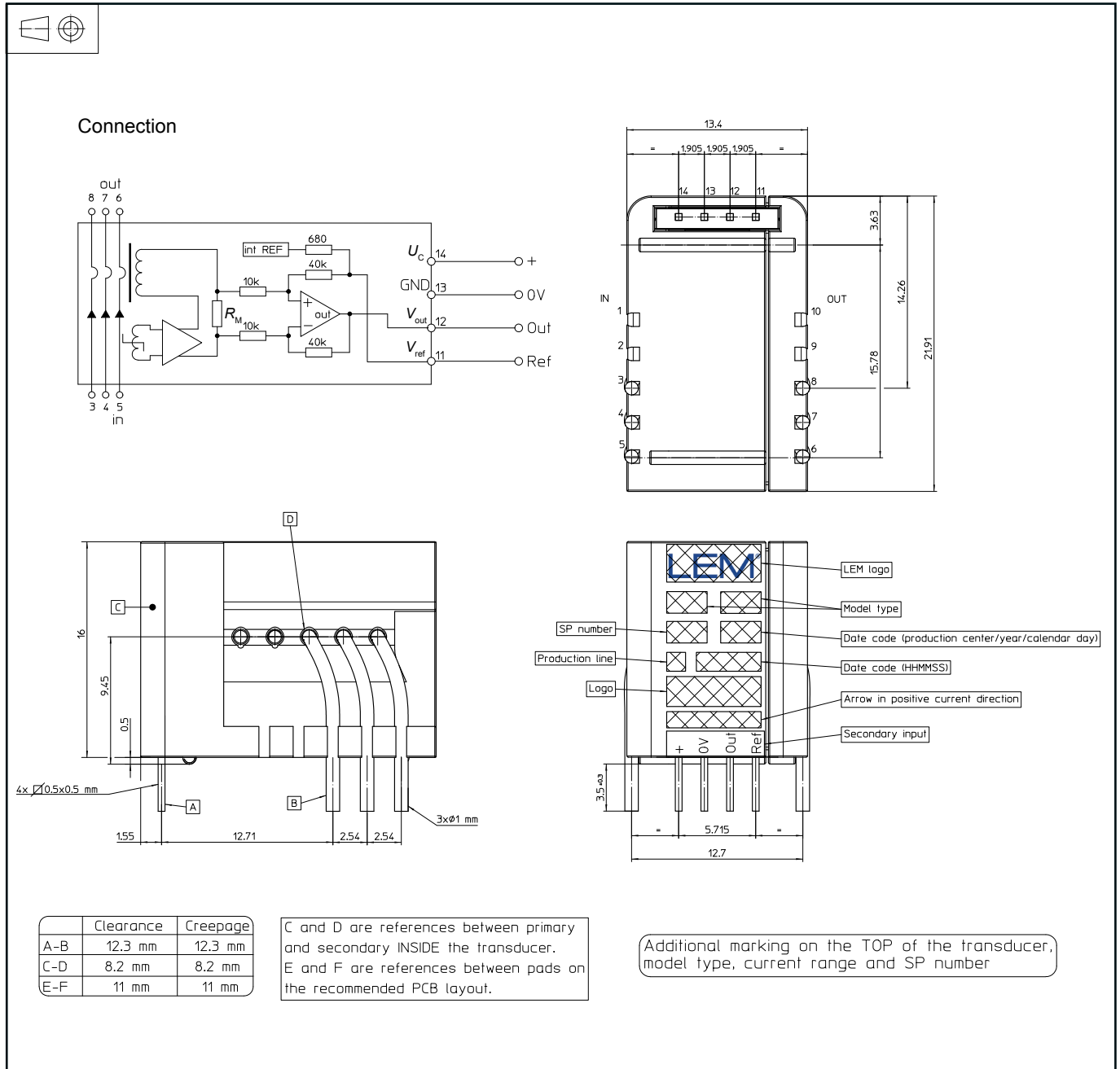
**Dimensions** (in mm, general linear tolerance  $\pm 0.25$  mm)

单击下面可查看定价，库存，交付和生命周期等信息

[>>LEM\(莱姆\)](#)