

AI-P1A

1 AMPERE OUTPUT ROGOWSKI COIL SIGNAL CONDITIONER



The Rogowski coil integrator AI-P1A complements LEM's flexible clip-around coil ART and ARU families to provide a 1 A output instantaneous signal to replace conventional current transformer with dynamic extended range. AI-P1A is DIN rail mounted.

Features

- Accuracy Class 0.5 (IEC 61869-2) ⁽¹⁾
- Linearity error $\leq 0.10\%$
- Protection degree IP2X
- 35 mm DIN rail mounted
- Push-in terminals
- 1 A instantaneous output signals
- 6 selectable sensitivities depending on Rogowski coil: 22.5, 70, 80, 85, 100, 120 mV/kA at 50 Hz
- 12 selectable ranges: 100, 200, 300, 400, 500, 600, 800, 1000, 1500, 2000, 4000, 5000 A
- Ambient operating temperature $-25 \dots +70\text{ }^{\circ}\text{C}$.

Advantages

- Compact design for DIN rail assembly
- High accuracy Class 0.5 (IEC 61869-2)
- Setup by user via Select / Edit buttons
- Clear status indication via bi-color led
- Over-temperature protection function.

Applications

- MV/LV substations: transformer condition monitoring
- Power measurement: current measurement for active power calculation
- Building sub-metering: energy efficiency monitoring, consumption analysis and cost allocation
- Power quality monitoring: electrical loads and distribution system equipment
- Fault Detection, Isolation and Repair (FDIR)
- Remote Terminal Units (RTU).

Standards

- Safety: IEC 61010-1: 2017
- EMC: IEC 61326-1: 2012
- UL 61010-1: Rev. 2016
- CAN/CSA C22.2 61010-1-12: Rev. 2016.

Options

- Cross Power Plug-in: side contacts to stack up to 3 Integrator modules and use only one power supply

Application Domains

- Industrial
- Smart grid.

Note: ¹⁾ AI-P1A integrators fulfill accuracy class limits defined by IEC 61869-2 even if this standard does not apply to Rogowski integrators. See detailed curve of accuracy given in this document.

Material and Insulation coordination

Parameter	Symbol	Unit	Value	Comment
RMS voltage for AC insulation test, 50 Hz, 5 seconds	U_d	kV	1.5	Between power supply 24 V and Rogowski connection + output
Flammability according to UL94	-	-	V0	-
Material	-	-	Polyamide	Halogen free

Environmental characteristics

Parameter	Symbol	Unit	Value	Comment
Ambient operating temperature ⁽¹⁾	T_A	°C	-25 ...+70	
Ambient storage temperature	T_{Ast}	°C	-40 ...+85	
Relative humidity (non-condensing)	RH	%	95	
Altitude above sea level	-	m	2000	
Mass	m	g	100	

Mechanical characteristics

Parameter	Symbol	Unit	Value	Comment
General dimensional tolerance	-	mm	±1	
Dimensions	-	mm ³	100 × 78 × 23.1	
Mounting on DIN rail (IEC 60715)	-	-	TH35-7.5 TH35-15	

Power Supply

Parameter	Symbol	Unit	Value	Comment
24 V DC Supply voltage	U_{CDC}	V	+16.8 ...+31.2	
Current consumption ⁽²⁾	I_C	mA	max. 350	@ 24 V with 1 A output
Auxiliary supply through micro-USB		V	5	For product configuration only

Notes: ¹⁾ The over-temperature protection may limit the output current in certain conditions of use. Please refer to the derating curve on page 5.

²⁾ Please refer to consumption curve on page 5.

Input Signal

Parameter	Symbol	Unit	Data	Comment
Rogowski coil sensitivity selection			With push buttons	See product configuration description
Selection indicator			bi-color LED	Green: Current range Red: Sensitivity & Output
Rogowski coil sensitivities		mV/kA	22.5, 70, 80, 85, 100, 120	At 50 Hz
Typical input impedance		kΩ	10	
Rated frequency	f_r	Hz	50 ... 60	Automatic recognition of grid frequency
Current measurement range selection			With push buttons	
Current measurement range		A	100, 200, 300, 400, 500, 600, 800, 1000, 1500, 2000, 4000, 5000	
Overcurrent measurement range		%	120	Overcurrent based on maximum value of the selected range
Short time withstand current on primary for 3 s ⁽¹⁾		kA	130	Worst case scenario with a Rogowski coil sensitivity of 120 mV/kA

Output Signal

Parameter	Symbol	Unit	Min	Typ	Max	Comment
0 ...1 A instantaneous current output mode	I_{out}	A	0	1	1.2	1 A @ 100% I range ⁽²⁾
Load resistance	R_L	Ω	0	-	1.5	
Temperature coefficient of s (all output mode)	TCS	ppm/K	-	-	150	From -25 °C ... +70 °C
Frequency bandwidth (@ -3 dB)	BW	Hz	9 1450	10 1500	11 1550	Low cut-off frequency High cut-off frequency
Phase displacement @ 50 Hz or 60 Hz	$\Delta\varphi$	°	-	-	0.2	
Accuracy class	-		-	0.5 ⁽³⁾	-	
Linearity error	ε_L	%			0.1	

Notes: 1) Maximum AI-P1A input voltage of 16 V for 3 s equivalent of measurement of short time current of 130 kA for 3 s with a Rogowski coil of 120 mV/kA sensitivity. For higher short time current rated network please consult our technical team.

2) Output signal is 1.2 A for 120% of I range, nevertheless the product is not intended to be used on continuous mode at this output level. Thermal protection may operate in case of thermal overload.

3) AI-P1A integrators fulfill accuracy class limits defined by IEC 61869-2 even if this standard does not apply to Rogowski integrators. See detailed curve of accuracy given in this document.

Definition of typical, minimum and maximum values

Minimum and maximum values for specified limiting and safety conditions have to be understood as such as well as values shown in “typical” graphs.

On the other hand, measured values are part of a statistical distribution that can be specified by an interval with upper and lower limits and a probability for measured values to lie within this interval.

Unless otherwise stated (e.g. “100 % tested”), the LEM definition for such intervals designated with “min” and “max” is that the probability for values of samples to lie in this interval is 99,73 %.

For a normal (Gaussian) distribution, this corresponds to an interval between -3 sigma and $+3$ sigma.

If “typical” values are not obviously mean or average values, those values are defined to delimit intervals with a probability of 68,27 %, corresponding to an interval between $-\sigma$ and $+\sigma$ for a normal distribution.

Typical, minimum and maximum values are determined during the initial characterization of the product.

Compatibility between current range selected and Coil sensibility selected

Current range and coil sensitivity should be chosen according to the table below.

		Coil sensibility selected					
		22.5	70	80	85	100	120
Current Range Selected	100	✓	✓	✓	✓	✓	✓
	200	✓	✓	✓	✓	✓	✓
	300	✓	✓	✓	✓	✓	✓
	400	✓	✓	✓	✓	✓	✓
	500	✓	✓	✓	✓	✓	✓
	600	✓	✓	✓	✓	✓	✓
	800	✓	✓	✓	✓	✓	✓
	1000	✓	✓	✓	✓	✓	✓
	1500	✓	✓	✓	✓	✓	✓
	2000	✓	✓	✓	✓	✓	✓
	4000	✓					
	5000	✓					

Front panel LED indicator

Green (x12)	Current range
Red (lower x6)	Input sensitivity
Range position blinking Red + Green	Input overload
Running light	Over temperature protection activated (output disabled)

AI-P1A output current vs load resistance

Ambient temperature 25 °C ... 70 °C ¹⁾

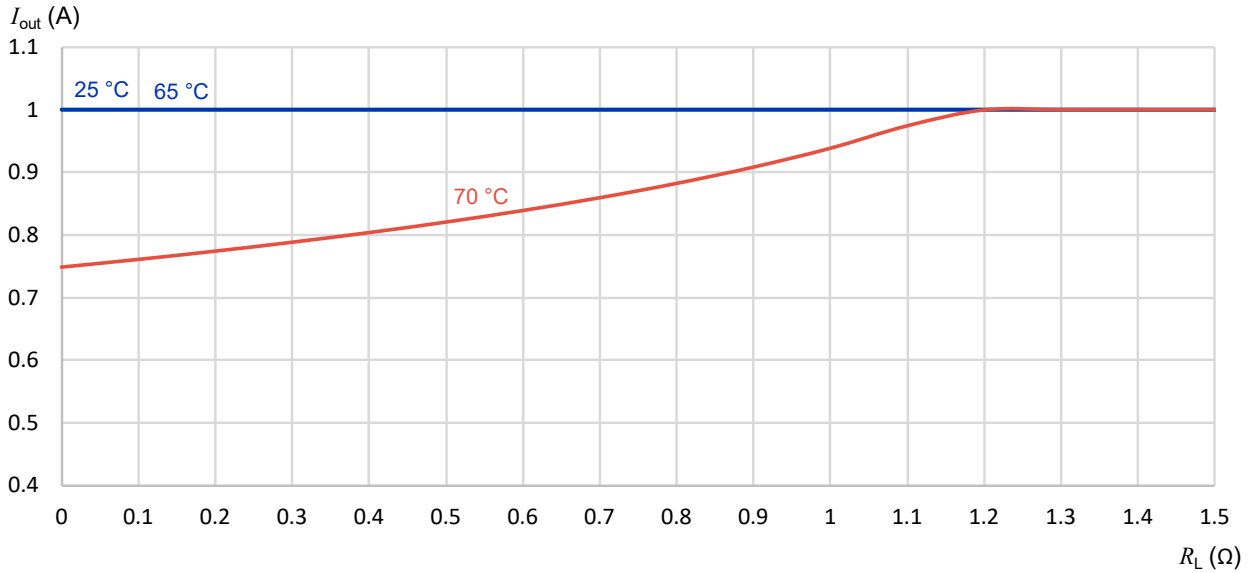

Note: ¹⁾ Typical values measured in laboratory conditions (climatic chamber, stirred air)

AI-P1A current consumption vs temperature

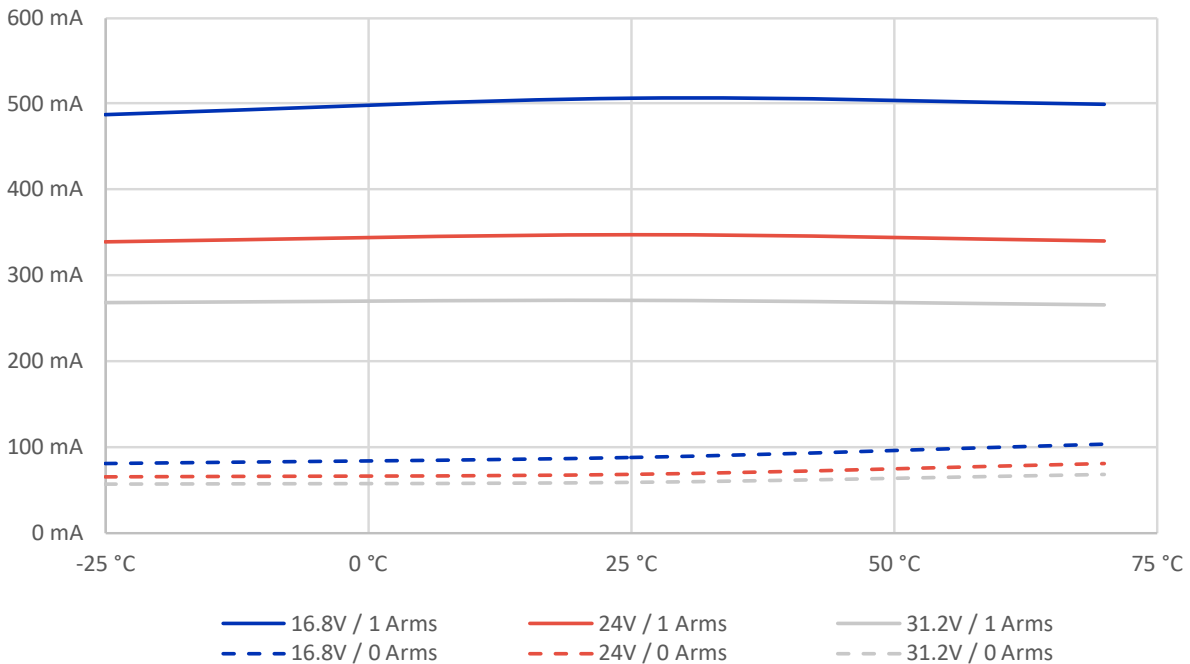

Supply voltage 16.8 V ... 31.2 V

Output current 0 ARMS and 1 ARMS

Typical performance characteristics, Range 100 A

Output 0 ... 1 A, Sensitivity 22.5 mV/kA

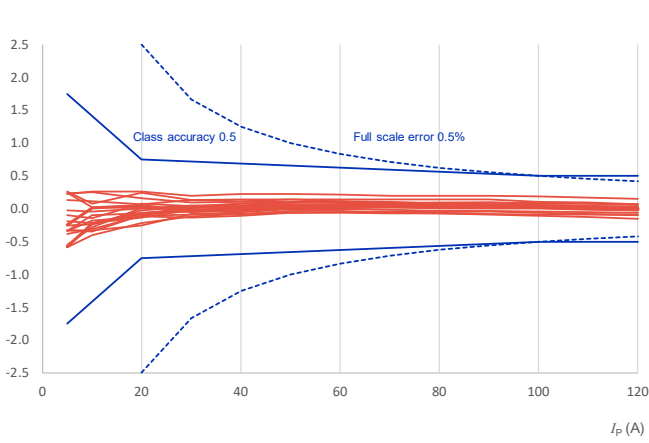

Measurement error (%) @ 25 °C

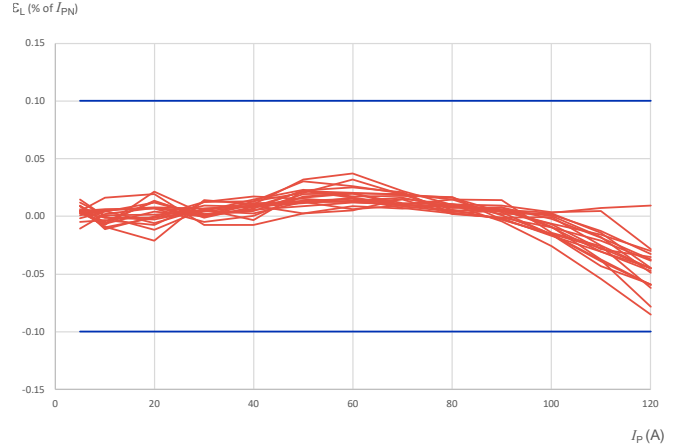

Linearity error (% of I_{PN}) @ 25 °C

Typical performance characteristics, Range 1000 A

Output 0 ... 1 A, Sensitivity 22.5 mV/kA

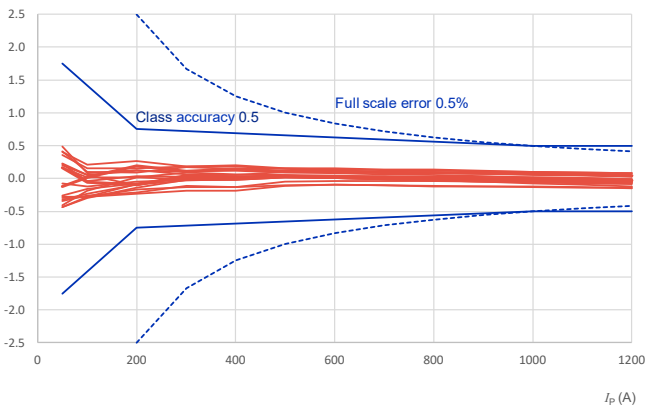

Measurement error (%) @ 25 °C

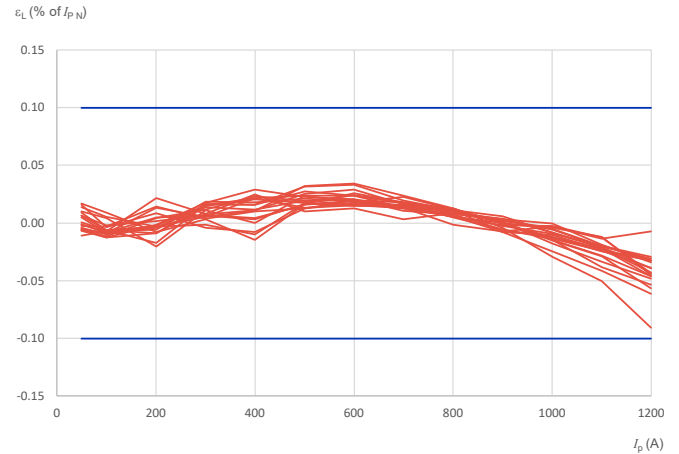

Linearity error (% of I_{PN}) @ 25 °C

Example of application

Product configuration:

- Range (green LED): 5000 A
- Output signal: 0 ... 1.2 A
- Sensitivity (red LED): 22.5 mV/kA

The graph hereafter gives conversion between the primary current, the voltage output of Rogowski coil and the output voltage of the AI-P1A.

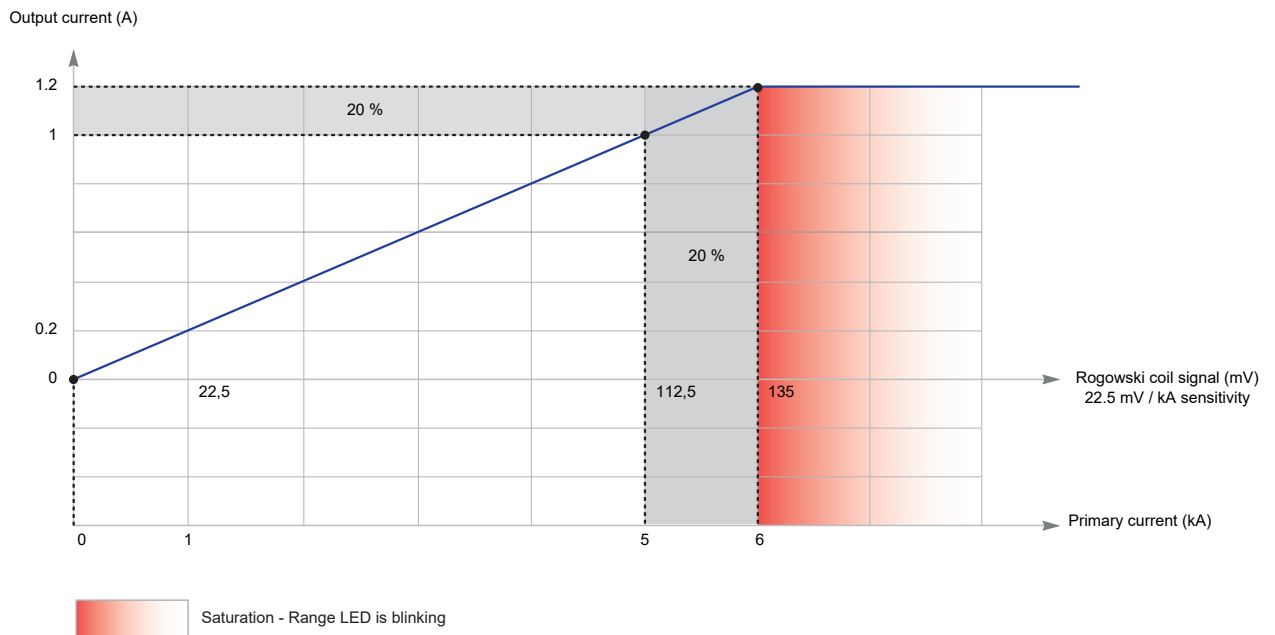

Example of typical transient response output 0 ... 1 A

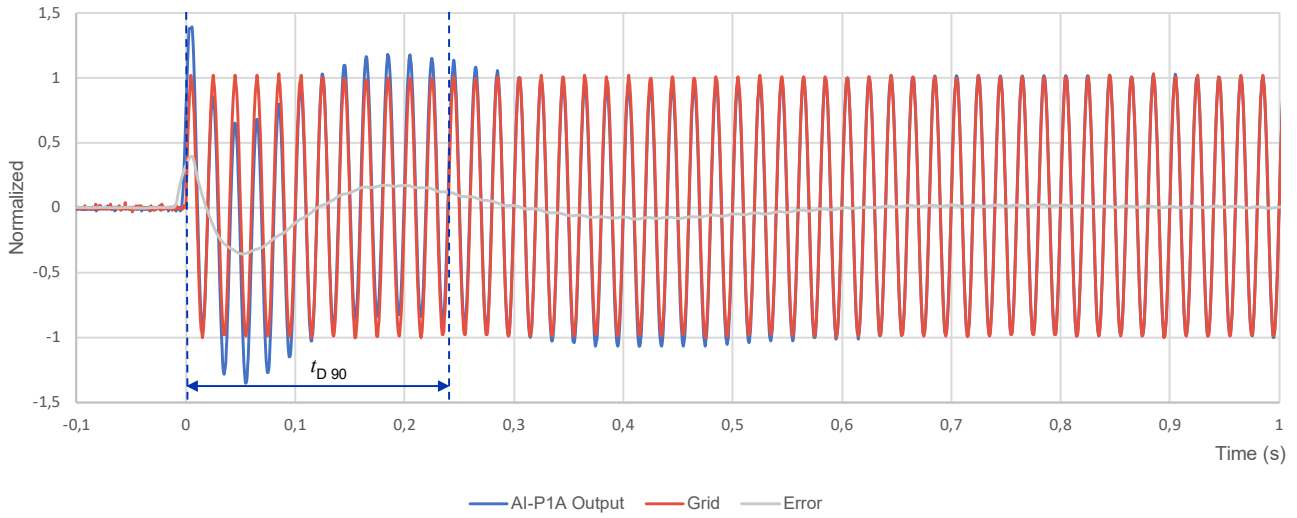

Current rise $t_{D\ 90} < 240\text{ ms}$

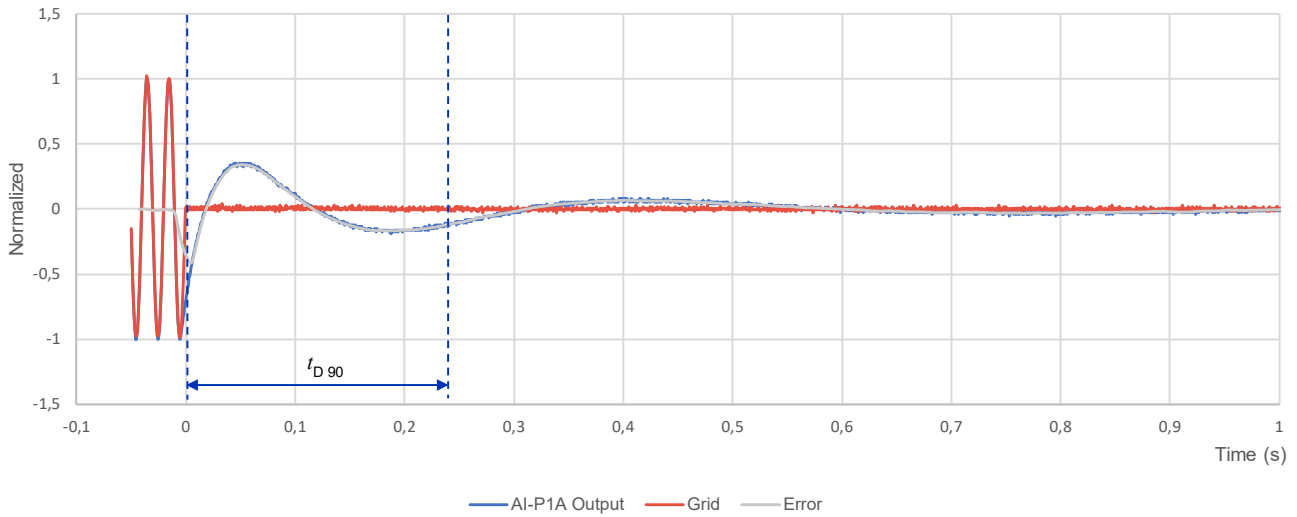

Current fall $t_{D\ 90} < 240\text{ ms}$

Connections and Interfaces

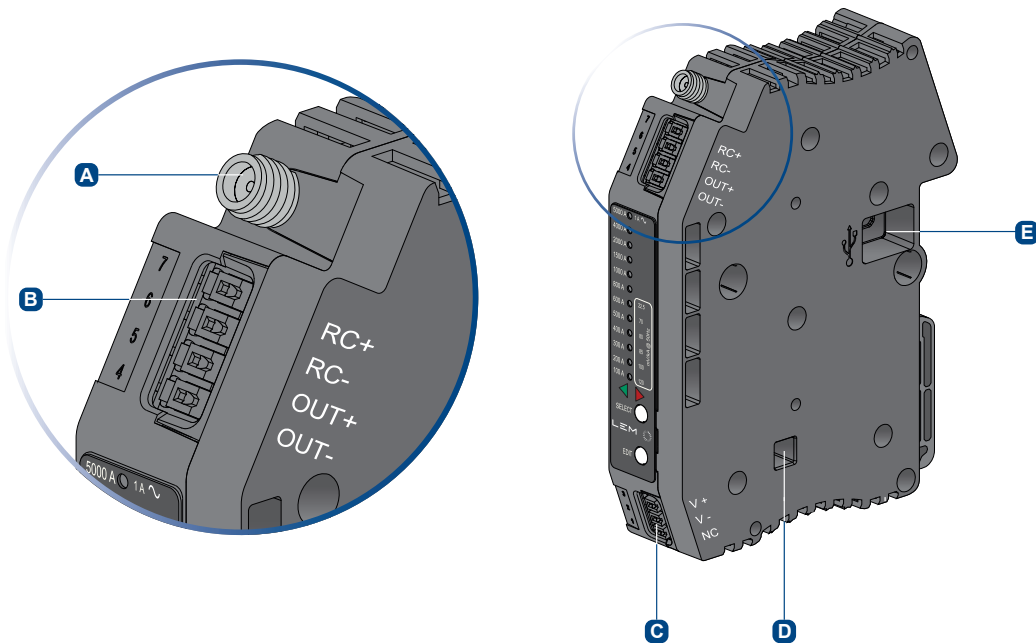

- A SMA Input for Rogowski coil (optional)**
Section: 0.13 ... 1.5 mm²
- B Terminal input coil and output signal**
Section: 0.13 ... 1.5 mm²
- C Power supply terminals (DC, 24 V)**
Section: 0.13 ... 1.5 mm² (24 ... 16 AWG)
Third pin not connected

- D Cross Power plug-in**
Side contacts to stack up to 3 Integrator modules and use only 1 power supply.
- E Micro USB**
Energise AI-1A for configuration without connecting 24 V DC supply.

Parameter	Unit	Min	Typ	Max	Comment
Type			Push-in		
Clamping range	mm ²	0.13	-	1.5	
Cross section	AWG	24	-	16	
Stripping length	mm	9.5	10	10.5	

AI-P1A series: name and codification

AI-P1A

Family:
AC Integrator

Case type / Output signal 1 A:
P: DIN RAIL mounting / 1 Ampere output

Description	Item Number	Comment
AI-P1A	90.T7.99.000.0	Integrator 1A standard for automation applications
AI ACCESSORY KIT M2 CROSS POWER PLUG-IN ⁽¹⁾	90.T8.98.001.0	Cross Power plug-in accessory: Kit to connect 2 integrators power supplies

Dimensions (in mm)

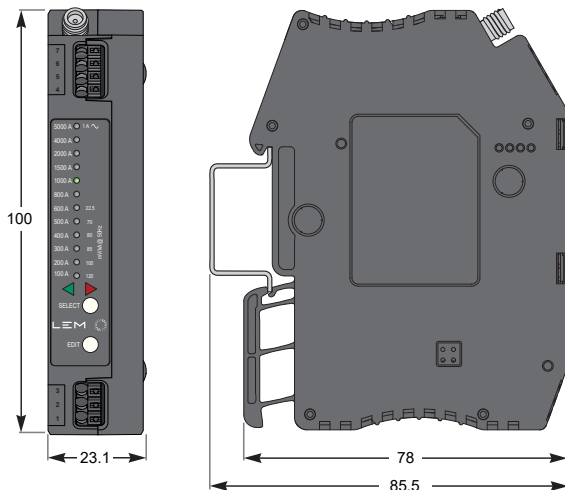

Installation, removal, wiring

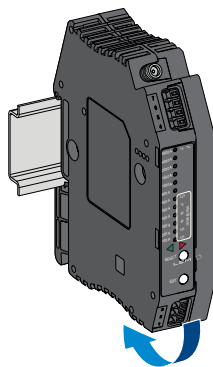

To install, rotate terminal to mount on the rail DIN

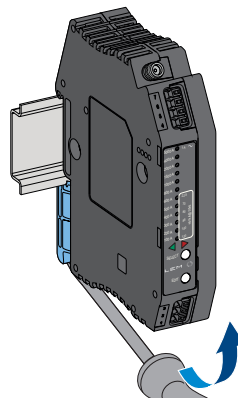

To remove the device, use a 4 mm flat screwdriver

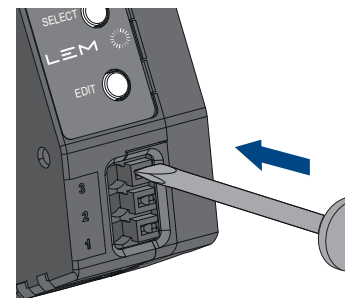

To remove wiring easily, use any tools or a 2.5 mm flat screwdriver

Note: ¹⁾ the stacking of 3 AI-P1A with this kit may reduce the maximum temperature before triggering the over-temperature protection. A special care must be taken in the installation and venting conditions

Safety and warning notes

In order to guarantee safe operation of the signal conditioner and to be able to make proper use of all features and functions, please read these instructions thoroughly!

Safe operation can only be guaranteed if the signal conditioner is used for the purpose it has been designed for and within the limits of the technical specifications.

Caution

Ignoring the warnings can lead to serious injury and/or cause damage! The electric measuring signal conditioner may only be installed and put into operation by qualified personnel that have received an appropriate training. The corresponding national regulations shall be observed during installation and operation of the signal conditioner and any electrical conductor. The signal conditioner shall be used in electric/electronic equipment with respect to applicable standards and safety requirements and in accordance with all the related systems and components manufacturers' operating instructions.

The product must be powered by a limited power source. The product shall be operated with Rogowski Coil compliant with IEC 61010-2-032. Consistency of measurements during maintenance operations shall be checked. Consistency of measurement during commissioning and maintenance shall be checked with suitable means (clamp-on ammeter). Product shall not saturate .

Caution, possibility of electric shock

When operating the signal conditioner, certain parts next to the signal conditioner may carry hazardous live voltage. The user shall ensure to take all measures necessary to be protected against electrical shock. Certain parts may contain conducting parts that shall not be accessible after installation. A protective enclosure or additional insulation barrier may be necessary. Installation and maintenance shall be done with the main power supply disconnected except if there are no hazardous live parts in or in close proximity to the system and if the applicable national regulations are fully observed.

Safe and trouble-free operation of this signal conditioner can only be guaranteed if transport, storage and installation are carried out correctly and operation and maintenance are carried out with care. The signal conditioner shall not be opened or modified. If not working, the signal conditioner shall be replaced by an equivalent device. To avoid electrical burn, electric shock or arc flash, do not install Rogowski coils on or remove them from hazardous live conductors. Any connection to the product shall fulfil the requirements for safety extra low voltage (SELV) circuits.

单击下面可查看定价，库存，交付和生命周期等信息

[>>LEM\(莱姆\)](#)