

# Voltage Transducer DVM-B series

$U_{PN} = 2000 \dots 4000 \text{ V}$

Ref: DVM 2000-B; DVM 4000-B

For the electronic measurement of voltage: DC, AC, pulsed..., with galvanic separation between the primary and the secondary circuit.



## Features

- Bipolar and insulated measurement of voltage
- Voltage output
- Input connections with M5 studs and output connections with M5 threaded inserts.

## Advantages

- Low consumption and low losses
- Compact design
- Very low sensitivity to common mode voltage variations
- Excellent accuracy (offset, sensitivity, linearity)
- Fast delay time
- Low temperature drift
- High immunity to external interferences.

## Applications

- Single or three phase inverters
- Propulsion and braking choppers
- Propulsion converters
- Auxiliary converters
- High power drives
- Substations.

## Standards

- EN 50155: 2017
- EN 50121-3-2: 2016
- EN 50124-1: 2017
- IEC 62497-1: 2010
- IEC 61010-1: 2010
- IEC 62477-1: 2012
- UL 347 <sup>1)</sup>: 2016.

## Application Domain

- Industrial
- Railway (fixed installations and onboard).

Note: When used with UL 347 Isolator N° 92.24.06.420.0.

## Safety



Caution

If the device is used in a way that is not specified by the manufacturer, the protection provided by the device may be compromised. Always inspect the electronics unit and connecting cable before using this product and do not use it if damaged. Mounting assembly shall guarantee the maximum primary conductor temperature, fulfill clearance and creepage distance, minimize electric and magnetic coupling, and unless otherwise specified can be mounted in any orientation.



Caution, risk of electrical shock

This transducer must be used in limited-energy secondary circuits SELV according to IEC 61010-1, in electric/electronic equipment with respect to applicable standards and safety requirements in accordance with the manufacturer's operating specifications.

Use caution during installation and use of this product; certain parts of the module can carry hazardous voltages and high currents (e.g. power supply, primary conductor).

Ignoring this warning can lead to injury and or/or cause serious damage.

De-energize all circuits and hazardous live parts before installing the product.

All installations, maintenance, servicing operations and use must be carried out by trained and qualified personnel practicing applicable safety precautions.

This transducer is a build-in device, whose hazardous live parts must be inaccessible after installation.

This transducer must be mounted in a suitable end-enclosure.

Besides make sure to have a distance of minimum 30 mm between the primary terminals of the transducer and other neighboring components.

Main supply must be able to be disconnected.

Never connect or disconnect the external power supply while the primary circuit is connected to live parts.

Never connect the output to any equipment with a common mode voltage to earth greater than 30 V.

This transducer is a built-in device, not intended to be cleaned with any product. Nevertheless if the user must implement cleaning or washing process, validation of the cleaning program has to be done by himself.



ESD susceptibility

The product is susceptible to be damaged from an ESD event and the personnel should be grounded when handling it.

Do not dispose of this product as unsorted municipal waste. Contact a qualified recycler for disposal.



Underwriters Laboratory Inc. recognized component

### Absolute maximum ratings

Parameter	Symbol	Unit	Value
Maximum DC supply voltage = ( $U_p = 0 \text{ V}, 0.1 \text{ s}$ )	$\pm \hat{U}_{C \text{ max}}$	V	$\pm 33.6$
Maximum DC supply voltage = (working) ( $-40 \dots +85 \text{ }^\circ\text{C}$ )	$\pm U_{C \text{ max}}$	V	$\pm 26.4$
Electrostatic discharge voltage (HBM - Human Body Model)	$U_{\text{ESD HBM}}$	kV	4
Maximum DC common mode voltage	$U_{\text{HV}+} + U_{\text{HV}-}$ and $ U_{\text{HV}+} - U_{\text{HV}-} $	kV	$\leq 6.3$ $\leq U_{\text{PM}}$

Absolute maximum ratings apply at  $25 \text{ }^\circ\text{C}$  unless otherwise noted.  
 Stresses above these ratings may cause permanent damage.  
 Exposure to absolute maximum ratings for extended periods may degrade reliability.

### Environmental and mechanical characteristics

Parameter	Symbol	Unit	Min	Typ	Max	Comment
Ambient operating temperature	$T_A$	$^\circ\text{C}$	-40		85	
Ambient storage temperature	$T_{\text{Ast}}$	$^\circ\text{C}$	-50		90	
Equipment operating temperature class						EN 50155: OT6
Switch-on extended operating temperature class						EN 50155: ST0
Rapid temperature variation class						EN 50155: H1
Conformal coating type						EN 50155: PC2
Relative humidity	$RH$	%				Class 3K3 according to Table 1 of EN 60721-3-3
Shock & vibration categorie and class						EN 50155: 1B (EN 61373)
Mass	$m$	g		375		
Ingress protection rating				IP40		IEC 60529 (Indoor use)
Pollution degree					PD4	Insulation voltage accordingly
Altitude		$m$			2000 <sup>1)</sup>	
Impact rating				IK06		According to IEC 62262

**Note:** <sup>1)</sup> Insulation coordination at 2000 m.

### RAMS data

Parameter	Symbol	Unit	Min	Typ	Max	Comment
Useful life class						EN 50155: L4
Mean failure rate	$\bar{\lambda}$	$\text{h}^{-1}$		1/1827550		According to IEC 62380 $T_A = 45 \text{ }^\circ\text{C}$ ON: 20 hrs/day ON/OFF: 320 cycles/year $U_C = \pm 24 \text{ V}, U_P = 4000 \text{ V}$

## UL 347: Ratings and assumptions of certification

File # E315896 Volume: 1 Section: 3

### Standards

- CSA C22.2 No. 253 Medium-Voltage AC Contactors, Controllers, and Control Centers
- UL 347 Standards for Safety for Medium-Voltage AC Contactors, Controllers, and Control Centers.

### Conditions of acceptability

When installed in the end-use equipment, consideration shall be given to the following:

- 1 - *These devices must be mounted in a suitable end-use enclosure.*
- 2 - *The terminals have not been evaluated for field wiring.*
- 3 - *The rated Basic Insulation Level (BIL) is 20 kV for this device, after performing Impulse Withstand Tests. Additional testing will be required if a higher BIL rating is desired.*
- 4 - *For products rated more than 2500 V, the specific kit model "UL 347 isolator" shall be mounted to the DVM.*
- 5 - *The products have been evaluated for a maximum surrounding air temperature of 85 °C..*
- 6 - *Low voltage circuits are intended to be powered by a circuit derived from an isolating source (such as a transformer, optical isolator, limiting impedance or electro-mechanical relay) and having no direct connection back to the primary circuit (other than through the grounding means).*

### Marking

Only those products bearing the UL or UR Mark should be considered to be Listed or Recognized and covered under UL's Follow-Up Service. Always look for the Mark on the product.

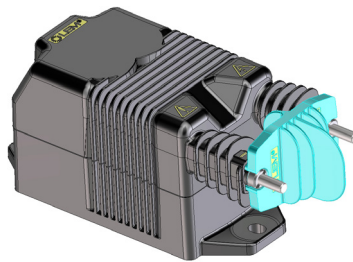

Assembly of UL 347 Isolator on primary studs.  
UL 347 Isolator, reference number 92.24.06.420.0 provided.

**Insulation coordination**

Parameter	Symbol	Unit	≤ Value	Comment
RMS voltage for AC insulation test, 50 Hz, 1 min	$U_d$	kV	12	
Impulse withstand voltage 1.2/50 $\mu$ s	$U_{Ni}$	kV	30	According to IEC 62497-1
Partial discharge RMS test voltage ( $q_m < 10$ pC)	$U_t$	V	5000	
Case material	-	-	V0	
Comparative tracking index	$CTI$		600	According to UL 94

**Between primary and secondary**

Clearance	$d_{Cl}$	mm	74	Shortest distance through air
Creepage distance	$d_{Cp}$	mm	101	Shortest path along device body
Application example RMS voltage line-to-neutral		V	1000	Reinforced insulation according to IEC 60664-1, IEC 61010-1 or IEC 62477-1 CAT III, PD2
Application example System voltage RMS		V	3600	Basic insulation according to IEC 61800-5-1 CAT III, PD2
Application example Rated insulation RMS voltage	$U_{Nm}$	V	4800	Basic insulation according to IEC 62497-1 CAT III, PD2, Rolling stock
Application example Rated insulation RMS voltage	$U_{Nm}$	V	3700	Reinforced insulation according to IEC 62479-1 CAT II, PD2

**Between primary and ground (fastening screw M6 head)**

Clearance	$d_{Cl}$	mm	45	Shortest distance through air
Creepage distance	$d_{Cp}$	mm	101	Shortest path along device body
Application example Rated insulation RMS voltage		V	1000	Reinforced insulation according to IEC 61010-1 CAT III, PD2

**Between secondary and ground (fastening screw M6 head)**

Clearance	$d_{Cl}$	mm	16	Shortest distance through air
Creepage distance	$d_{Cp}$	mm	24	Shortest path along device body
Application example Rated insulation RMS voltage		V	1000	Basic insulation according to IEC 61010-1 CAT III, PD2

**Electrical data DVM 2000-B**

At  $T_A = T_{Amin} \dots T_{Amax}$ ,  $\pm U_C = \pm 24$  V,  $R_M = 2$  k $\Omega$ , unless otherwise noted (see Min, Max, typ, definition paragraph in page 8).

Parameter	Symbol	Unit	Min	Typ	Max	Comment
Primary nominal DC voltage (continuous)	$U_{PNDC}$	V		2000		
Primary nominal AC RMS voltage (continuous)	$U_{PNAC}$	V		2000		
Primary voltage, measuring range	$U_{PM}$	V	-3000		3000	
Measuring resistance	$R_M$	$\Omega$	2000			
Secondary voltage	$U_S$	V		6.66		@ $U_{PNDC}$
DC supply voltage =	$U_C$	V	$\pm 13.5$	$\pm 24$	$\pm 26.4$	
DC current consumption =	$I_C$	mA		27		@ $U_C = \pm 24$ V at $U_p = 0$ V
				40		@ $U_C = \pm 15$ V at $U_p = 0$ V
Power consumption $U_p = 0$ V @ $U_C$	$P_C$	W		1.13		@ $U_C = \pm 24$ V
Power consumption $U_p = U_{PNDC}$ @ $U_C$	$P_C$	W		1.29		@ $U_C = \pm 24$ V
Inrush current						NA (EN 50155)
Interruptions on power supply voltage class						NA (EN 50155)
Supply change-over class						NA (EN 50155)
Rise time of $U_C$ (10 % ... 90 %)	$t_{rise}$	ms			100	
Total error	$\epsilon_{tot}$	%	-1		1	
Total error	$\epsilon_{tot}$	%	-0.5		0.5	@ 25 °C 100 % tested in production
				-9.0		9.0
Temperature variation of $U_{OE}$ referred to primary	$U_{OET}$	V			7.5	@ -25 °C ... 85 °C
				-7.5		
Electrical Offset voltage referred to primary	$U_{OE}$	V	-2.1		2.1	@ 25 °C 100 % tested in production
Sensitivity	$S$	mV/V		3.33		@ 25 °C
Sensitivity error	$\epsilon_S$	%	-0.3		0.3	@ 25 °C
Temperature variation of sensitivity error	$\epsilon_{ST}$	%	-0.5		0.5	referred to 25 °C
Linearity error	$\epsilon_L$	% of $U_{PM}$	-0.5		0.5	@ 25 °C $\pm 3000$ V range
RMS noise current 100 Hz ... 100 kHz referred to secondary	$U_{no}$	mV		2.4		@ 25 °C
Delay time @ 10 % of the final output value $U_{PN}$ step	$t_{D10}$	$\mu$ s		30		
Delay time @ 90 % of the final output value $U_{PN}$ step	$t_{D90}$	$\mu$ s		50	60	0 to 2000 V step, 6 kV/ $\mu$ s
Frequency bandwidth	$BW$	kHz		14		-3 dB
				8		-1 dB
Start-up time	$t_{start}$	ms		190	250	
Resistance of primary	$R_p$	M $\Omega$		25.1		
Total primary power loss @ $U_{PN}$	$P_p$	W		0.16		

**Electrical data DVM 4000-B**

 At  $T_A = T_{Amin} \dots T_{Amax}$ ,  $U_C = \pm 24$  V,  $R_M = 2$  k $\Omega$ , unless otherwise noted (see Min, Max, typ, definition paragraph in page 8).

Parameter	Symbol	Unit	Min	Typ	Max	Comment
Primary nominal DC voltage (continuous)	$U_{PNDC}$	V		4000		
Primary nominal AC RMS voltage (continuous)	$U_{PNAC}$	V		4000		
Primary voltage, measuring range	$U_{PM}$	V	-6000		6000	
Measuring resistance	$R_M$	$\Omega$	2000			
Secondary voltage	$U_S$	V		6.66		@ $U_{PNDC}$
DC supply voltage =	$U_C$	V	$\pm 13.5$	$\pm 24$	$\pm 26.4$	
DC current consumption =	$I_C$	mA		27		@ $U_C = \pm 24$ V at $U_p = 0$ V
				40		@ $U_C = \pm 15$ V at $U_p = 0$ V
Power consumption $U_p = 0$ V @ $U_C$	$P_C$	W		1.13		@ $U_C = \pm 24$ V
Power consumption $U_p = U_{PNDC}$ @ $U_C$	$P_C$	W		1.77		@ $U_C = \pm 24$ V
Inrush current						NA (EN 50155)
Interruptions on power supply voltage class						NA (EN 50155)
Supply change-over class						NA (EN 50155)
Rise time of $U_C$ (10 % ... 90 %)	$t_{rise}$	ms			100	
Total error	$\epsilon_{tot}$	%	-1		1	
Total error	$\epsilon_{tot}$	%	-0.5		0.5	@ 25 °C 100 % tested in production
Temperature variation of $U_{OE}$ referred to primary	$U_{OET}$	V	-18.0		18.0	
			-15.0		15.0	@ -25 °C ... 85 °C
Electrical Offset voltage referred to primary	$U_{OE}$	V	-4.2		4.2	@ 25 °C 100 % tested in production
Sensitivity	$S$	mV/V		1.66		@ 25 °C
Sensitivity error	$\epsilon_S$	%	-0.3		0.3	@ 25 °C
Temperature variation of sensitivity error	$\epsilon_{ST}$	%	-0.5		0.5	referred to 25 °C
Linearity error	$\epsilon_L$	% of $U_{PM}$	-0.5		0.5	@ 25 °C $\pm 6000$ V range
RMS noise current 100 Hz ... 100 kHz referred to secondary	$U_{no}$	mV		2.4		@ 25 °C
Delay time @ 10 % of the final output value $U_{PN}$ step	$t_{D10}$	$\mu$ s		30		
Delay time @ 90 % of the final output value $U_{PN}$ step	$t_{D90}$	$\mu$ s		50	60	0 to 4000 V step, 6 kV/ $\mu$ s
Frequency bandwidth	$BW$	kHz		14		-3 dB
				8		-1 dB
Start-up time	$t_{start}$	ms		190	250	
Resistance of primary	$R_p$	M $\Omega$		25.1		
Total primary power loss @ $U_{PN}$	$P_p$	W		0.64		

### Definition of typical, minimum and maximum values

Minimum and maximum values for specified limiting and safety conditions have to be understood as such as well as values shown in “typical” graphs.

On the other hand, measured values are part of a statistical distribution that can be specified by an interval with upper and lower limits and a probability for measured values to lie within this interval.

Unless otherwise stated (e.g. “100 % tested”), the LEM definition for such intervals designated with “min” and “max” is that the probability for values of samples to lie in this interval is 99.73 %.

For a normal (Gaussian) distribution, this corresponds to an interval between  $-3$  sigma and  $+3$  sigma. If “typical” values are not obviously mean or average values, those values are defined to delimit intervals with a probability of 68.27 %, corresponding to an interval between  $-\text{sigma}$  and  $+\text{sigma}$  for a normal distribution.

Typical, maximal and minimal values are determined during the initial characterization of the product.



Typical performance characteristics

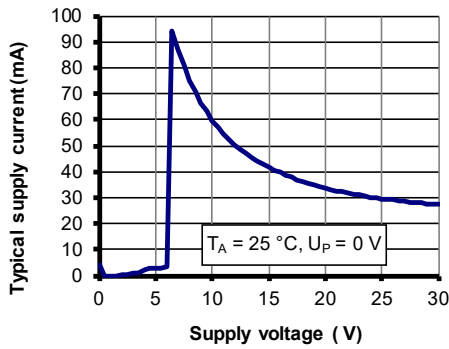

Figure 1: Supply current function of supply voltage

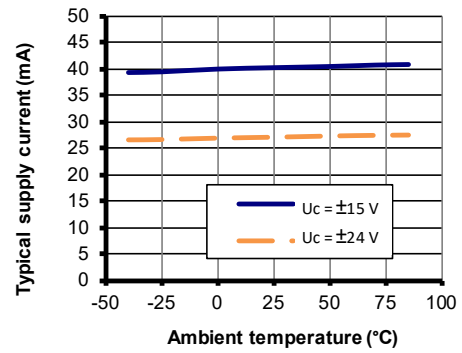

Figure 2: Supply current function of temperature

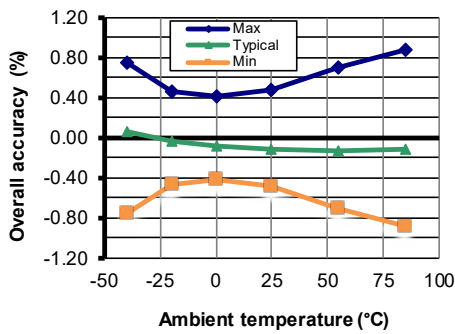

Figure 3: Total error in temperature

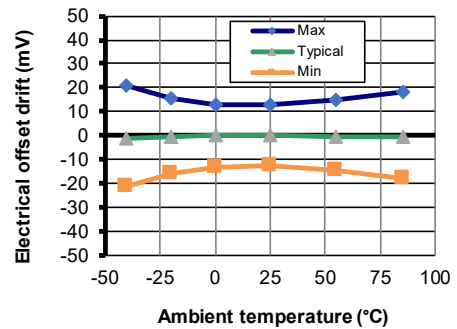

Figure 4: Electrical offset thermal drift

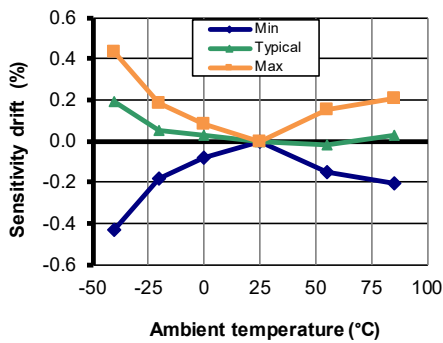

Figure 5: Sensitivity thermal drift

Typical performance characteristics

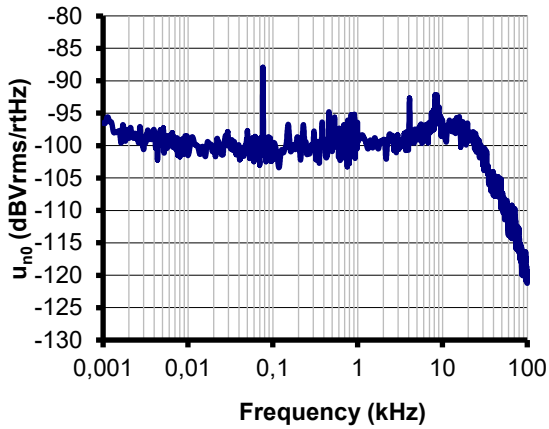

Figure 6: Typical output noise voltage spectral density  $u_{no}$  referred to secondary with  $R_M = 2 \text{ k}\Omega$

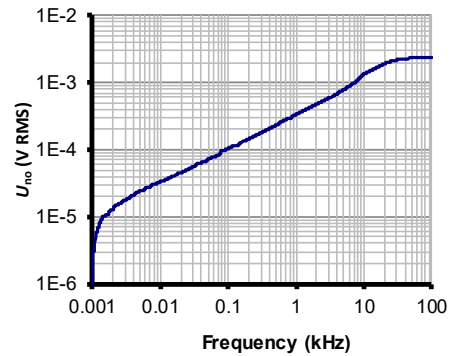

Figure 7: Typical total output RMS noise voltage  $U_{no}$  referred to secondary with  $R_M = 2 \text{ k}\Omega$

Figure 6 (output noise voltage spectral density) shows that there are no significant discrete frequencies in the output. Figure 7 confirms the absence of steps in the total output RMS noise voltage that would indicate discrete frequencies. To calculate the total output RMS noise in a frequency band  $f_1$  to  $f_2$ , the formula is:  
with  $U_{no}(f)$  read from figure 7 (typical, RMS value).

$$U_{no}(f_1 \text{ to } f_2) = \sqrt{U_{no}(f_2)^2 - U_{no}(f_1)^2}$$

Example:

What is the total output RMS noise from 10 to 1 kHz?  
Figure 7 gives  $U_{no}(10 \text{ Hz}) = 33 \text{ }\mu\text{V}$  and  $U_{no}(1 \text{ kHz}) = 336 \text{ }\mu\text{V}$ .

$$\sqrt{(336 \times 10^{-6})^2 - (33 \times 10^{-6})^2} = 334 \text{ }\mu\text{V}$$

Therefore, the total output RMS noise voltage is 334  $\mu\text{V}$ .

Typical performance characteristics

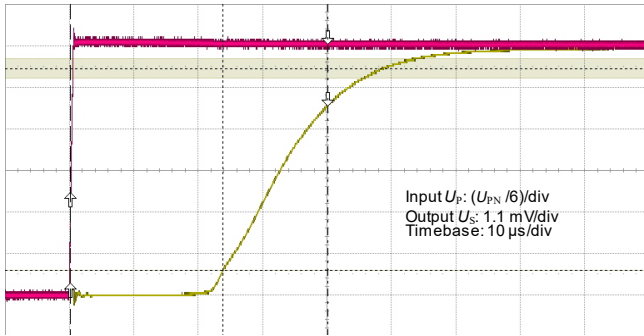

Figure 8: Typical step response (0 to  $U_{PN}$ )

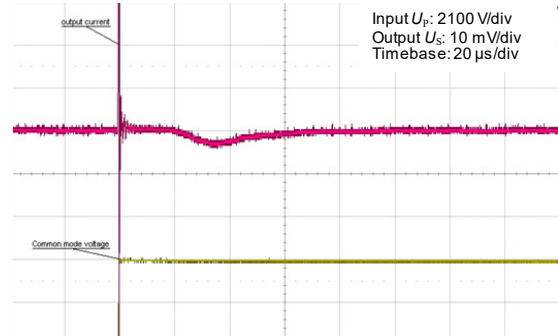

Figure 9: Detail of typical common mode perturbation (4200 V step with 6 kV/ $\mu$ s,  $R_M = 2$  k $\Omega$ )

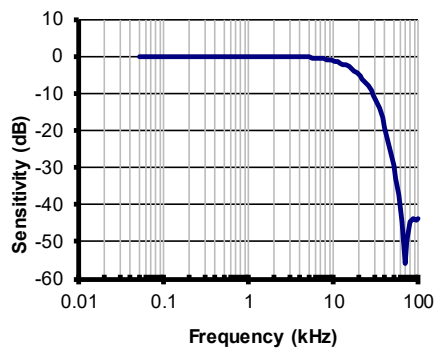

Figure 10: Sensitivity function of frequency

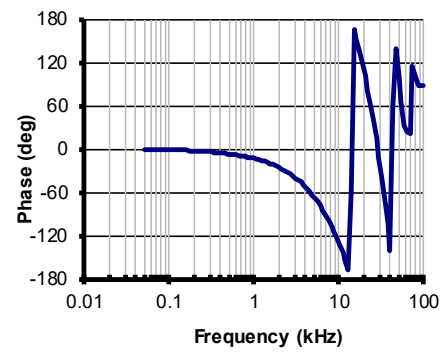

Figure 11: Phase shift function of frequency

## Terms and definitions

### Simplified transducer model

The static model of the transducer with current output at temperature  $T_A$  is:

$$U_s = S \cdot U_p \cdot (1 + \varepsilon)$$

In which (referred to primary):

$$\varepsilon \cdot U_p = U_{OE} + U_{OT} + \varepsilon_s \cdot U_p + \varepsilon_{sT} \cdot U_p + \varepsilon_L(U_{Pmax}) \cdot U_{Pmax}$$

- $U_p$  : primary voltage (V)
- $U_{Pmax}$  : maximum primary voltage applied to the transducer (V)
- $U_s$  : secondary voltage (V)
- $S$  : sensitivity of the transducer
- $TCS$  : temperature coefficient of  $S$
- $T_A$  : ambient operating temperature (°C)
- $U_{OE}$  : electrical offset voltage (V)
- $U_{OT}$  : temperature variation of  $U_{OE}$  (V)
- $\varepsilon_s$  : sensitivity error at 25 °C
- $\varepsilon_{sT}$  : thermal drift of  $S$
- $\varepsilon_L(U_{Pmax})$  : linearity error for  $U_{Pmax}$

This model is valid for primary voltage  $U_p$  between  $-U_p$  max and  $+U_p$  max only.

This is the absolute maximum error. As all errors are independent, a more realistic way to calculate the error would be to use the following formula:

$$\varepsilon = \sqrt{\sum_{i=1}^N \varepsilon_i^2}$$

### Total error referred to primary

The total error  $\varepsilon_{tot}$  is the error at  $\pm U_{PN}$ , relative to the rated value  $U_{PN}$ .

It includes all errors mentioned above

- the electrical offset  $U_{OE}$
- the sensitivity error  $\varepsilon_s$
- the linearity error  $\varepsilon_L$  (to  $U_{PN}$ ).

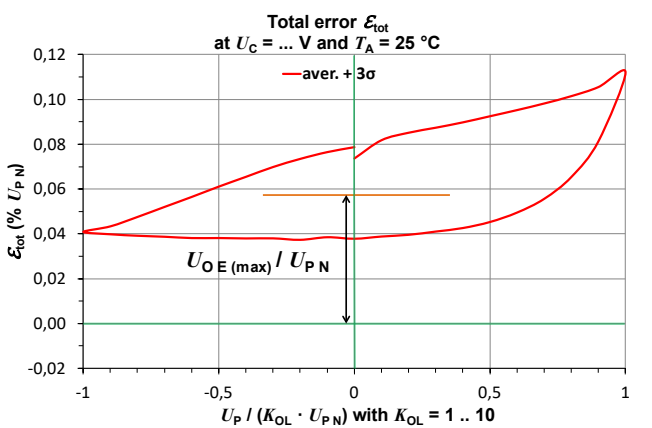
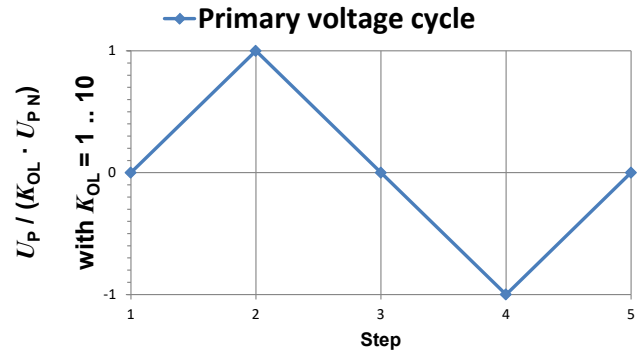

Figure 13: Total error  $\varepsilon_{tot}$

### Electrical offset referred to primary



$K_{OL}$ : Overload factor

Figure 14: voltage cycle used to measure the electrical offset (transducer supplied)

Using the voltage cycle shown in previous figure, the electrical offset voltage  $U_{OE}$  is the residual output referred to primary when the input voltage is zero.

The temperature variation  $U_{OT}$  of the electrical offset voltage

$$U_{OE} = \frac{U_{P(3)} + U_{P(5)}}{2}$$

$U_{OE}$  is the variation of the electrical offset from 25 °C to the considered temperature.

### Sensitivity and linearity

$$U_{OT}(T) = U_{OE}(T) - U_{OE}(25^\circ\text{C})$$

To measure sensitivity and linearity, the primary voltage (DC) is cycled from 0 to  $U_p$ , then to  $-U_p$  and back to 0 (equally spaced  $U_p/10$  steps). The sensitivity  $S$  is defined as the slope of the linear regression line for a cycle between  $\pm U_{PN}$ .

The linearity error  $\varepsilon_L$  is the maximum positive or negative difference between the measured points and the linear regression line, expressed in % of  $U_{PN}$ .

### Delay times

The delay time  $t_{D10}$  @ 10 % and the delay time  $t_{D90}$  @ 90 % with respect to the primary are shown in the next figure.

Both slightly depend on the primary current  $di/dt$ . They are measured at nominal current.

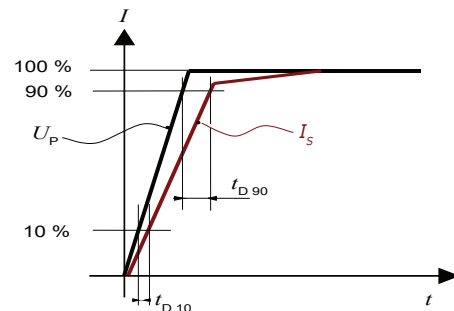
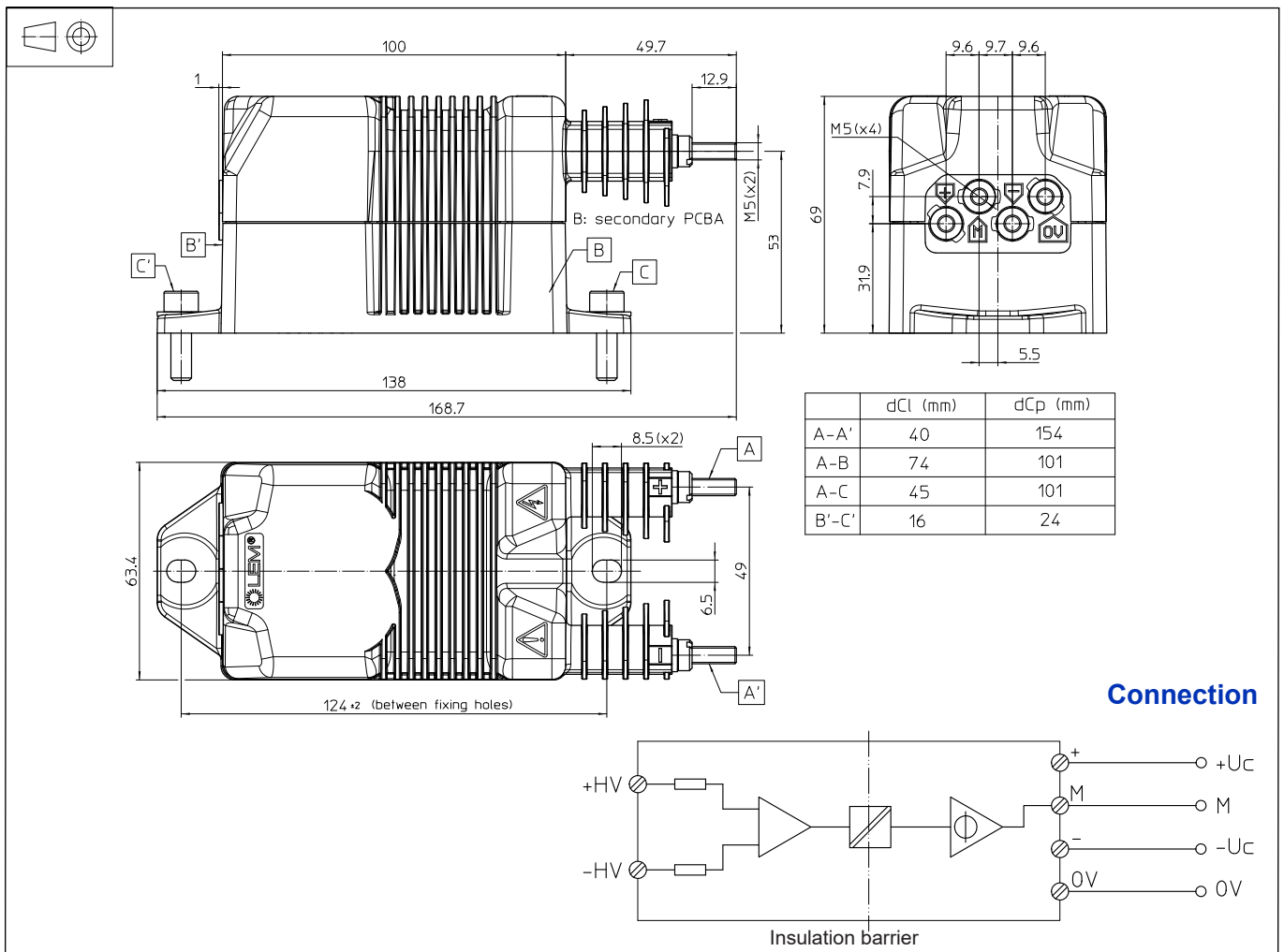
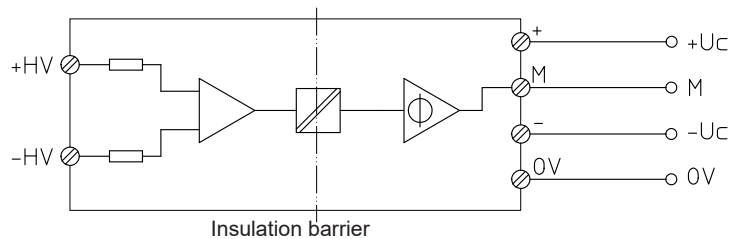

Figure 15: delay time  $t_{D10}$  @ 10 % and delay time  $t_{D90}$  @ 90 %.

**Dimensions (in mm)**

**Connection**

**Mechanical characteristics**

- General tolerance  $\pm 1$  mm
- Transducer fastening
  - 2 holes  $\varnothing 6.5$  mm
  - 2 M6 steel screws
  - Recommended fastening torque 5 N·m  $\pm 10$  %
- Connection of primary
  - 2 M5 threaded studs
  - Recommended fastening torque 2.2 N·m  $\pm 10$  %
- Connection of secondary
  - 4 M5 threaded studs (max screw length is 12 mm)
  - Recommended fastening torque 2.2 N·m  $\pm 10$  %

**Remarks**

- $I_s$  is positive when  $U_{HV+} - U_{HV-} > 0$  V.
- The secondary cables also have to be routed together all the way.
- Installation of the transducer must be done unless otherwise specified on the datasheet, according to LEM Transducer Generic Mounting Rules. Please refer to LEM document N°ANE120504 available on our Web site: <https://www.lem.com/en/file/3137/download/>

Note: Additional information available on request.

单击下面可查看定价，库存，交付和生命周期等信息

[>>LEM\(莱姆\)](#)