

# ART series

Ref: ART-B22-D125/SP25

Flexible clip-around Rogowski coil for the electronic measurement of AC current with galvanic separation between the primary circuit (power) and the secondary circuit (measurement). The patented Perfect Loop Technology dramatically reduces both the error due to the position of the measured conductor within the aperture, and the error due to the proximity of external conductors.

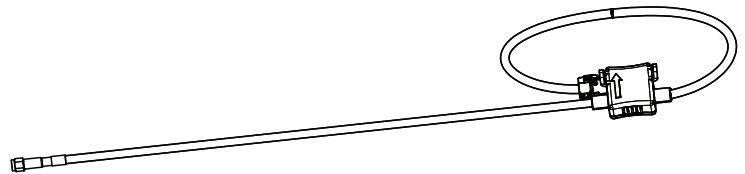

## Features

- The most accurate coil of the market, Class 0.5 (IEC 61869-10)
- Very low positioning error
- Small external fields influence
- Low sensitivity 22.5 mV/kA to have a very thin coil for indoor application
- Electrostatic shield included for better common mode rejection of the integrator
- Protection degree IP57
- Ø 125 mm sensing aperture
- Cable length: 3 m.

## Special feature

- Cable end equipped with SMA male connector.

## Advantages

- Thin, flexible, and light weight solution
- Very good accuracy
- Does not saturate with overcurrent and short circuit currents
- Excellent immunity to electromagnetic interferences
- Fast and easy installation.

## Applications

- Secondary distribution substations
- Distribution transformer monitoring
- Phasor Measurement Units (PMU)
- Commercial and industrial buildings
- Metering and sub-metering
- Demand response (DR)
- Distribution system equipment.

## Standards

- IEC 61010-1: 2010
- IEC 61010-2-32: 2012
- IEC 61869-10: 2017 <sup>1)</sup>
- UL 61010-1: 2012.

## Application Domains

- Industrial
- Smart Grid.

Note: <sup>1)</sup> Performance standards: ART-B22 only partially fulfills this standard as a Rogowski coil has fundamental differences compared to current transformers.

## Safety



If the device is used in a way that is not specified by the manufacturer, the protection provided by the device may be compromised. Always inspect the current sensor unit and connecting cable before using this product and do not use it if damaged (for example, if the contrasting color of the flexible rope is visible).

Mounting assembly shall guarantee the maximum primary busbar temperature, fulfill clearance and creepage distance, minimize electric and magnetic coupling, and unless otherwise specified can be mounted in any orientation.

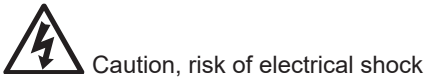

This current sensor must be used in electric/electronic equipment with respect to applicable standards and safety requirements in accordance with the manufacturer's operating specifications.

This current sensor is intended for use in an electrical installation with restricted access.

Therefore, in normal operation, it is not accessible. For installation or in maintenance phases, it is accessible only to qualified person.

It is intended to be connected onto SELV equipment input, of up to 30 V RMS.

When operating, certain parts of the current sensor can carry hazardous voltages (e.g. primary busbar, power supply).

De-energize all circuits and hazardous live parts before installing the product.

All installations, maintenance, servicing operations and use must be carried out by trained and qualified personnel practicing applicable safety precautions.

If the current sensor is used in a manner not specified by the manufacturer, the protection provided by the equipment may be impaired.

Ignoring this warning can lead to injury and/or cause serious damage.

This current sensor is a built-in device, whose hazardous live parts must be inaccessible after installation.

This current sensor must be mounted in a suitable end-enclosure.

Use caution during installation, use and uninstalling of this product; high voltages and currents, high temperature (above 70 °C) may be present inside the electrical equipment.

Use personal protective equipment (clothes, gloves, ...).

This current sensor is a built-in device, not intended to be cleaned with any product. Nevertheless if the user must implement cleaning or washing process, validation of the cleaning program has to be done by himself.

Do not dispose of this product as unsorted municipal waste. Contact a qualified recycler for disposal.

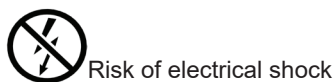

Do not apply around or remove from uninsulated hazardous live conductors which may result in electric shock, electric burn or arc flash.



Equipment protected throughout by double insulation or reinforced insulation.



ESD susceptibility

The product is susceptible to be damaged from an ESD event and the personnel should be grounded when handling it.

**Absolute maximum ratings**

Parameter	Symbol	Unit	Value
Maximum secondary voltage	$U_{S\max}$	V	30
Maximum primary conductor temperature	$T_{B\max}$	°C	105

Stresses above these ratings may cause permanent damage.  
Exposure to absolute maximum ratings for extended periods may degrade reliability.

**UL 61010-1: Ratings and assumptions of certification**

File # E330077 , Vol.D1

**Standards**

- UL 61010-1, Third Edition, May 11, 2012, Revised April 29, 2016
- CAN/CSA-C22.2 No. 61010-1-12, 3rd Edition, Revision dated April 29, 2016
- IEC 61010-2-032: 2012 (Third Edition), UL 61010-2-032 (IEC 61010-2-032:2012).

**Ratings**

Rated insulation voltage AC 1000 V, 50/60 Hz, CAT III, 2000 A.

**Engineering conditions of acceptability**

When installed in an end-product, consideration must be given to the following:

- ART series has been investigated as Type B current sensors according IEC 61010-2-032 3rd ed.
- The devices have been evaluated for overvoltage category III and pollution degree 2 environment use only.

For ART series, the need for the following shall be considered in the end-product:

- Markings and documentation that comply with Clause 5.
- The following tests shall be performed in the end-product evaluation: Dielectric Strength.
- The unit is considered acceptable for use in a max ambient of 80 °C for ART series.
- A suitable enclosure shall be provided in the end-use application.
- The terminals have not been evaluated for field wiring.
- Primary conductor or busbar temperature should never exceed 100 °C.

**Insulation coordination**

Parameter	Symbol	Unit	≤ Value	Comment
RMS voltage for AC insulation test, 50 Hz, 1 min	$U_d$	kV	7.4	
Impulse withstand voltage 1.2/50 $\mu$ s	$U_{Ni}$	kV	12.8	
Partial discharge RMS test voltage ( $q_m < 10$ pC)	$U_t$	kV	1.65	According to IEC 60664- 1
Clearance (pri. - sec.)	$d_{Cl}$	mm	> 16	Shortest distance through air
Creepage distance (pri. - sec.)	$d_{Cp}$	mm	> 16	Shortest path along device body
Case material	-	-	V0	According to UL 94
Comparative tracking index	$CTI$		600	
Application example RMS voltage line-to-neutral		V	1000	Basic insulation according to IEC 61010-1 CAT IV, PD2
Application example RMS voltage line-to-neutral		V	1000	Reinforced insulation according to IEC 61010-1 CAT III, PD2

**Environmental and mechanical characteristics**

Parameter	Symbol	Unit	Min	Typ	Max	Comment
Ambient operating temperature	$T_A$	°C	-40		80	
Ambient storage temperature	$T_{A\ st}$	°C	-40		80	
Relative humidity (non-condensing)	$RH$	%	0		90	
Altitude above sea level		m			2000	
Mass $\varnothing$ 125	$m$	g		200		Cable length: 3 m

**Electrical data ART-B22-D125/SP25**

 At  $T_A = 25\text{ °C}$ ,  $R_L = 10\text{ k}\Omega$ , unless otherwise noted.

Parameter	Symbol	Unit	Min	Typ	Max	Comment
Rated primary current	$I_{Pr}$	A				Not applicable <sup>1)</sup>
Rated short-time thermal current	$I_{th}$	kA		300		@ 50 Hz <sup>2)</sup>
Rated transformation ratio	$k_r$	kA/V		44.44		@ 50 Hz
Rated frequency	$f_r$	Hz		50/60		
Secondary voltage	$U_s$	mV		22.5		@ 50 Hz, $I_p = 1\text{ kA}$
Mutual inductance	$M$	nH		71.98		
Temperature coefficient of $M$	$TCM$	ppm/k		$\pm 30$		
Frequency bandwidth (-3 dB)	$BW$	kHz		420		<sup>3)</sup> Cable length: 3 m
Phase displacement <sup>4)</sup> @ 50/60 Hz	$\Delta\phi$	°		0.004		<sup>3)</sup>
Coil inductance	$L_s$	$\mu\text{H}$		258		
Coil resistance	$R_s$	$\Omega$		81		
Ratio error (centered)	$\varepsilon$	%	-0.5		0.5	Class 0.5 accuracy according to IEC 61869-10
Ratio error (all positions)	$\varepsilon$	%	-0.75		0.75	<sup>5)</sup> Including positioning error
Linearity error	$\varepsilon_L$	%		None		
Error due to magnetic field of external conductor current	$\varepsilon_{I_{ext}}$	%		$\pm 0.2$	$\pm 0.4$	<sup>6)</sup>

- Notes:**
- <sup>1)</sup> The Rogowski coil can measure any primary current as there is no saturation effect.
  - <sup>2)</sup> Not tested given that in the worst case (load = 0 Ohm i.e. short circuit on the output) the peak dissipated power remains low (< 2 Watts).
  - <sup>3)</sup> Frequency bandwidth and phase shift modeling schematic can be provided on request.
  - <sup>4)</sup> Referring to the main phase offset of 90 ° (a Rogowski coil is a derivative current transducer).
  - <sup>5)</sup> Considering a primary conductor of at least  $\varnothing 15\text{ mm}$ , perpendicular and on contact with the Rogowski coil.
  - <sup>6)</sup> Considering an external conductor of at least  $\varnothing 15\text{ mm}$  the same current level than internal conductor, perpendicular and on contact with the Rogowski coil.

**Definition of typical, minimum and maximum values**

Minimum and maximum values for specified limiting and safety conditions have to be understood as such as well as values shown in "typical" graphs.

On the other hand, measured values are part of a statistical distribution that can be specified by an interval with upper and lower limits and a probability for measured values to lie within this interval.

Unless otherwise stated (e.g. "100 % tested"), the LEM definition for such intervals designated with "min" and "max" is that the probability for values of samples to lie in this interval is 99.73 %.

For a normal (Gaussian) distribution, this corresponds to an interval between -3 sigma and +3 sigma. If "typical" values are not obviously mean or average values, those values are defined to delimit intervals with a probability of 68.27 %, corresponding to an interval between -sigma and +sigma for a normal distribution.

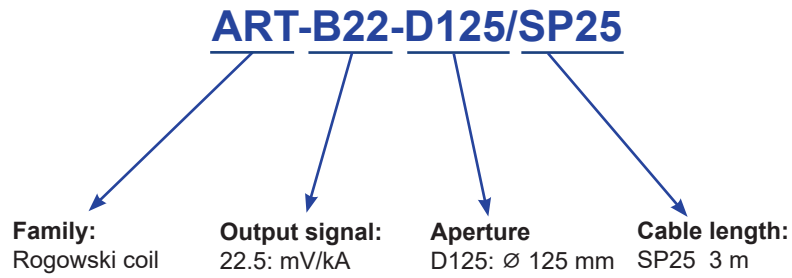

Typical, minimum and maximum values are determined during the initial characterization of the product.

Name and codification

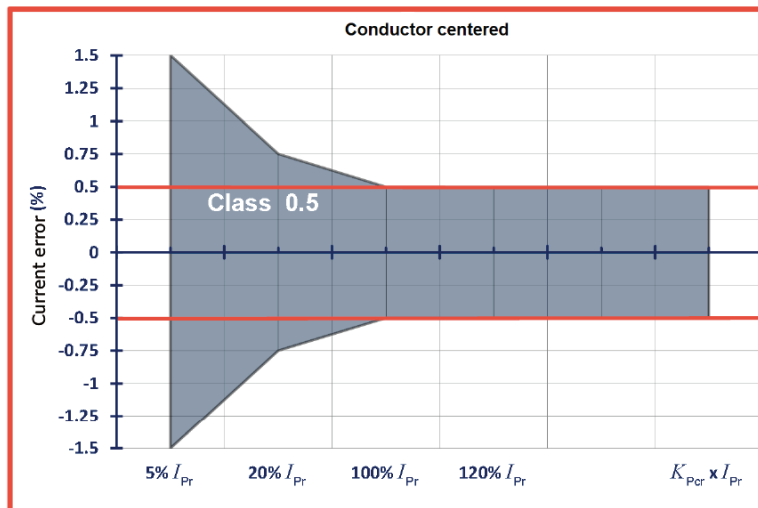

Accuracy class according to IEC 61869-10



-  Accuracy class limit of IEC 61869-10
-  Accuracy class limit of ART-B22 Rogowski

## Terms and definitions

### Rated transformation ratio $k_r$

$k_r$  is the ratio between the primary current  $I_p$  and the secondary voltage  $U_s$ .

$$k_r = \frac{I_p}{U_s}$$

### Ratio error $\varepsilon$

The current ratio error, expressed as a percentage, is defined by the formula:

$$\varepsilon = \frac{k_r U_s - I_p}{I_p} \times 100 \%$$

Where:

- $k_r$ : is the rated transformation ratio
- $I_p$ : is the actual primary current
- $U_s$ : is the actual secondary voltage when  $I_p$  is flowing

### Phase displacement $\Delta\varphi$

The  $\Delta\varphi$  is the difference in phase between the primary current and the ideal secondary voltage phasors. The direction of the phasors being that the angle is 90 ° (leading) for an ideal Rogowski coil.

The phase displacement is said to be positive when the secondary voltage phasor leads the primary current phasor.

### Linearity error $\varepsilon_L$

The linearity error  $\varepsilon_L$  is the maximum positive or negative difference between the measured points and the linear regression line, expressed as a percentage of  $I_{pr}$ .

### Rated short-time thermal current $I_{th}$

Maximum value of the primary current which the Rogowski will withstand for a specified short time without suffering harmful effects.

### Crosstalk error $\varepsilon_{XT}$

The crosstalk error defines how an external current passing in a close proximity to the product influences its performance. The crosstalk error expressed in percentage is given by the formula:

$$\varepsilon_{XT} = \frac{S_{XT} - S_{ref}}{S_{ref}} \times 100 \%$$

Where:

- $S_{ref}$ : is the sensitivity of the product measured in the center
- $S_{XT}$ : is the sensitivity of the product measured with an external conductor of at least 15 mm and with the same current level than internal conductor, perpendicular and in contact with the Rogowski coil.

Dimensions (in mm)

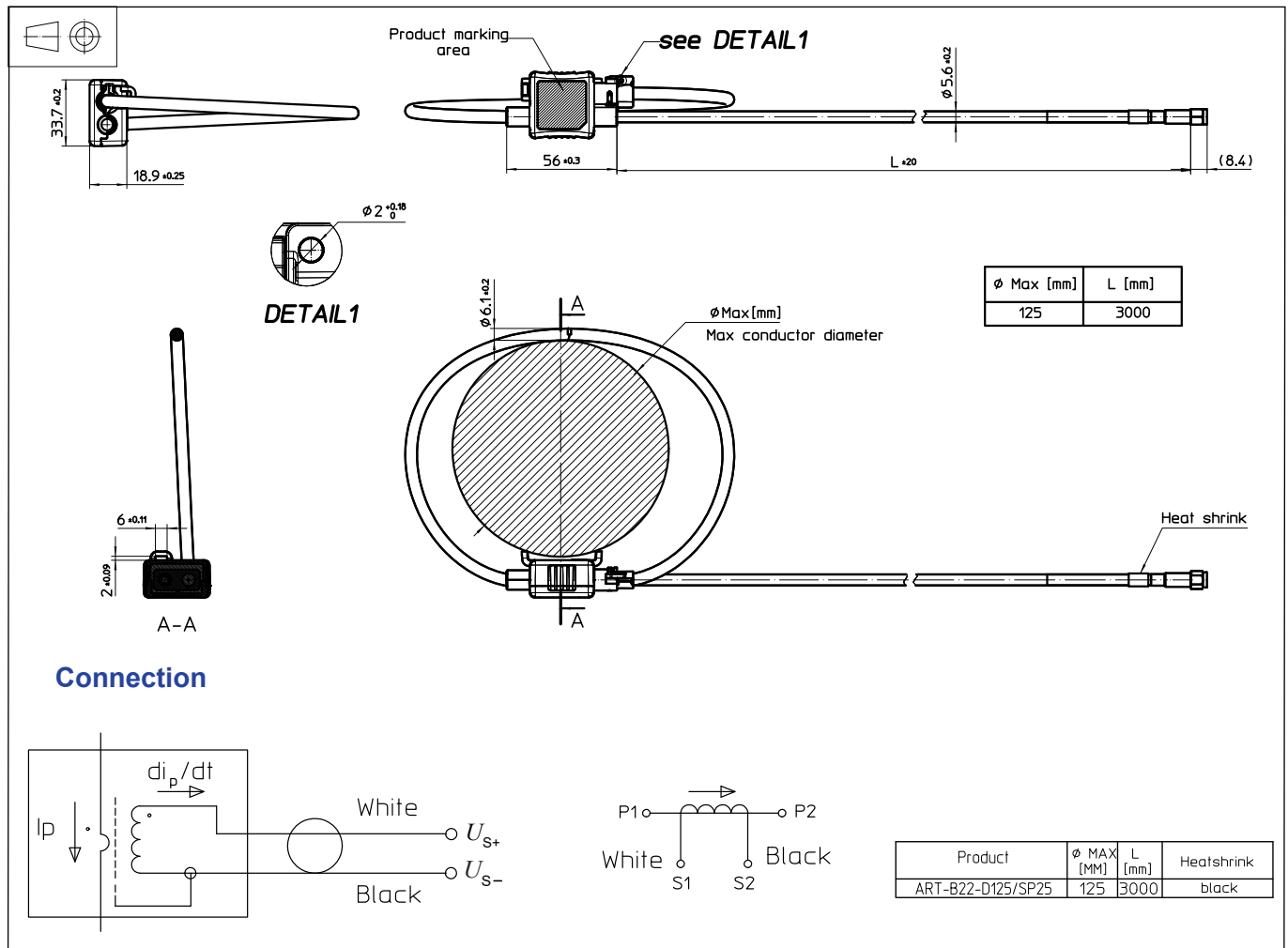

Mechanical characteristics

- General tolerance ±1 mm
- Output cable length 3 m
- Termination SMA male
- Cable tie maximum effort 50 N

Remarks

- $U_s = U_{s+} - U_{s-}$  is positive when an increasing primary current  $di/dt$  flows in the direction of the arrow.
- Due to low positioning error ( $\epsilon_{pos}$ ), the device does not need to be physically fastened around the primary conductor. Should the device be secured, make sure no mechanical stress is applied to the coil itself.
- This product is not intended for outdoor use.
- Installation of the transducer must be done unless otherwise specified on the datasheet, according to LEM Transducer Generic Mounting Rules. Please refer to LEM document N°ANE120504 available on our Web site: <https://www.lem.com/en/file/3137/download/>.



单击下面可查看定价，库存，交付和生命周期等信息

[>>LEM\(莱姆\)](#)