

# Voltage Transducer DVC 1000-UI

$U_{PN} = 1000\text{ V}$

For the electronic measurement of voltage: DC, AC ( $U_p \geq 0\text{ V}$ ), pulsed..., with galvanic separation between the primary and the secondary circuit.



## Features

- Unipolar and insulated measurement from 0 to 1000 V
- 4-20 mA instantaneous output (unipolar power supply)
- Panel and DIN rail mounting
- Push-in connections
- Built-in device
- Ingress protection rating IP 20.

## Advantages

- Low consumption and low losses
- Compact design
- Very low sensitivity to common mode voltage variations
- Excellent accuracy (offset, sensitivity, linearity)
- Fast delay time
- Low temperature drift
- High immunity to external interferences.

## Applications

- AC variable speed and servo motor drives
- Static converters for DC motor drives
- Battery supplied applications
- Uninterruptible Power Supplies (UPS)
- Power supplies for welding applications
- Single or three phase inverters
- Auxiliary converters
- Substations.

## Standards

- EN 50155: 2021
- EN 50121-3-2: 2016
- IEC 62497-1: 2010
- IEC 61000-6-2: 2016
- IEC 61000-6-4: 2016
- IEC 61800-3: 2005
- IEC 61010-1: 2010
- IEC 61800-5-1: 2007
- IEC 62109-1: 2010
- UL 508: 2018.

## Application Domain

- Industrial or Railway (fixed installations and onboard).

## Safety



Caution

If the device is used in a way that is not specified by the manufacturer, the protection provided by the device may be compromised. Always inspect the electronics unit and connecting before using this product and do not use it if damaged. Mounting assembly shall guarantee the maximum primary conductor temperature, fulfill clearance and creepage distance, minimize electric and magnetic coupling, and unless otherwise specified can be mounted in any orientation.



Caution, risk of electrical shock

This transducer must be used in limited-energy secondary circuits SELV according to IEC 61010-1, in electric/electronic equipment with respect to applicable standards and safety requirements in accordance with the manufacturer's operating specifications.

Use caution during installation and use of this product; certain parts of the module can carry hazardous voltages (e.g. power supply, primary conductor).

Ignoring this warning can lead to injury and or/or cause serious damage.

All installations, maintenance, servicing operations and use must be carried out by trained and qualified personnel practicing applicable safety precautions.

This transducer is a build-in device, whose hazardous live parts must be inaccessible after installation.

This transducer must be mounted in a suitable end-enclosure.

Besides make sure to have a distance of minimum 30mm between the primary terminals of the transducer and other neighboring components.

Main supply must be able to be disconnected.

Never connect or disconnect the external power supply while the primary circuit is connected to live parts.

Never connect the output to any equipment with a common mode voltage to earth greater than 30V.

Always wear protective clothing and gloves if hazardous live parts are present in the installation where the measurement is carried out.

This transducer is a built-in device, not intended to be cleaned with any product. Nevertheless if the user must implement cleaning or washing process, validation of the cleaning program has to be done by himself.



ESD susceptibility

The product is susceptible to be damaged from an ESD event and the personnel should be grounded when handling it.

Do not dispose of this product as unsorted municipal waste. Contact a qualified recycler for disposal.



Underwriters Laboratory Inc. recognized component.

### Absolute maximum ratings

Parameter	Symbol	Unit	Value
Maximum DC supply voltage = ( $U_p = 0$ V, 0.1 s)	$\hat{U}_{C \max}$	V	28
Maximum DC supply voltage = (working) (- 40 ... + 85 °C)	$U_{C \max}$	V	25.2
Electrostatic discharge voltage (HBM - Human Body Model)	$U_{ESD \text{ HBM}}$	kV	4
Maximum DC common mode voltage	$U_{HV+} + U_{HV-}$ and $ U_{HV+} - U_{HV-} $	kV	≤ 1.5

Absolute maximum ratings apply at 25 °C unless otherwise noted.  
Stresses above these ratings may cause permanent damage.  
Exposure to absolute maximum ratings for extended periods may degrade reliability.

### Environmental and mechanical characteristics

Parameter	Symbol	Unit	Min	Typ	Max	Comment
Ambient operating temperature	$T_A$	°C	-40		85	
Ambient storage temperature	$T_{A \text{ st}}$	°C	-50		90	
Equipment operating temperature class						EN 50155: OT6
Switch-on extended operating temperature class						EN 50155: ST0
Rapid temperature variation class						EN 50155: H2
Conformal coating type						EN 50155: PC2
Relative humidity	$RH$	%			95	
Shock & vibration categorie and class						EN 50155: 1B, (EN 61373)
Mass	$m$	g		57		
Ingress protection rating				IP20		IEC 60529 (Indoor use)
Altitude		m			2000 <sup>1)</sup>	
Pollution degree					PD3 <sup>2)</sup>	Insulation voltage accordingly

**Note(s):**

<sup>1)</sup> Insulation coordination at 2000 m

<sup>2)</sup> PD2 max accordingly to UL 508

### RAMS data

Parameter	Symbol	Unit	Min	Typ	Max	Comment
Useful life class						EN 50155: L4
Mean failure rate	$\bar{\lambda}$	h <sup>-1</sup>		1/1029866		According to IEC 62380 $T_A = 45$ °C ON: 20 hrs/day ON/OFF: 320 cycles/year $U_C = 15 \dots 24$ V, $U_p = 1000$ V

## UL 508: Rating and assumptions of certification

File # E189713 Volume: 2 Section: 16

### Standards

- Canadian Standard for industrial Control Equipment CSA C22.2 No. 14-18
- US Standard for Industrial Control Equipement UL 508

### Conditions of acceptability

When installed in the end-use equipment, consideration shall be given to the following:

1. Models DVC 1000-UI are intended to be mounted on a DIN rail or a mounting plate.
2. The terminals have not been evaluated for field wiring.
3. Low voltage control circuit shall be supplied by an isolating source (such as a transformer, optical isolator, limiting impedance or electro-mechanical relay).
4. These devices are intended to be mounted in an ultimate enclosure.
5. The products have been evaluated for a maximum surrounding air temperature of 85 °C.
6. These devices are intended to be installed in a pollution degree 2 max.

### Marking

Only those products bearing the UL or UR Mark should be considered to be Listed or Recognized and covered under UL's Follow-Up Service. Always look for the Mark on the product.

**Insulation coordination**

Parameter	Symbol	Unit	≤ Value	Comment
RMS voltage for AC insulation test at 50 Hz	$U_d$	kV	4.26	Type test: 1mn Routine test: 10s (100 % tested in prod.) Both tests according to IEC 62497-1
Impulse withstand voltage 1.2/50 $\mu$ s	$U_{Ni}$	kV	7.84	According to IEC 62497-1
Partial discharge RMS test voltage ( $q_m < 10$ pC)	$U_t$	V	1650	According to 61800-5-1
Case material	-	-	V0	According to UL 94
Comparative tracking index	$CTI$		600	

**Between primary and secondary**

Maximum RMS insulation voltage <sup>1)</sup>			1000 600 300	CAT I & II CAT III CAT IV
Clearance	$d_{Cl}$	mm	9.0	Shortest distance through air
Creepage distance	$d_{Cp}$	mm	9.0	Shortest path along device body
Application example RMS voltage line-to-neutral		V	600	Basic insulation according to IEC 61010-1, CAT III, PD2
Application example RMS voltage line-to-neutral		V	300	Reinforced insulation according to IEC 61010-1, CAT III, PD2
Application example System voltage RMS		V	600	Basic insulation according to IEC 61800-5-1, IEC 62109-1 CAT III, PD2
Application example System voltage RMS		V	600	Reinforced insulation according to IEC 61800-5-1, IEC 62109-1 CAT III, PD2
Application example Rated insulation RMS voltage		V	600	Basic insulation according to IEC 62497-1 CAT III, PD2
Application example Rated insulation RMS voltage	$U_{Nm}$	V	500	Reinforced insulation according to IEC 62497-1, CAT III, PD2
Operating voltage		V	1000	Insulation according to UL 508, CAT II, PD2

**Between primary and ground**

Clearance	$d_{Cl}$	mm	9.8	Shortest distance through air
Creepage distance	$d_{Cp}$	mm	9.8	Shortest path along device body
Application example Rated insulation RMS voltage		V	300	Reinforced insulation according to IEC 61010-1, CAT III, PD2

**Between secondary and ground**

Clearance	$d_{Cl}$	mm	8.7	Shortest distance through air
Creepage distance	$d_{Cp}$	mm	8.7	Shortest path along device body
Application example Rated insulation RMS voltage		V	300	Reinforced insulation according to IEC 61010-1, CAT III, PD2

Note:<sup>1)</sup> Electronic board limitation

**Electrical data**

At  $T_A = T_{Amin} \dots T_{Amax}$ ,  $U_C = 20 \text{ V}$ ,  $R_M = 100 \Omega$ , unless otherwise noted (see Min, Max, typ, definition paragraph in [page 6](#)).

Parameter	Symbol	Unit	Min	Typ	Max	Comment
Primary nominal DC voltage (continuous)	$U_{PNDC}$	V	0		1000	
Measuring resistance	$R_M$	$\Omega$	0			see derating on <a href="#">figure 1</a>
Secondary nominal direct current (continuous)	$I_{SND C}$	mA	4		20	full primary voltage range
Secondary current limit	$I_{SL}$	mA	0.5		21	see <a href="#">figure 2</a>
DC supply voltage ==	$U_C$	V	15	20	24	+5 % / -7 % on voltage range
DC current consumption ==	$I_C$	mA		22 21		$U_C = 24 \text{ V}$ , $U_P = 0 \text{ V@ } 25 \text{ }^\circ\text{C}$ $U_C = 15 \text{ V}$ , $U_P = 0 \text{ V@ } 25 \text{ }^\circ\text{C}$
Inrush current						NA (EN 50155)
Interruptions on power supply voltage class						NA (EN 50155)
Supply change-over class						NA (EN 50155)
Power consumption $U_P = 0 \text{ V @ } U_C$	$P_C$	W		0.53		@ 24 V
Power consumption $U_P = U_{PNDC} @ U_C$	$P_C$	W		1.00		@ 24 V
Rise time of $U_C$ (10 % ... 90 %)	$t_{rise}$	ms			100	
Total error	$\epsilon_{tot}$	%	-1.7		1.7	
Total error	$\epsilon_{tot}$	%	-1		1	@ 25 °C, 100 % tested in production
Temperature variation of $U_O$ referred to primary	$U_{OET}$	V	-3.00		3.00	referred to 25 °C
Electrical offset voltage referred to primary	$U_{OE}$	V	-6.00		6.00	@ 25 °C, 100 % tested in production
Sensitivity	$S$	$\mu\text{A/V}$		16		
Sensitivity error	$\epsilon_S$	%	-1		1	@ 25 °C
Temperature variation of sensitivity error	$\epsilon_{ST}$	%	-0.4		0.4	referred to 25 °C
Linearity error	$\epsilon_L$	% of $U_{PN}$	-0.2		0.2	@ 25 °C, 0-1000 V range
RMS noise voltage 100 Hz ... 100 kHz referred to primary	$U_{no}$	mV		1000		
Delay time @ 10 % of the final output value $U_{PN}$ step	$t_{D10}$	$\mu\text{s}$		5		
Delay time @ 90 % of the final output value $U_{PN}$ step	$t_{D90}$	$\mu\text{s}$		17		
Frequency bandwidth (-3 dB) (-1 dB)	$BW$	kHz		35 19		
Start-up time	$t_{start}$	ms		20		
Resistance of primary circuit	$R_P$	M $\Omega$		12.6		
Total primary power loss @ $U_{PN}$	$P_P$	W		0.08		

### Definition of typical, minimum and maximum values

Minimum and maximum values for specified limiting and safety conditions have to be understood as such as well as values shown in “typical” graphs.

On the other hand, measured values are part of a statistical distribution that can be specified by an interval with upper and lower limits and a probability for measured values to lie within this interval.

Unless otherwise stated (e.g. “100 % tested”), the LEM definition for such intervals designated with “min” and “max” is that the probability for values of samples to lie in this interval is 99.73 %.

For a normal (Gaussian) distribution, this corresponds to an interval between  $-3$  sigma and  $+3$  sigma. If “typical” values are not obviously mean or average values, those values are defined to delimit intervals with a probability of 68.27 %, corresponding to an interval between  $-\text{sigma}$  and  $+\text{sigma}$  for a normal distribution.

Typical, maximal and minimal values are determined during the initial characterization of the product.

Typical performance characteristics

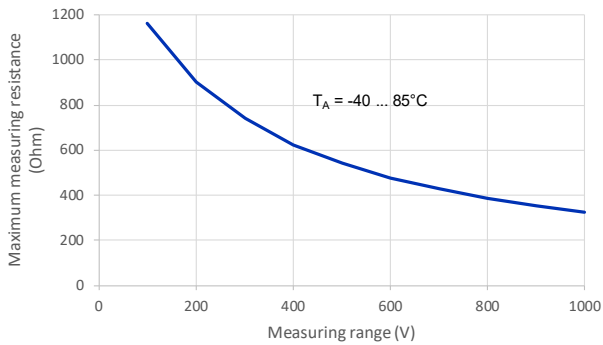

Figure 1: Maximum measuring resistance

$$R_{M\max} = \frac{1625000}{4 \times U_p + 1000} \Omega$$

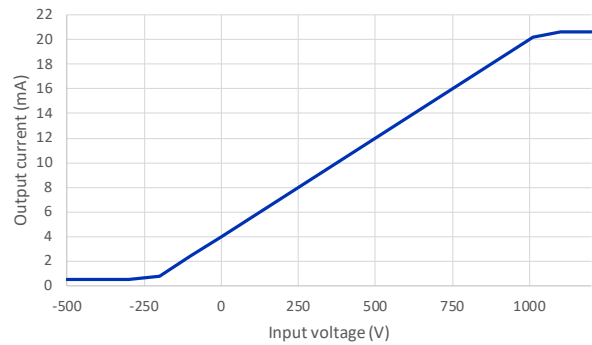

Figure 2: Output secondary current

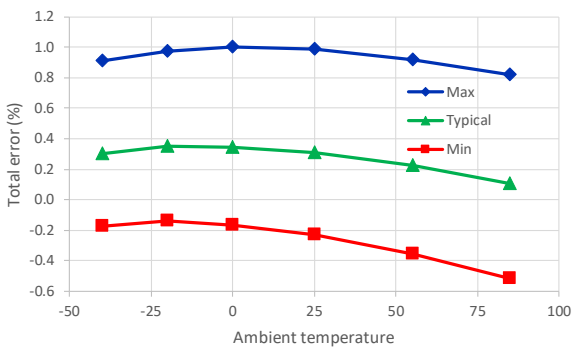

Figure 3: Total error in temperature

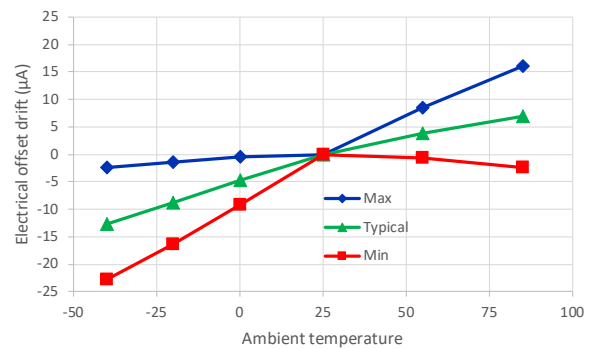

Figure 4: Electrical offset thermal drift

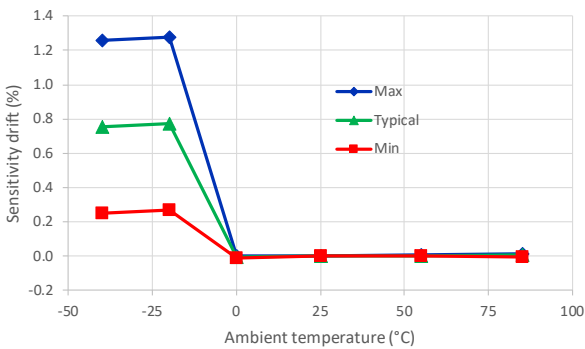

Figure 5: Sensitivity thermal drift

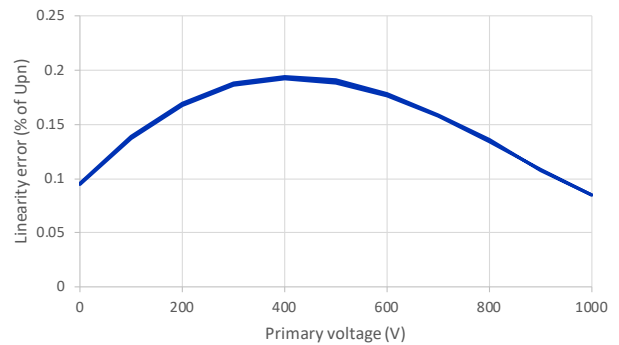

Figure 6: Typical linearity error at 25 °C



Typical performance characteristics

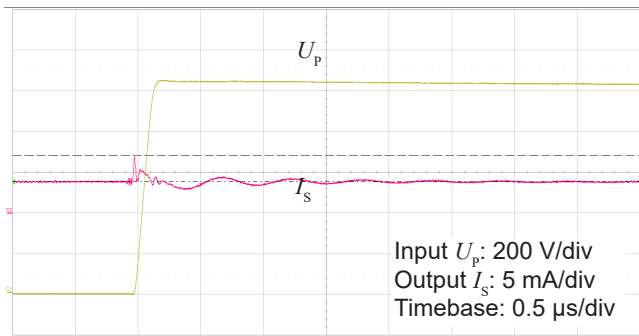

Figure 7: Detail of typical common mode perturbation (1000 V step with 6 kV/μs,  $R_M = 100 \Omega$ )

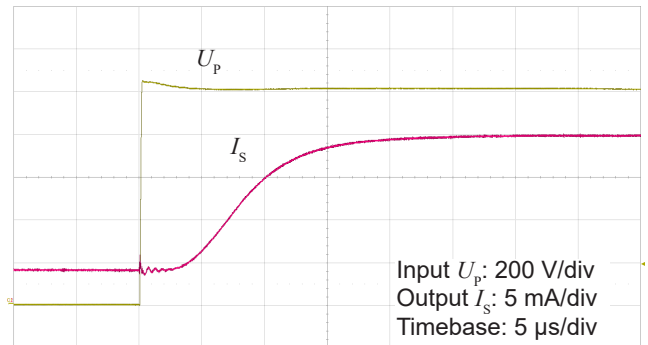

Figure 8: Typical step response (0 to 1000 V)

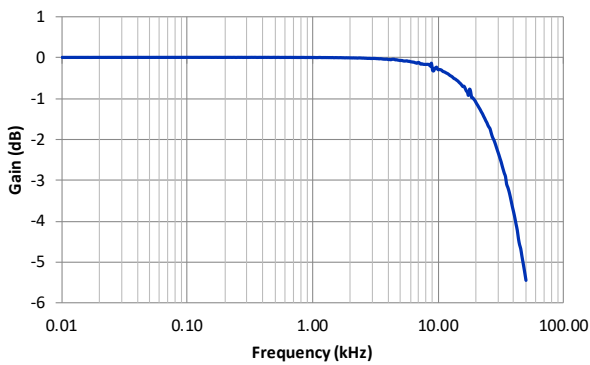

Figure 9: Gain function of frequency ( $U_p \geq 0$  V with AC signal superposed to a positive DC component)

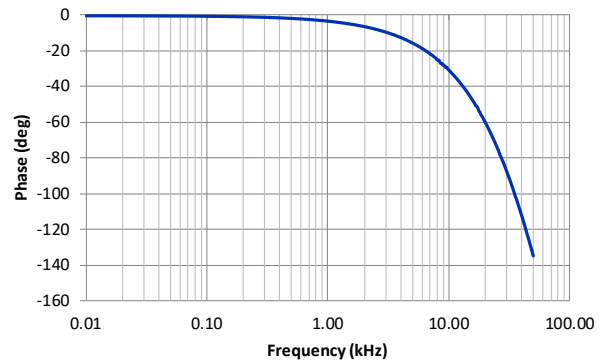

Figure 10: Phase shift function of frequency ( $U_p \geq 0$  V with AC signal superposed to a positive DC component)

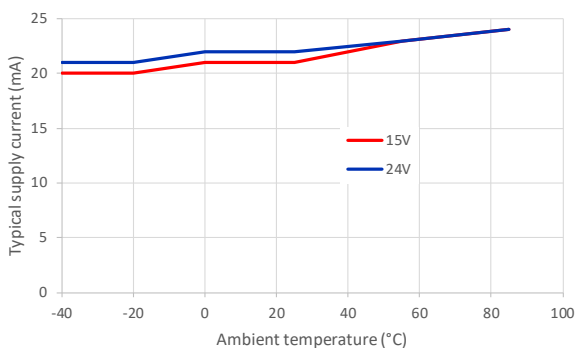

Figure 11: Supply current function of temperature

Typical performance characteristics

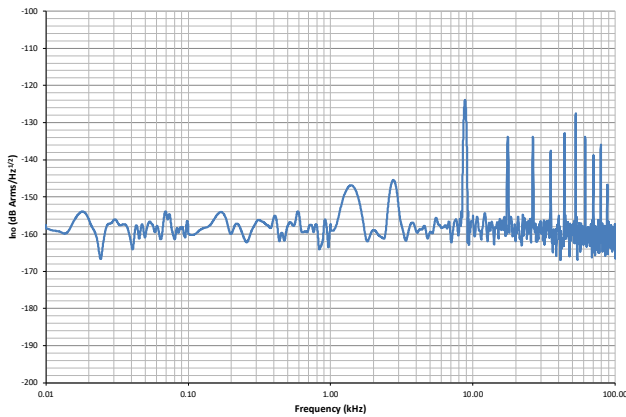

Figure 12: Typical output noise voltage spectral density  $I_{no}$  referred to secondary with  $R_M = 50 \Omega$

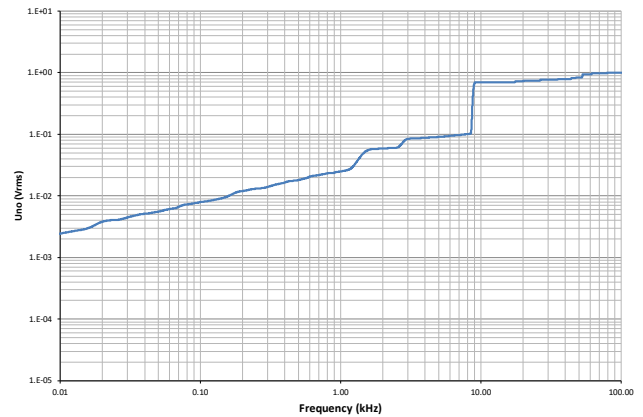

Figure 13: Typical total output RMS noise voltage  $U_{no}$  referred to primary with  $R_M = 50 \Omega$

To calculate the total output RMS noise in a frequency band  $f_1$  to  $f_2$ , the formula is:

$$U_{no}(f_1 \text{ to } f_2) = \sqrt{U_{no}(f_2)^2 - U_{no}(f_1)^2}$$

with  $U_{no}(f)$  read from figure 13 (typical, RMS value).

Example:

What is the total output RMS noise from 100 to 1 kHz?

Figure 13 gives  $U_{no}(100 \text{ Hz}) = 8 \text{ mV}$  and  $U_{no}(1 \text{ kHz}) = 25 \text{ mV}$ . Therefore, the total output RMS noise voltage referred to primary is 24 mV.

## Terms and definitions

### Simplified transducer model

The static model of the transducer with current output at temperature  $T_A$  is:

$$I_S = S \cdot U_P \cdot (1 + \varepsilon)$$

In which (referred to primary):

$$\varepsilon \cdot U_P = U_{OE} + U_{OT} + \varepsilon_S \cdot U_P + \varepsilon_{ST} \cdot U_P + \varepsilon_L(U_{Pmax}) \cdot U_{Pmax}$$

- $U_P$  : primary voltage (V)
- $U_{Pmax}$  : maximum primary voltage applied to the transducer (V)
- $I_S$  : secondary current (A)
- $S$  : sensitivity of the transducer
- $TCS$  : temperature coefficient of  $S$
- $T_A$  : ambient operating temperature (°C)
- $U_{OE}$  : electrical offset voltage (V)
- $U_{OT}$  : temperature variation of  $U_{OE}$  (V)
- $\varepsilon_S$  : sensitivity error at 25 °C
- $\varepsilon_{ST}$  : thermal drift of  $S$
- $\varepsilon_L(U_{Pmax})$  : linearity error for  $U_{Pmax}$

This model is valid for primary voltage  $U_P$  between 0 and  $+U_P$  only.

This is the absolute maximum error. As all errors are independent, a more realistic way to calculate the error would be to use the following formula:

$$\varepsilon = \sqrt{\sum_{i=1}^N \varepsilon_i^2}$$

### Total error referred to primary

The total error  $\varepsilon_{tot}$  is the error at  $\pm U_{PN}$ , relative to the rated value  $U_{PN}$ .

It includes all errors mentioned above

- the electrical offset  $U_{OE}$
- the sensitivity error  $\varepsilon_S$
- the linearity error  $\varepsilon_L$  (to  $U_{PN}$ ).

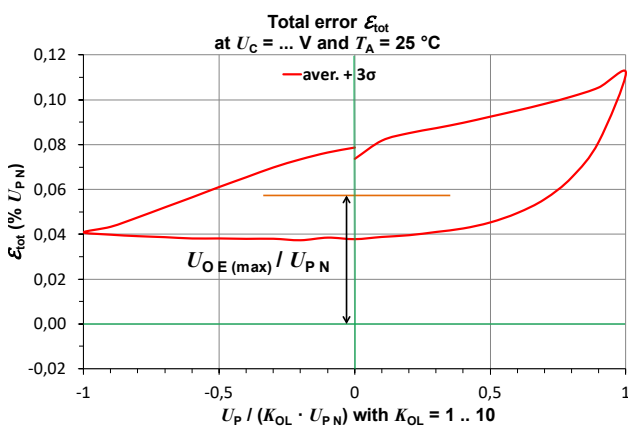
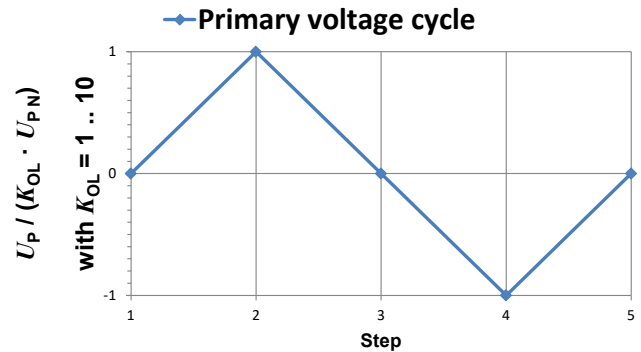

Figure 14: Total error  $\varepsilon_{tot}$

### Electrical offset referred to primary



$K_{OL}$ : Overload factor

Figure 15: voltage cycle used to measure the electrical offset (transducer supplied)

Using the voltage cycle shown in previous figure, the electrical offset voltage  $U_{OE}$  is the residual output referred to primary when the input voltage is zero.

The temperature variation  $U_{OT}$  of the electrical offset voltage

$$U_{OE} = \frac{U_{P(3)} + U_{P(5)}}{2}$$

$U_{OE}$  is the variation of the electrical offset from 25 °C to the considered temperature.

### Sensitivity and linearity

$$U_{OT}(T) = U_{OE}(T) - U_{OE}(25^\circ\text{C})$$

To measure sensitivity and linearity, the primary voltage (DC) is cycled from 0 to  $U_P$ , then to  $-U_P$  and back to 0 (equally spaced  $U_P/10$  steps). The sensitivity  $S$  is defined as the slope of the linear regression line for a cycle between  $\pm U_{PN}$ .

The linearity error  $\varepsilon_L$  is the maximum positive or negative difference between the measured points and the linear regression line, expressed in % of  $U_{PN}$ .

### Delay times

The delay time  $t_{D10}$  @ 10 % and the delay time  $t_{D90}$  @ 90 % with respect to the primary are shown in the next figure.

Both slightly depend on the primary voltage  $dv/dt$ .

They are measured at nominal voltage.

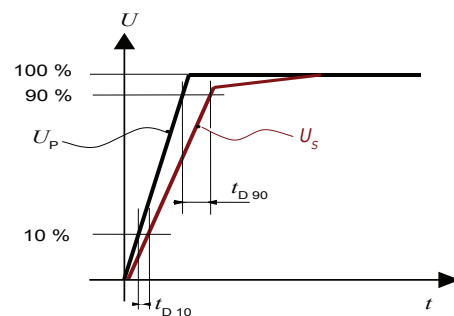
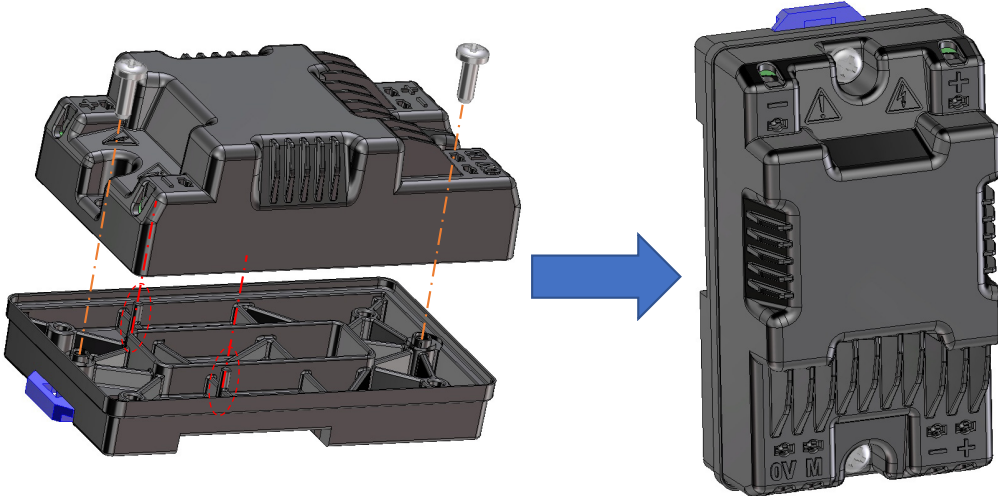

Figure 16: delay time  $t_{D10}$  @ 10 % and delay time  $t_{D90}$  @ 90 %.

### Rail DIN mounting

1. Place DVC on DIN rail adaptor support respecting the **2 Poka-Yoke** features



2. Tighten the **2 PT screws** from the adaptor kit (torque = 0.4 N.m  $\pm$ 20 %)
3. Place **DIN rail lower edge** inside DIN rail adaptor support lower notch
4. Help the blue spring lock to **move up** with a flat screwdriver
5. Then **rotate** transducer to place it on the rail

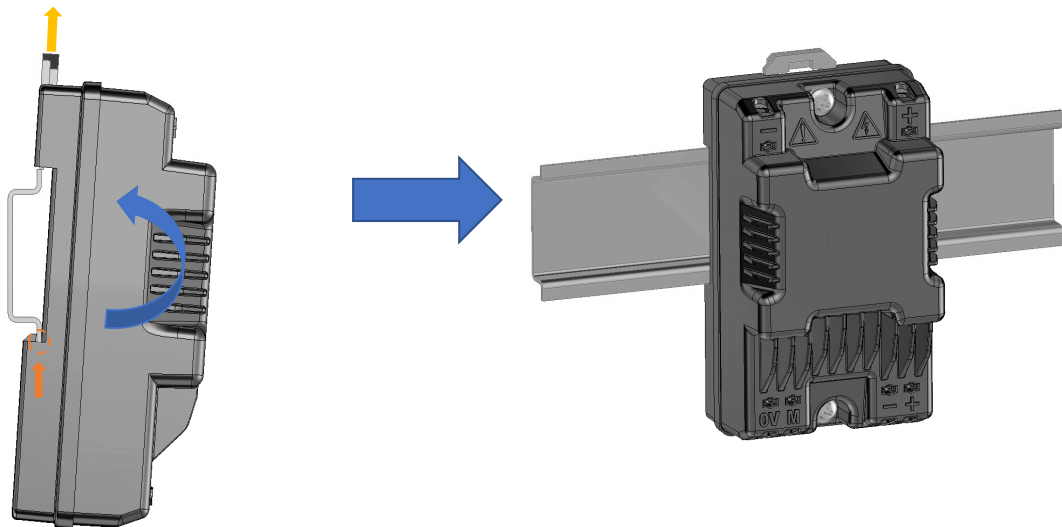

6. When placed, relax the force applied with screwdriver.
7. Manually test that transducer is well fixed

Rail DIN kit reference number 93.30.R2.000.0 to be ordered separately.

Dimensions (in mm)

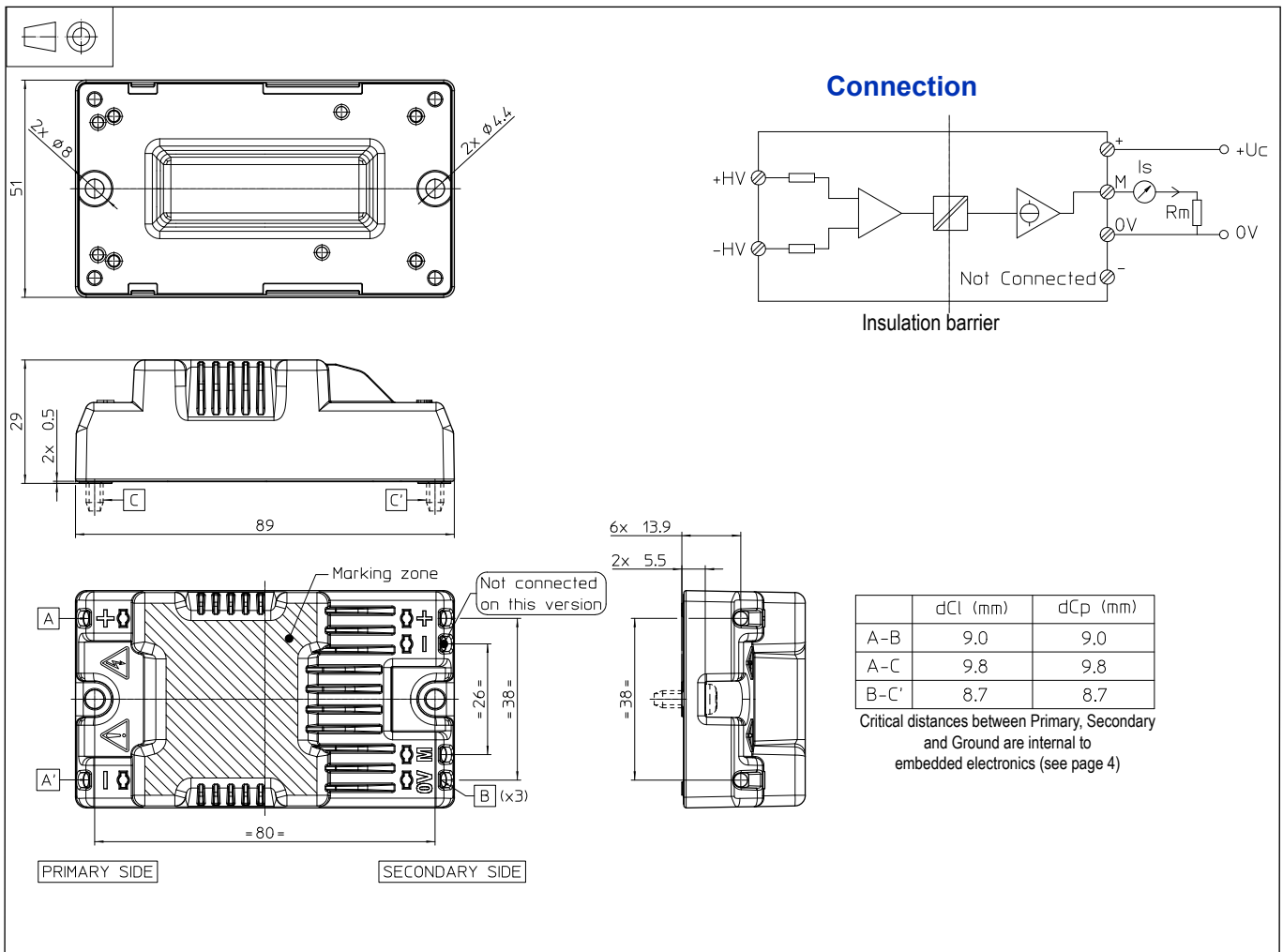

**Mechanical characteristics**

- General tolerance  $\pm 0.5$  mm
- Transducer fastening
  - 2 holes  $\varnothing 4.4$  mm
  - 2 M4 steel screws
  - Recommended fastening torque 2.1 N.m ( $\pm 10\%$ )
- Primary and secondary connections
  - WAGO 2061 connectors
  - use a flat head screwdriver with  $\varnothing 2.5$  mm (recommended)
  - 20 ... 16 AWG (solid or fine-stranded conductor) with strip length between 7 to 10 mm
  - slowly press the connector through the cover dedicated holes until the wire is locked/unlocked

**Remarks**

- $I_s$  is positive when  $U_{HV+} - U_{HV-} > 0$  V
- The primary cables have to be routed together all the way (< 30 m)
- The secondary cables also have to be routed together all the way
- Installation of the transducer must be done unless otherwise specified on the datasheet, according to LEM Transducer Generic Mounting Rules. Please refer to LEM document N°ANE120504 available on our Web site: <https://www.lem.com/en/file/3137/download/>

Note: Additional information available on request.

单击下面可查看定价，库存，交付和生命周期等信息

[>>LEM\(莱姆\)](#)