

Voltage transducer DV 4200/SP3

$V_{PN} = 4200\text{ V}$

For the electronic measurement of voltage: DC, AC, pulsed..., with galvanic separation between the primary and the secondary circuit.

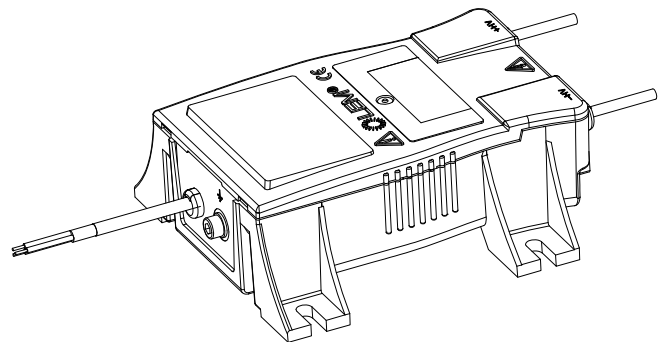

Features

- Bipolar and insulated measurement up to 6 kV
- Current output
- Primary input on cables
- Footprint compatible with OV, CV 4 and LV 200-AW/2 families.

Advantages

- Low consumption and low losses
- Compact design
- Good behavior under common mode variations
- Excellent accuracy (offset, sensitivity, linearity)
- Response time 60 μs
- Low temperature drift
- High immunity to external interferences.

Applications

- Single or three phase inverters
- Propulsion and braking choppers
- Propulsion converters
- Auxiliary converters
- High power drives
- Substations
- On-board energy meters
- Energy metering.

Standards

- EN 50155: 2017
- EN 50124-1: 2017
- EN 50121-3-2: 2016
- EN 50463 series: 2017.

Application Domain

- Railway (fixed installations and onboard).

Absolute maximum ratings

Parameter	Symbol	Value
Maximum supply voltage ($V_p = 0$ V, 0.1 s)	$\pm \hat{U}_{C \max}$	± 34 V
Maximum supply voltage (working) (-40 ... 85 °C)	$\pm U_{C \max}$	± 26.4 V
Maximum primary voltage (-40 ... 85 °C)	$V_{P \max}$	6 kV
Maximum steady state primary voltage (-40 ... 85 °C)	$V_{PN \max}$	4200 V see derating on figure 2

Absolute maximum ratings apply at 25 °C unless otherwise noted.
 Stresses above these ratings may cause permanent damage.
 Exposure to absolute maximum ratings for extended periods may degrade reliability.

Environmental and mechanical characteristics

Parameter	Symbol	Unit	Min	Typ	Max	Comment
Ambient operating temperature	T_A	°C	-40		85	
Ambient storage temperature	$T_{A \text{st}}$	°C	-50		90	
Equipment operating temperature class						EN 50155: OT6
Switch-on extended operating temperature class						EN 50155: ST0
Rapid temperature variation class						EN 50155: H2
Conformal coating type						EN 50155: PC2
Relative humidity	RH	%			95	
Shock & vibration categorie and class						EN 50155: 1B, (EN 61373)
Mass	m	g		750		
Ingress protection rating				IP54		IEC 60529 by construction (Indoor use)
Pollution degree					PD4	Insulation voltage accordingly
Altitude		m			2000 ¹⁾	

Note: ¹⁾ Insulation coordination at 2000 m.

RAMS data

Parameter	Symbol	Unit	Min	Typ	Max	Comment
Useful life class						EN 50155: L4
Mean failure rate	λ	h^{-1}		1/1883371		According to IEC 62380 $T_A = 45$ °C ON: 20 hrs/day ON/OFF: 320 cycles/year $U_C = \pm 24$ V, $U_p = 4200$ V

Insulation coordination

Parameter	Symbol	Unit	Value	Comment
RMS voltage for AC insulation test, 50 Hz, 1 min	U_d	kV	18.5	100 % tested in production
Impulse withstand voltage 1.2/50 μ s	\hat{U}_W	kV	30	
Partial discharge extinction RMS voltage @ 10 pC	U_e	V	5000	
Insulation resistance	R_{INS}	M Ω	200	Measured at 500 V DC
Clearance (pri. - sec.)	d_{Cl}	mm	see dimensions drawing on page 8	Shortest distance through air
Creepage distance (pri. - sec.)	d_{Cp}	mm		Shortest path along device body
Case material	-	-	V0	According to UL 94
Comparative tracking index	CTI		600	

Accuracy class

Parameter	Accuracy class	Comment
Class accuracy for a rated primary voltage $V_{PN} = 3000$ V	0.5 R	According to EN 50463-2
Class accuracy for a rated primary voltage $V_{PN} = 1500$ V	0.75 R	According to EN 50463-2

If used for energy measurement according to EN 50463, please note that the re-verification period of the transducer may be subject to national or international legal requirements.
Recommended re-verification period is at least 8 years.

Electrical data

At $T_A = 25\text{ °C}$, $U_C = \pm 24\text{ V}$, $R_M = 100\ \Omega$, unless otherwise noted.

Lines with a * in the conditions column apply over the $-40 \dots 85\text{ °C}$ ambient temperature range.

Parameter	Symbol	Unit	Min	Typ	Max	Conditions
Primary nominal RMS voltage	V_{PN}	V			4200	*
Primary voltage, measuring range	V_{PM}	V	-6000		6000	*
Measuring resistance	R_M	Ω	0		140	* See derating on figure 2. For $ V_{PM} < 6\text{ kV}$, max value of R_M is given on figure 1
Secondary nominal RMS current	I_{SN}	mA			50	*
Secondary current	I_S	mA	-71.4		71.4	*
Supply voltage	$\pm U_C$	V	± 13.5	± 24	± 26.4	*
Rise time of U_C (10-90 %)	t_{rise}	ms			100	
Current consumption @ $U_C = \pm 24\text{ V}$ at $V_P = 0\text{ V}$	I_C	mA		$20 + I_S$	$25 + I_S$	
Inrush current						NA (EN 50155)
Interruptions on power supply voltage class						NA (EN 50155)
Supply change-over class						NA (EN 50155)
Offset current	I_O	μA	-50	0	50	100 % tested in production
Temperature variation of I_O	I_{OT}	μA	-80 -80 -100		80 80 100	-25 ... 70 °C -25 ... 85 °C -40 ... 85 °C, 100 % tested in production
Sensitivity	G	$\mu\text{A/V}$		11.9048		50 mA for 4200 V
Sensitivity error	ε_G	%	-0.2	0	0.2	
Thermal drift of sensitivity	ε_{GT}	%	-0.5 -0.8 -0.8		0.5 0.8 0.8	-25 ... 70 °C -25 ... 85 °C -40 ... 85 °C *
Linearity error	ε_L	% of V_{PM}	-0.1		0.1	* $\pm 6000\text{ V}$ range
Overall accuracy	X_G	% of V_{PN}	-0.3 -0.7 -1 -1		0.3 0.7 1 1	25 °C; 100 % tested in production -25 ... 70 °C -25 ... 85 °C -40 ... 85 °C *
Output RMS current noise	I_{no}	μA		10		1 Hz to 100 kHz
Reaction time @ 10 % of V_{PN}	t_{ra}	μs		21		
Response time @ 90 % of V_{PN}	t_r	μs		48	60	0 to 4200 V step, 6 kV/ μs
Frequency bandwidth	BW	kHz		12 6.5 1.6		3 dB 1 dB 0.1 dB
Start-up time	t_{start}	ms		190	250	*
Resistance of primary (winding)	R_P	M Ω		23		*
Total primary power loss @ V_{PN}	P_P	W		0.77		*

Definition of typical, minimum and maximum values

Minimum and maximum values for specified limiting and safety conditions have to be understood as such as well as values shown in "typical" graphs. On the other hand, measured values are part of a statistical distribution that can be specified by an interval with upper and lower limits and a probability for measured values to lie within this interval. Unless otherwise stated (e.g. "100 % tested"), the LEM definition for such intervals designated with "min" and "max" is that the probability for values of samples to lie in this interval is 99.73 %. For a normal (Gaussian) distribution, this corresponds to an interval between -3 sigma and $+3$ sigma. If "typical" values are not obviously mean or average values, those values are defined to delimit intervals with a probability of 68.27 %, corresponding to an interval between $-\sigma$ and $+\sigma$ for a normal distribution. Typical, maximal and minimal values are determined during the initial characterization of a product.

Typical performance characteristics

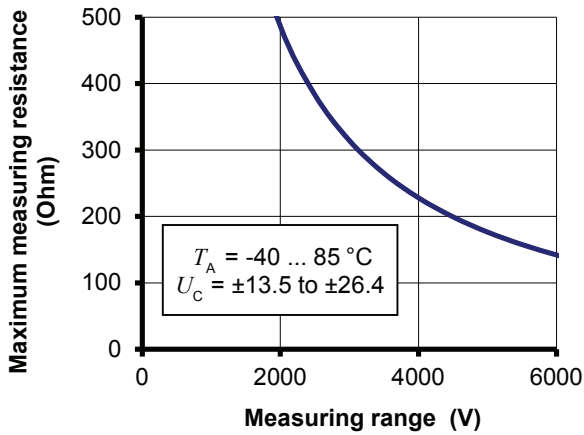

Figure 1: Maximum measuring resistance

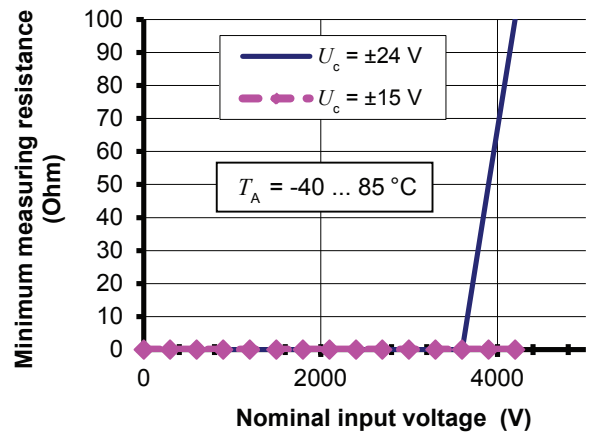

Figure 2: Minimum measuring resistance
For T_A under 80 °C, the minimum measuring resistance is 0 Ω whatever U_C

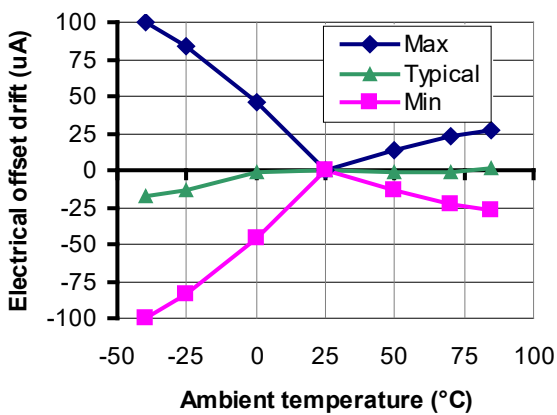

Figure 3: Electrical offset thermal drift

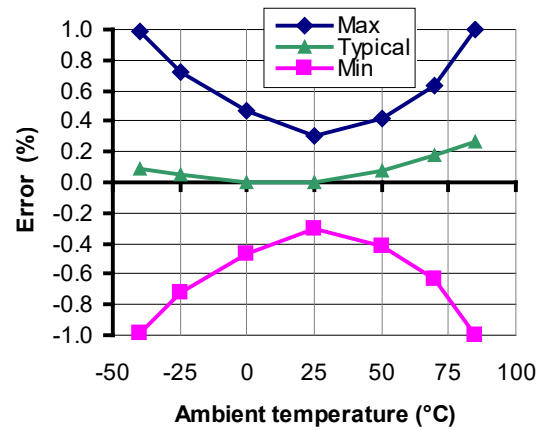

Figure 4: Overall accuracy in temperature

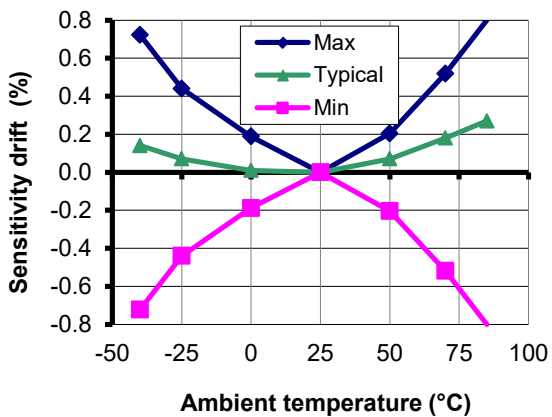

Figure 5: Sensitivity thermal drift

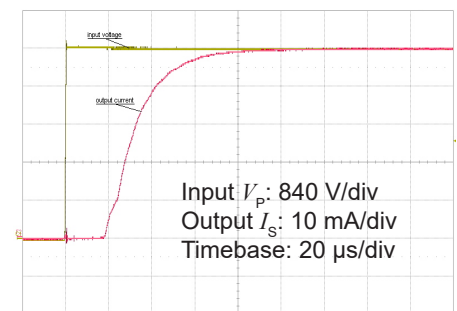

Figure 6: Typical step response (0 to 4200 V)

Typical performance characteristics

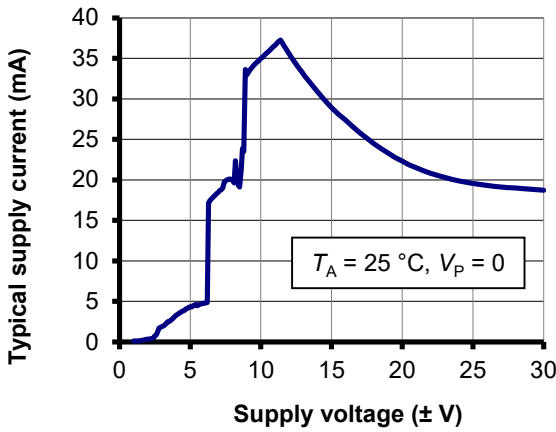

Figure 7: Supply current function of supply voltage

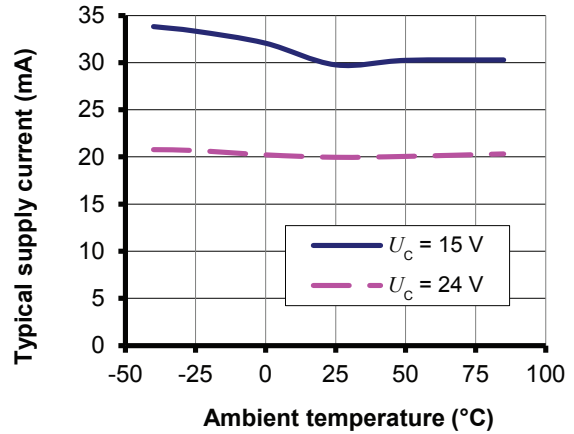

Figure 8: Supply current function of temperature

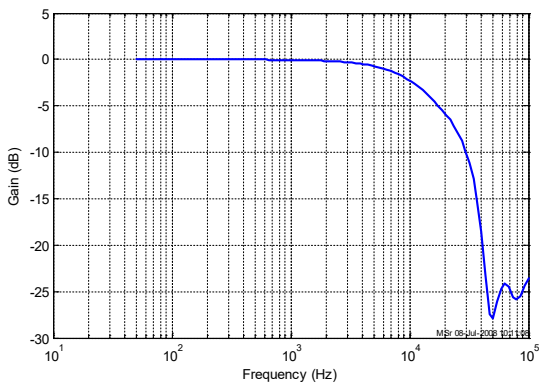

Figure 9: Typical frequency response

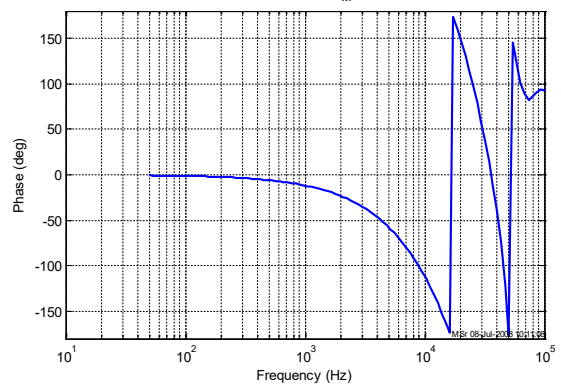
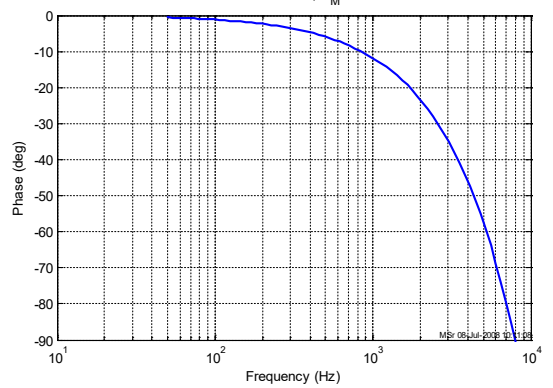
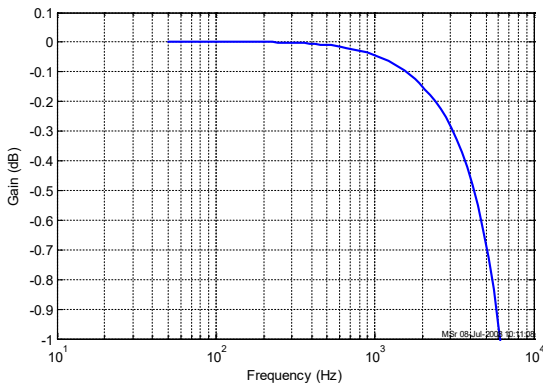

Figure 10: Typical frequency response (detail)



Typical performance characteristics continued

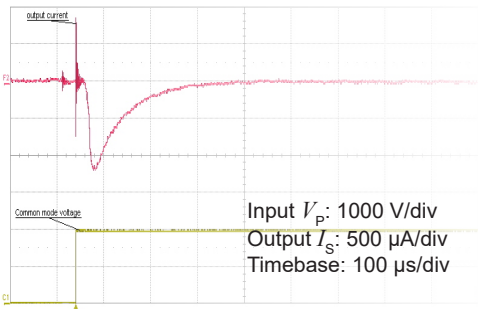

Figure 11: Typical common mode perturbation (4200 V step with 6 kV/µs $R_M = 100 \Omega$)

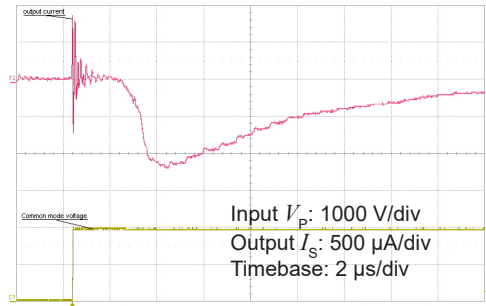

Figure 12: Detail of typical common mode perturbation (4200 V step with 6 kV/µs, $R_M = 100 \Omega$)

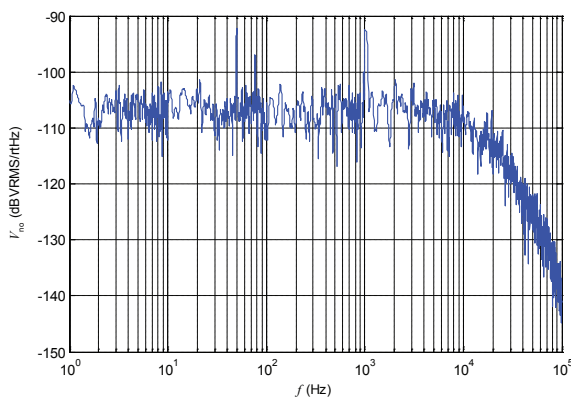

Figure 13: Typical output RMS noise voltage of V (R_M) with $R_M = 50 \Omega$

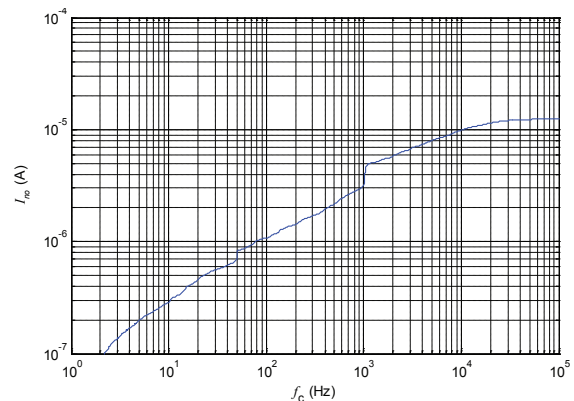

Figure 14: Typical total output RMS noise current with $R_M = 50 \Omega$ (f_c is upper cut-off frequency of band low cut off frequency is 1 Hz)

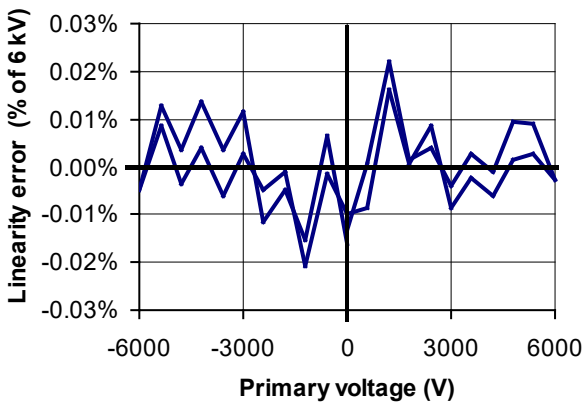

Figure 15: Typical linearity error

Figure 13 (output RMS noise voltage) shows that there are no significant discrete frequencies in the output. Figure 14 confirms the absence of steps in the total output RMS noise current that would indicate discrete frequencies.

To calculate the noise in a frequency band $f1$ to $f2$, the formula is:

$$I_{no}(f1 \text{ to } f2) = \sqrt{I_{no}(f2)^2 - I_{no}(f1)^2}$$

with $I_{no}(f)$ read from figure 14 (typical, RMS value).

Example:

What is the noise from 10 to 100 Hz?

Figure 14 gives $I_{no}(10 \text{ Hz}) = 0.32 \mu\text{A}$ and $I_{no}(100 \text{ Hz}) = 1 \mu\text{A}$. The output RMS current noise is therefore.

$$\sqrt{(1 \times 10^{-6})^2 - (0.32 \times 10^{-6})^2} = 0.95 \mu\text{A}$$

Performance parameters definition

The schematic used to measure all electrical parameters are:

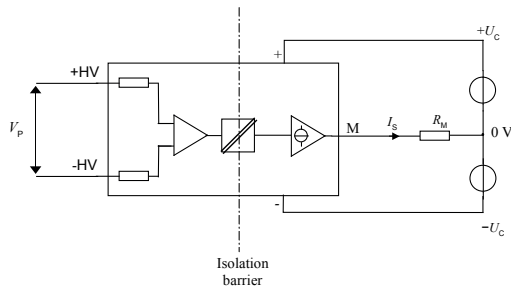

Figure 16: standard characterization schematics for current output transducers ($R_M = 50 \Omega$ unless otherwise noted)

Transducer simplified model

The static model of the transducer at temperature T_A is:

$$I_S = G \cdot V_P + \varepsilon$$

In which

$$\varepsilon = I_{OE} + I_{OT}(T_A) + \varepsilon_G \cdot G \cdot V_P + \varepsilon_{GT}(T_A) \cdot G \cdot V_P + \varepsilon_L \cdot G \cdot V_{PM}$$

- I_S : secondary current (A)
- G : sensitivity of the transducer ($\mu A/V$)
- V_P : primary voltage (V)
- V_{PM} : primary voltage, measuring range (V)
- T_A : ambient operating temperature ($^{\circ}C$)
- I_{OE} : electrical offset current (A)
- $I_{OT}(T_A)$: temperature variation of I_{OE} at temperature T_A (A)
- ε_G : sensitivity error at $25^{\circ}C$
- $\varepsilon_{GT}(T_A)$: thermal drift of sensitivity at temperature T_A
- ε_L : linearity error

This is the absolute maximum error. As all errors are independent, a more realistic way to calculate the error would be to use the following formula:

$$\varepsilon = \sqrt{\sum_{i=1}^N \varepsilon_i^2}$$

Sensitivity and linearity

To measure sensitivity and linearity, the primary voltage (DC) is cycled from 0 to V_{PM} , then to $-V_{PM}$ and back to 0 (equally spaced $V_{PM}/10$ steps).

The sensitivity G is defined as the slope of the linear regression line for a cycle between $\pm V_{PM}$.

The linearity error ε_L is the maximum positive or negative difference between the measured points and the linear regression line, expressed in % of the maximum measured value.

Electrical offset

The electrical offset current I_{OE} is the residual output current when the input voltage is zero.

The temperature variation I_{OT} of the electrical offset current I_{OE} is the variation of the electrical offset from $25^{\circ}C$ to the considered temperature.

Overall accuracy

The overall accuracy X_G is the error at $\pm V_{PN}$, relative to the rated value V_{PN} .

It includes all errors mentioned above.

Response and reaction times

The response time t_r and the reaction time t_{ra} are shown in the next figure.

Both depend on the primary voltage dv/dt . They are measured at nominal voltage.

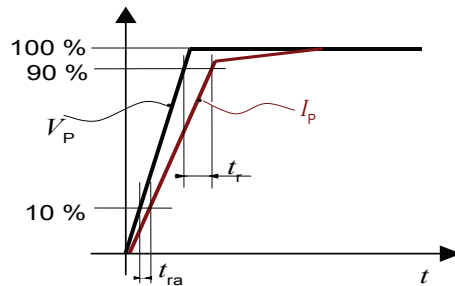
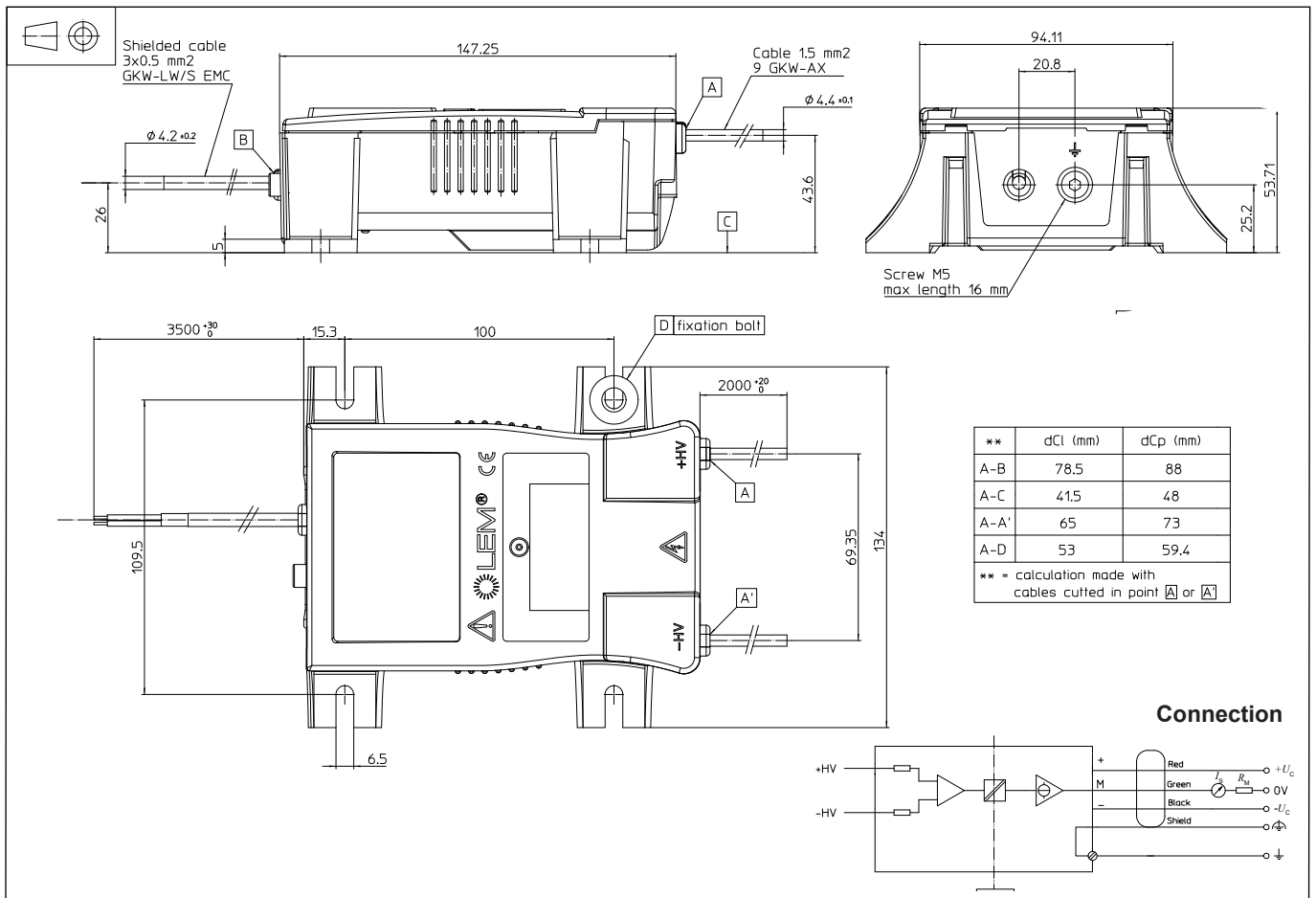

Figure 17: response time t_r and reaction time t_{ra}

Dimensions (in mm)



Mechanical characteristics

- General tolerance ±1 mm
- Transducer fastening 4 M6 steel screws
4 washers ext. Ø18 mm
Recommended fastening torque 5 N·m
- Connection of primary 2 x 1.5 mm² cables
- Connection of secondary 3 x 0.5 mm² shielded cable
- Earth connection
Recommended fastening torque 2.2 N·m

Remarks

- I_s is positive when a positive voltage is applied on +HV.
- The transducer is directly connected to the primary voltage.
- The primary cables have to be routed together all the way.
- The secondary cables also have to be routed together all the way.
- Installation of the transducer is to be done without primary or secondary voltage present
- Installation of the transducer must be done unless otherwise specified on the datasheet, according to LEM Transducer Generic Mounting Rules. Please refer to LEM document N°ANE120504 available on our Web site: [Products/Product Documentation](#).

Note: Additional information available on request.

Safety

This transducer must be used in limited-energy secondary circuits according to IEC 61010-1.



This transducer must be used in electric/electronic equipment with respect to applicable standards and safety requirements in accordance with the manufacturer's operating instructions.



Caution, risk of electrical shock

When operating the transducer, certain parts of the module can carry hazardous voltage (e.g. primary connections, power supply). Ignoring this warning can lead to injury and/or cause serious damage. This transducer is a build-in device, whose conducting parts must be inaccessible after installation. A protective housing or additional shield could be used. Main supply must be able to be disconnected.

单击下面可查看定价，库存，交付和生命周期等信息

[>>LEM\(莱姆\)](#)