

Voltage Transducer DVM series

$$U_{PN} = 1800 \dots 4200 \text{ V}$$

Ref: DVM 1800; DVM 2000; DVM 3000; DVM 3500; DVM 3600; DVM 4000; DVM 4200

For the electronic measurement of voltage: DC, AC, pulsed..., with galvanic separation between the primary and the secondary circuit.



Features

- Bipolar and insulated measurement of voltage
- Current output
- Primary input and output connections with M5 studs
- Compatible with LV 100 family
- Built-in device.

Advantages

- Low consumption and low losses
- Compact design
- Very low sensitivity to common mode voltage variations
- Excellent accuracy (offset, sensitivity, linearity)
- Fast delay time
- Low temperature drift
- High immunity to external interferences.

Applications

- AC variable speed and servo motor drives
- Static converters for DC motor drives
- Battery supplied applications
- Uninterruptible Power Supplies (UPS)
- Switched Mode Power Supplies (SMPS)
- Power supplies for welding applications
- Renewable Energy (Solar and Wind)
- Single or three phase inverters

- Propulsion and braking choppers
- Propulsion converters
- Auxiliary converters
- High power drives
- Substations.

Standards

- EN 50155: 2021
- EN 50121-3-2: 2016
- EN 50124-1: 2017
- IEC 62497-1: 2010
- IEC 61010-1: 2010
- IEC 62477-1: 2012
- UL 347 ¹⁾: 2016

Application Domains

- Industrial
- Railway (fixed installations and onboard).

Note: ¹⁾ When used with UL 347 Isolator N° 92.24.06.420.0..

Safety



Caution

If the device is used in a way that is not specified by the manufacturer, the protection provided by the device may be compromised. Always inspect the electronics unit and connecting cable before using this product and do not use it if damaged. Mounting assembly shall guarantee the maximum primary conductor temperature, fulfill clearance and creepage distance, minimize electric and magnetic coupling, and unless otherwise specified can be mounted in any orientation.



Caution, risk of electrical shock

This transducer must be used in limited-energy secondary circuits SELV according to IEC 61010-1, in electric/electronic equipment with respect to applicable standards and safety requirements in accordance with the manufacturer's operating specifications.

Use caution during installation and use of this product; certain parts of the module can carry hazardous voltages and high currents (e.g. power supply, primary conductor).

Ignoring this warning can lead to injury and or/cause serious damage.

De-energize all circuits and hazardous live parts before installing the product.

All installations, maintenance, servicing operations and use must be carried out by trained and qualified personnel practicing applicable safety precautions.

This transducer is a build-in device, whose hazardous live parts must be inaccessible after installation.

This transducer must be mounted in a suitable end-enclosure.

Besides make sure to have a distance of minimum 30 mm between the primary terminals of the transducer and other neighboring components.

Main supply must be able to be disconnected.

Never connect or disconnect the external power supply while the primary circuit is connected to live parts.

Never connect the output to any equipment with a common mode voltage to earth greater than 30 V.

This transducer is a built-in device, not intended to be cleaned with any product. Nevertheless if the user must implement cleaning or washing process, validation of the cleaning program has to be done by himself.



ESD susceptibility

The product is susceptible to be damaged from an ESD event and the personnel should be grounded when handling it.

Do not dispose of this product as unsorted municipal waste. Contact a qualified recycler for disposal.



Underwriters Laboratory Inc. recognized component

Absolute maximum ratings

Parameter	Symbol	Unit	Value
Maximum DC supply voltage = ($U_p = 0$ V, 0.1 s)	$\pm \hat{U}_{C \max}$	V	± 33.6
Maximum DC supply voltage = (working) (- 40 ... + 85 °C)	$\pm U_{C \max}$	V	± 26.4
Electrostatic discharge voltage (HBM - Human Body Model)	$U_{ESD \text{ HBM}}$	kV	4
Maximum DC common mode voltage	$U_{HV+} + U_{HV-}$ and $ U_{HV+} - U_{HV-} $	kV	≤ 6.3 $\leq U_{PM}$

Absolute maximum ratings apply at 25 °C unless otherwise noted.
Stresses above these ratings may cause permanent damage.
Exposure to absolute maximum ratings for extended periods may degrade reliability.

Environmental and mechanical characteristics

Parameter	Symbol	Unit	Min	Typ	Max	Comment
Ambient operating temperature	T_A	°C	-40		85	
Ambient storage temperature	$T_{A \text{ st}}$	°C	-50		90	
Equipment operating temperature class						EN 50155: OT6
Switch-on extended operating temperature class						EN 50155: ST0
Rapid temperature variation class						EN 50155: H1
Conformal coating type						EN 50155: PC2
Relative humidity	RH	%				Class 3K3 according to Table 1 of EN 60721-3-3
Shock & vibration categorie and class						EN 50155: 1B (EN 61373)
Mass	m	g		375		
Ingress protection rating				IP40		IEC 60529 (Indoor use)
Pollution degree					PD4	Insulation voltage accordingly
Altitude		m			2000 ¹⁾	
Impact rating				IK06		According to IEC 62262

RAMS data

Parameter	Symbol	Unit	Min	Typ	Max	Comment
Useful life class						EN 50155: L4
Mean failure rate	$\bar{\lambda}$	h^{-1}		1/1827550		According to IEC 62380 $T_A = 45$ °C ON: 20 hrs/day ON/OFF: 320 cycles/year $U_C = \pm 24$ V , $U_P = 4200$ V

Note: ¹⁾ Insulation coordination at 2000 m.

UL 347: Ratings and assumptions of certification

File # E315896 Volume: 1 Section: 3

Standards

- CSA C22.2 No. 253 Medium-Voltage AC Contactors, Controllers, and Control Centers
- UL 347 Standards for Safety for Medium-Voltage AC Contactors, Controllers, and Control Centers.

Conditions of acceptability

When installed in the end-use equipment, consideration shall be given to the following:

- 1 - *These devices must be mounted in a suitable end-use enclosure.*
- 2 - *The terminals have not been evaluated for field wiring.*
- 3 - *The rated Basic Insulation Level (BIL) is 20 kV for this device, after performing Impulse Withstand Tests. Additional testing will be required if a higher BIL rating is desired.*
- 4 - *For products rated more than 2500 V, the specific kit model "UL 347 isolator" shall be mounted to the DVM.*
- 5 - *The products have been evaluated for a maximum surrounding air temperature of 85 °C..*
- 6 - *Low voltage circuits are intended to be powered by a circuit derived from an isolating source (such as a transformer, optical isolator, limiting impedance or electro-mechanical relay) and having no direct connection back to the primary circuit (other than through the grounding means).*

Marking

Only those products bearing the UL or UR Mark should be considered to be Listed or Recognized and covered under UL's Follow-Up Service. Always look for the Mark on the product.

Assembly of UL 347 Isolator on primary studs.

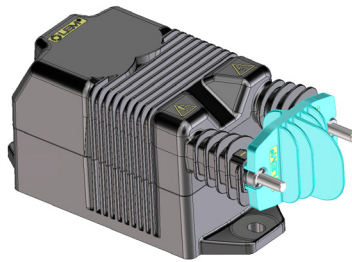

UL 347 Isolator, reference number 92.24.06.420.0 provided.

Insulation coordination

Parameter	Symbol	Unit	≤ Value	Comment
RMS voltage for AC insulation test, 50 Hz, 1 min	U_d	kV	12	
Impulse withstand voltage 1.2/50 μ s	U_{Ni}	kV	30	According to IEC 62497-1
Partial discharge RMS test voltage ($q_m < 10$ pC)	U_t	V	5000	
Case material	-	-	V0	
Comparative tracking index	CTI		600	According to UL 94

Between primary and secondary

Clearance	d_{Cl}	mm	74	Shortest distance through air
Creepage distance	d_{Cp}	mm	101	Shortest path along device body
Application example RMS voltage line-to-neutral		V	1000	Reinforced insulation according to IEC 60664-1, IEC 61010-1 or IEC 62477-1 CAT III, PD2
Application example System voltage RMS		V	3600	Basic insulation according to IEC 61800-5-1 CAT III, PD2
Application example Rated insulation RMS voltage	U_{Nm}	V	4800	Basic insulation according to IEC 62497-1 CAT III, PD2, Rolling stock
Application example Rated insulation RMS voltage	U_{Nm}	V	3700	Reinforced insulation according to IEC 62479-1 CAT II, PD2

Between primary and ground (fastening screw M6 head)

Clearance	d_{Cl}	mm	45	Shortest distance through air
Creepage distance	d_{Cp}	mm	101	Shortest path along device body
Application example Rated insulation RMS voltage		V	1000	Reinforced insulation according to IEC 61010-1 CAT III, PD2

Between secondary and ground (fastening screw M6 head)

Clearance	d_{Cl}	mm	16	Shortest distance through air
Creepage distance	d_{Cp}	mm	29	Shortest path along device body
Application example Rated insulation RMS voltage		V	1000	Basic insulation according to IEC 61010-1 CAT III, PD2

Electrical data DVM 1800

 At $T_A = T_{A\min} \dots T_{A\max}$, $\pm U_C = \pm 24$ V, $R_M = 100$ Ω , unless otherwise noted (see Min, Max, typ, definition paragraph in [page 13](#)).

Parameter	Symbol	Unit	Min	Typ	Max	Comment
Primary nominal DC voltage (continuous)	U_{PNDC}	V		1800		
Primary nominal AC RMS voltage (continuous)	U_{PNAC}	V		1800		
Primary voltage, measuring range	U_{PM}	V	-2700		2700	
Measuring resistance	R_M	Ω	0			see derating on figure 1
Secondary current	I_S	mA		50		@ U_{PNDC}
DC supply voltage =	U_C	V	± 10.8	$\pm 12 \dots \pm 24$	± 26.4	Tolerance ± 10 % on Typ value
DC current consumption =	I_C	mA		30		@ $U_C = \pm 24$ V at $U_p = 0$ V
				40		@ $U_C = \pm 15$ V at $U_p = 0$ V
Power consumption $U_p = 0$ V @ U_C	P_C	W		1.44		@ $U_C = \pm 24$ V
Power consumption $U_p = U_{PNDC}$ @ U_C	P_C	W		2.64		@ $U_C = \pm 24$ V
Inrush current						NA (EN 50155)
Interruptions on power supply voltage class						NA (EN 50155)
Supply change-over class						NA (EN 50155)
Rise time of U_C (10 % ... 90 %)	t_{rise}	ms			100	
Total error	ϵ_{tot}	%	-1		1	
Total error	ϵ_{tot}	%	-0.5		0.5	@ 25 °C 100 % tested in production
Temperature variation of U_{OE} referred to primary	U_{OET}	V	-4.32		4.32	
			-3.6		3.6	@ 25 °C ... 85 °C
Electrical Offset voltage referred to primary	U_{OE}	V	-1.8		1.8	@ 25 °C 100 % tested in production
Sensitivity	S	$\mu A/V$		27.8		@ 25 °C
Sensitivity error	ϵ_S	%	-0.3		0.3	@ 25 °C
Temperature variation of sensitivity error	ϵ_{ST}	%	-0.5		0.5	referred to 25 °C
Linearity error	ϵ_L	% of U_{PN}	-0.5		0.5	@ 25 °C ± 2700 V range
RMS noise current 100 Hz ... 100 kHz referred to secondary	I_{no}	μA		30		@ 25 °C
Delay time @ 10 % of the final output value for U_{PN} step	t_{D10}	μs		30		
Delay time @ 90 % of the final output value for U_{PN} step	t_{D90}	μs		50	60	0 to 1800 V step, 6 kV/ μs
Frequency bandwidth	BW	kHz		12.8		-3 dB
				8		-1 dB
Start-up time	t_{start}	ms		190	250	
Resistance of primary	R_p	M Ω		25.1		
Total primary power loss @ U_{PN}	P_p	W		0.13		

Electrical data DVM 2000

 At $T_A = T_{Amin} \dots T_{Amax}$, $\pm U_C = \pm 24$ V, $R_M = 100 \Omega$, unless otherwise noted (see Min, Max, typ, definition paragraph in [page 13](#)).

Parameter	Symbol	Unit	Min	Typ	Max	Comment
Primary nominal DC voltage (continuous)	U_{PNDC}	V		2000		
Primary nominal AC RMS voltage (continuous)	U_{PNAC}	V		2000		
Primary voltage, measuring range	U_{PM}	V	-3000		3000	
Measuring resistance	R_M	Ω	0			see derating on figure 1
Secondary current	I_S	mA		50		@ U_{PNDC}
DC supply voltage =	U_C	V	± 10.8	$\pm 12 \dots \pm 24$	± 26.4	Tolerance ± 10 % on Typ value
DC current consumption =	I_C	mA		30		@ $U_C = \pm 24$ V at $U_p = 0$ V
				40		@ $U_C = \pm 15$ V at $U_p = 0$ V
Power consumption $U_p = 0$ V @ U_C	P_C	W		1.44		@ $U_C = \pm 24$ V
Power consumption $U_p = U_{PNDC}$ @ U_C	P_C	W		2.64		@ $U_C = \pm 24$ V
Inrush current						NA (EN 50155)
Interruptions on power supply voltage class						NA (EN 50155)
Supply change-over class						NA (EN 50155)
Rise time of U_C (10 % ... 90 %)	t_{rise}	ms			100	
Total error	ϵ_{tot}	%	-1		1	
Total error	ϵ_{tot}	%	-0.5		0.5	@ 25 °C 100 % tested in production
				-4.8		4.8
Temperature variation of U_{OE} referred to primary	U_{OET}	V	-4.0		4.0	@ 25 °C ... 85 °C
Electrical Offset voltage referred to primary	U_{OE}	V	-2.0		2.0	@ 25 °C 100 % tested in production
Sensitivity	S	$\mu A/V$		25		@ 25 °C
Sensitivity error	ϵ_S	%	-0.3		0.3	@ 25 °C
Temperature variation of sensitivity error	ϵ_{ST}	%	-0.5		0.5	referred to 25 °C
Linearity error	ϵ_L	% of U_{PN}	-0.5		0.5	@ 25 °C ± 3000 V range
RMS noise current 100 Hz ... 100 kHz referred to secondary	I_{no}	μA		30		@ 25 °C
Delay time @ 10 % of the final output value for U_{PN} step	t_{D10}	μs		30		
Delay time @ 90 % of the final output value for U_{PN} step	t_{D90}	μs		50	60	0 to 2000 V step, 6 kV/ μs
Frequency bandwidth	BW	kHz		12.8		-3 dB
				8		-1 dB
Start-up time	t_{start}	ms		190	250	
Resistance of primary	R_p	M Ω		25.1		
Total primary power loss @ U_{PN}	P_p	W		0.16		

Electrical data DVM 3000

 At $T_A = T_{A\min} \dots T_{A\max}$, $\pm U_C = \pm 24$ V, $R_M = 100$ Ω , unless otherwise noted (see Min, Max, typ, definition paragraph in [page 13](#)).

Parameter	Symbol	Unit	Min	Typ	Max	Comment
Primary nominal DC voltage (continuous)	U_{PNDC}	V		3000		
Primary nominal AC RMS voltage (continuous)	U_{PNAC}	V		3000		
Primary voltage, measuring range	U_{PM}	V	-4500		4500	
Measuring resistance	R_M	Ω	0			see derating on figure 1
Secondary current	I_S	mA		50		@ U_{PNDC}
DC supply voltage =	U_C	V	± 10.8	$\pm 12 \dots \pm 24$	± 26.4	Tolerance ± 10 % on Typ value
DC current consumption =	I_C	mA		30		@ $U_C = \pm 24$ V at $U_p = 0$ V
				40		@ $U_C = \pm 15$ V at $U_p = 0$ V
Power consumption $U_p = 0$ V @ U_C	P_C	W		1.44		@ $U_C = \pm 24$ V
Power consumption $U_p = U_{PNDC}$ @ U_C	P_C	W		2.64		@ $U_C = \pm 24$ V
Inrush current						NA (EN 50155)
Interruptions on power supply voltage class						NA (EN 50155)
Supply change-over class						NA (EN 50155)
Rise time of U_C (10 % ... 90 %)	t_{rise}	ms			100	
Total error	ϵ_{tot}	%	-1		1	
Total error	ϵ_{tot}	%	-0.5		0.5	@ 25 °C 100 % tested in production
				-7.2		7.2
Temperature variation of U_{OE} referred to primary	U_{OET}	V				@ 25 °C ... 85 °C
				-6.0		6.0
Electrical Offset voltage referred to primary	U_{OE}	V	-3.0		3.0	@ 25 °C 100 % tested in production
Sensitivity	S	$\mu A/V$		16,67		@ 25 °C
Sensitivity error	ϵ_S	%	-0.3		0.3	@ 25 °C
Temperature variation of sensitivity error	ϵ_{ST}	%	-0.5		0.5	referred to 25 °C
Linearity error	ϵ_L	% of U_{PN}	-0.5		0.5	@ 25 °C ± 4500 V range
RMS noise current 100 Hz ... 100 kHz referred to secondary	I_{no}	μA		30		@ 25 °C
Delay time @ 10 % of the final output value for U_{PN} step	t_{D10}	μs		30		
Delay time @ 90 % of the final output value for U_{PN} step	t_{D90}	μs		50	60	0 to 3000 V step, 6 kV/ μs
Frequency bandwidth	BW	kHz		12.8		-3 dB
				8		-1 dB
Start-up time	t_{start}	ms		190	250	
Resistance of primary	R_P	M Ω		25.1		
Total primary power loss @ U_{PN}	P_P	W		0.36		

Electrical data DVM 3500

At $T_A = T_{A\min} \dots T_{A\max}$, $\pm U_C = \pm 24$ V, $R_M = 100 \Omega$, unless otherwise noted (see Min, Max, typ, definition paragraph in [page 13](#)).

Parameter	Symbol	Unit	Min	Typ	Max	Comment
Primary nominal DC voltage (continuous)	U_{PNDC}	V		3500		
Primary nominal AC RMS voltage (continuous)	U_{PNAC}	V		3500		
Primary voltage, measuring range	U_{PM}	V	-5250		5250	
Measuring resistance	R_M	Ω	0			see derating on figure 1
Secondary current	I_S	mA		50		@ U_{PNDC}
DC supply voltage =	U_C	V	± 10.8	$\pm 12 \dots \pm 24$	± 26.4	Tolerance ± 10 % on Typ value
DC current consumption =	I_C	mA		30		@ $U_C = \pm 24$ V at $U_p = 0$ V
				40		@ $U_C = \pm 15$ V at $U_p = 0$ V
Power consumption $U_p = 0$ V @ U_C	P_C	W		1.44		@ $U_C = \pm 24$ V
Power consumption $U_p = U_{PNDC}$ @ U_C	P_C	W		2.64		@ $U_C = \pm 24$ V
Inrush current						NA (EN 50155)
Interruptions on power supply voltage class						NA (EN 50155)
Supply change-over class						NA (EN 50155)
Rise time of U_C (10 % ... 90 %)	t_{rise}	ms			100	
Total error	ϵ_{tot}	%	-1		1	
Total error	ϵ_{tot}	%	-0.5		0.5	@ 25 °C 100 % tested in production
				-8.4		8.4
Temperature variation of U_{OE} referred to primary	U_{OET}	V	-7.0		7.0	@ 25 °C ... 85 °C
Electrical Offset voltage referred to primary	U_{OE}	V	-3.5		3.5	@ 25 °C 100 % tested in production
Sensitivity	S	$\mu A/V$		14.29		@ 25 °C
Sensitivity error	ϵ_S	%	-0.3		0.3	@ 25 °C
Temperature variation of sensitivity error	ϵ_{ST}	%	-0.5		0.5	referred to 25 °C
Linearity error	ϵ_L	% of U_{PN}	-0.5		0.5	@ 25 °C ± 5250 V range
RMS noise current 100 Hz ... 100 kHz referred to secondary	I_{no}	μA		30		@ 25 °C
Delay time @ 10 % of the final output value for U_{PN} step	t_{D10}	μs		30		
Delay time @ 90 % of the final output value for U_{PN} step	t_{D90}	μs		50	60	0 to 3500 V step, 6 kV/ μs
Frequency bandwidth	BW	kHz		12.8		-3 dB
				8		-1 dB
Start-up time	t_{start}	ms		190	250	
Resistance of primary	R_p	M Ω		25.1		
Total primary power loss @ U_{PN}	P_p	W		0.49		

Electrical data DVM 3600

 At $T_A = T_{A\min} \dots T_{A\max}$, $\pm U_C = \pm 24$ V, $R_M = 100$ Ω , unless otherwise noted (see Min, Max, typ, definition paragraph in [page 13](#)).

Parameter	Symbol	Unit	Min	Typ	Max	Comment
Primary nominal DC voltage (continuous)	U_{PNDC}	V		3600		
Primary nominal AC RMS voltage (continuous)	U_{PNAC}	V		3600		
Primary voltage, measuring range	U_{PM}	V	-5400		5400	
Measuring resistance	R_M	Ω	0			see derating on figure 1
Secondary current	I_S	mA		50		@ U_{PNDC}
DC supply voltage =	U_C	V	± 10.8	$\pm 12 \dots \pm 24$	± 26.4	Tolerance ± 10 % on Typ value
DC current consumption =	I_C	mA		30		@ $U_C = \pm 24$ V at $U_p = 0$ V
				40		@ $U_C = \pm 15$ V at $U_p = 0$ V
Power consumption $U_p = 0$ V @ U_C	p_C	W		1.44		@ $U_C = \pm 24$ V
Power consumption $U_p = U_{PNDC}$ @ U_C	P_C	W		2.64		@ $U_C = \pm 24$ V
Inrush current						NA (EN 50155)
Interruptions on power supply voltage class						NA (EN 50155)
Supply change-over class						NA (EN 50155)
Rise time of U_C (10 % ... 90 %)	t_{rise}	ms			100	
Total error	ε_{tot}	%	-1		1	
Total error	ε_{tot}	%	-0.5		0.5	@ 25 °C 100 % tested in production
				-8.66		8.66
Temperature variation of U_{OE} referred to primary	U_{OET}	V	-7.2		7.2	@ 25 °C ... 85 °C
Electrical Offset voltage referred to primary	U_{OE}	V	-3.60		3.60	@ 25 °C 100 % tested in production
Sensitivity	S	$\mu A/V$		13.89		@ 25 °C
Sensitivity error	ε_S	%	-0.3		0.3	@ 25 °C
Temperature variation of sensitivity error	ε_{ST}	%	-0.5		0.5	referred to 25 °C
Linearity error	ε_L	% of U_{PN}	-0.5		0.5	@ 25 °C ± 5400 V range
RMS noise current 100 Hz ... 100 kHz referred to secondary	I_{no}	μA		30		@ 25 °C
Delay time @ 10 % of the final output value for U_{PN} step	t_{D10}	μs		30		
Delay time @ 90 % of the final output value for U_{PN} step	t_{D90}	μs		50	60	0 to 3600 V step, 6 kV/ μs
Frequency bandwidth	BW	kHz		12.8		-3 dB
				8		-1 dB
Start-up time	t_{start}	ms		190	250	
Resistance of primary	R_p	M Ω		25.1		
Total primary power loss @ U_{PN}	P_p	W		0.52		

Electrical data DVM 4000

 At $T_A = T_{A\min} \dots T_{A\max}$, $\pm U_C = \pm 24 \text{ V}$, $R_M = 100 \Omega$, unless otherwise noted (see Min, Max, typ, definition paragraph in [page 13](#)).

Parameter	Symbol	Unit	Min	Typ	Max	Comment
Primary nominal DC voltage (continuous)	U_{PNDC}	V		4000		
Primary nominal AC RMS voltage (continuous)	U_{PNAC}	V		4000		
Primary voltage, measuring range	U_{PM}	V	-6000		6000	
Measuring resistance	R_M	Ω	0			see derating on figure 1
Secondary current	I_S	mA		50		@ U_{PNDC}
DC supply voltage =	U_C	V	± 10.8	$\pm 12 \dots \pm 24$	± 26.4	Tolerance $\pm 10 \%$ on Typ value
DC current consumption =	I_C	mA		30		@ $U_C = \pm 24 \text{ V}$ at $U_p = 0 \text{ V}$
				40		@ $U_C = \pm 15 \text{ V}$ at $U_p = 0 \text{ V}$
Power consumption $U_p = 0 \text{ V}$ @ U_C	P_C	W		1.44		@ $U_C = \pm 24 \text{ V}$
Power consumption $U_p = U_{PNDC}$ @ U_C	P_C	W		2.64		@ $U_C = \pm 24 \text{ V}$
Inrush current						NA (EN 50155)
Interruptions on power supply voltage class						NA (EN 50155)
Supply change-over class						NA (EN 50155)
Rise time of U_C (10 % ... 90 %)	t_{rise}	ms			100	
Total error	ϵ_{tot}	%	-1		1	
Total error	ϵ_{tot}	%	-0.5		0.5	@ 25 °C 100 % tested in production
				-9.6		9.6
Temperature variation of U_{OE} referred to primary	U_{OET}	V	-8.0		8.0	@ 25 °C ... 85 °C
Electrical Offset voltage referred to primary	U_{OE}	V	-4.0		4.0	@ 25 °C 100 % tested in production
Sensitivity	S	$\mu\text{A/V}$		12.5		@ 25 °C
Sensitivity error	ϵ_S	%	-0.3		0.3	@ 25 °C
Temperature variation of sensitivity error	ϵ_{ST}	%	-0.5		0.5	referred to 25 °C
Linearity error	ϵ_L	% of U_{PN}	-0.5		0.5	@ 25 °C $\pm 6000 \text{ V}$ range
RMS noise current 100 Hz ... 100 kHz referred to secondary	I_{no}	μA		30		@ 25 °C
Delay time @ 10 % of the final output value for U_{PN} step	t_{D10}	μs		30		
Delay time @ 90 % of the final output value for U_{PN} step	t_{D90}	μs		50	60	0 to 4000 V step, 6 kV/ μs
Frequency bandwidth	BW	kHz		12.8		-3 dB
				8		-1 dB
Start-up time	t_{start}	ms		190	250	
Resistance of primary	R_p	M Ω		25.1		
Total primary power loss @ U_{PN}	P_p	W		0.64		

Electrical data DVM 4200

 At $T_A = T_{A\min} \dots T_{A\max}$, $\pm U_C = \pm 24$ V, $R_M = 100$ Ω , unless otherwise noted (see Min, Max, typ, definition paragraph in [page 13](#)).

Parameter	Symbol	Unit	Min	Typ	Max	Comment
Primary nominal DC voltage (continuous)	U_{PNDC}	V		4200		
Primary nominal AC RMS voltage (continuous)	U_{PNAC}	V		4200		
Primary voltage, measuring range	U_{PM}	V	-6000		6000	
Measuring resistance	R_M	Ω	0			see derating on figure 1
Secondary current	I_S	mA		50		@ U_{PNDC}
DC supply voltage =	U_C	V	± 10.8	$\pm 12 \dots \pm 24$	± 26.4	Tolerance ± 10 % on Typ value
DC current consumption =	I_C	mA		30		@ $U_C = \pm 24$ V at $U_p = 0$ V
				40		@ $U_C = \pm 15$ V at $U_p = 0$ V
Power consumption $U_p = 0$ V @ U_C	P_C	W		1.44		@ $U_C = \pm 24$ V
Power consumption $U_p = U_{PNDC}$ @ U_C	P_C	W		2.64		@ $U_C = \pm 24$ V
Inrush current						NA (EN 50155)
Interruptions on power supply voltage class						NA (EN 50155)
Supply change-over class						NA (EN 50155)
Rise time of U_C (10 % ... 90 %)	t_{rise}	ms			100	
Total error	ϵ_{tot}	%	-1		1	
Total error	ϵ_{tot}	%	-0.5		0.5	@ 25 °C 100 % tested in production
				-10.1		10.1
Temperature variation of U_{OE} referred to primary	U_{OET}	V	-8.4		8.4	@ 25 °C ... 85 °C
Electrical Offset voltage referred to primary	U_{OE}	V	-4.2		4.2	@ 25 °C 100 % tested in production
Sensitivity	S	$\mu A/V$		11.9		@ 25 °C
Sensitivity error	ϵ_S	%	-0.3		0.3	@ 25 °C
Temperature variation of sensitivity error	ϵ_{ST}	%	-0.5		0.5	referred to 25 °C
Linearity error	ϵ_L	% of U_{PN}	-0.5		0.5	@ 25 °C ± 6000 V range
RMS noise current 100 Hz ... 100 kHz referred to secondary	I_{no}	μA		30		@ 25 °C
Delay time @ 10 % of the final output value for U_{PN} step	t_{D10}	μs		30		
Delay time @ 90 % of the final output value for U_{PN} step	t_{D90}	μs		50	60	0 to 4200 V step, 6 kV/ μs
Frequency bandwidth	BW	kHz		12.8		-3 dB
				8		-1 dB
Start-up time	t_{start}	ms		190	250	
Resistance of primary	R_p	M Ω		25.1		
Total primary power loss @ U_{PN}	P_p	W		0.7		

Definition of typical, minimum and maximum values

Minimum and maximum values for specified limiting and safety conditions have to be understood as such as well as values shown in “typical” graphs.

On the other hand, measured values are part of a statistical distribution that can be specified by an interval with upper and lower limits and a probability for measured values to lie within this interval.

Unless otherwise stated (e.g. “100 % tested”), the LEM definition for such intervals designated with “min” and “max” is that the probability for values of samples to lie in this interval is 99.73 %.

For a normal (Gaussian) distribution, this corresponds to an interval between -3 sigma and $+3$ sigma. If “typical” values are not obviously mean or average values, those values are defined to delimit intervals with a probability of 68.27 %, corresponding to an interval between $-\text{sigma}$ and $+\text{sigma}$ for a normal distribution.

Typical, maximal and minimal values are determined during the initial characterization of the product.

Typical performance characteristics

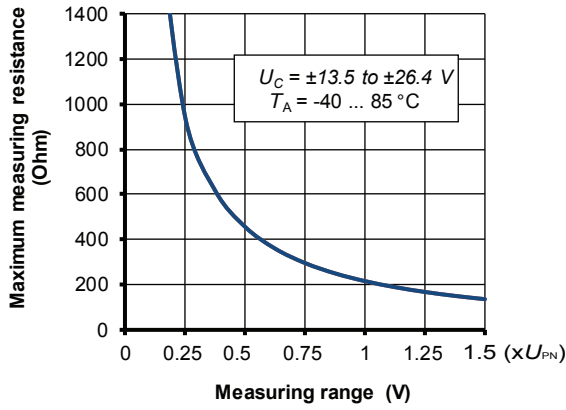

Figure 1: Maximum measuring resistance

$$R_{M,max} = \min \left(\frac{0.02 \times U_{PN} \times (U_C - 1.4) \times 10^3}{U_p} - 25; \frac{0.24 \times U_{PN} \times 10^3}{U_p} - 25 \right) \Omega$$

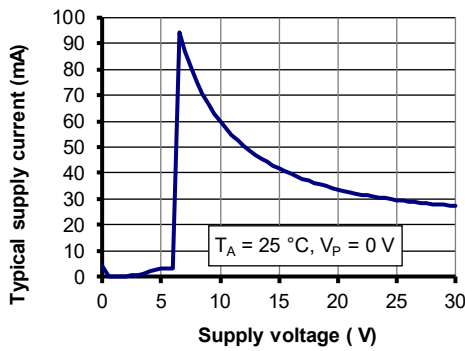

Figure 2: Supply current function of supply voltage

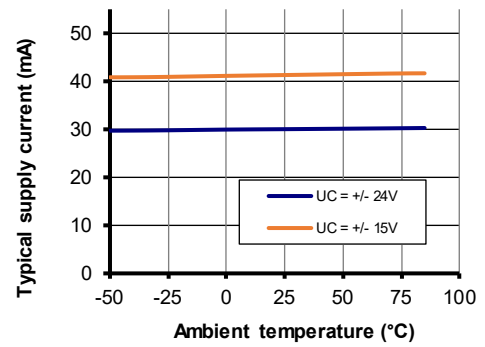

Figure 3: Supply current function of temperature

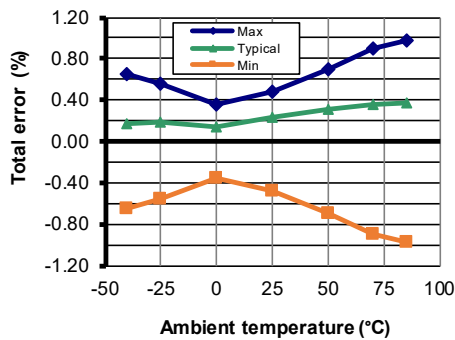

Figure 4: Total error in temperature

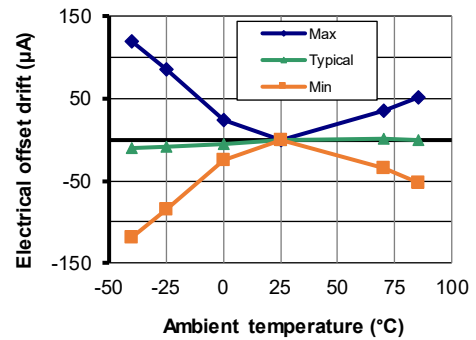

Figure 5: Electrical offset thermal drift

Typical performance characteristics

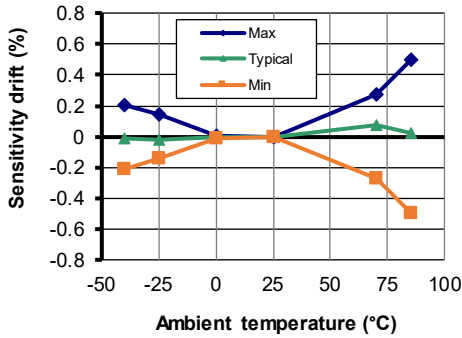

Figure 6: Sensitivity thermal drift

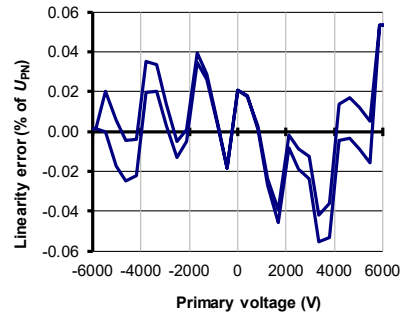

Figure 7: Typical linearity error at 25 °C

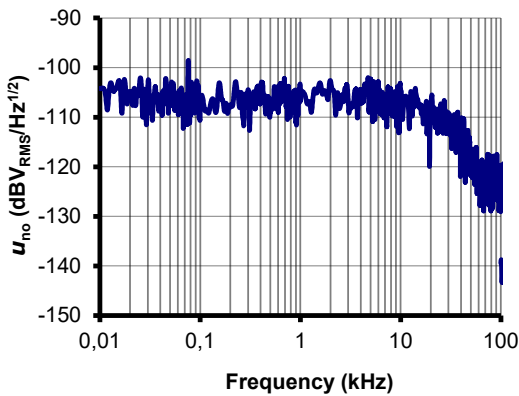

Figure 8: Typical output noise voltage spectral density u_{no} referred to secondary with $R_M = 50 \Omega$

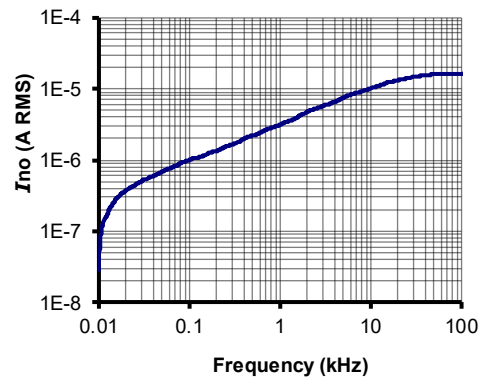

Figure 9: Typical total output RMS noise current I_{no} referred to secondary with $R_M = 50 \Omega$

Figure 8 (output noise voltage spectral density) shows that there are no significant discrete frequencies in the output. Figure 9 confirms the absence of steps in the total output RMS noise current that would indicate discrete frequencies. To calculate the total output RMS noise in a frequency band f_1 to f_2 , the formula is:
with $I_{no}(f)$ read from figure 9 (typical, RMS value).

$$I_{no}(f_1 \text{ to } f_2) = \sqrt{I_{no}(f_2)^2 - I_{no}(f_1)^2}$$

Example:

What is the total output RMS noise from 100 to 1 kHz?
Figure 9 gives $I_{no}(100 \text{ Hz}) = 1.0 \mu\text{A}$ and $I_{no}(1 \text{ kHz}) = 3.13 \mu\text{A}$.

$$\sqrt{(3.13 \times 10^{-6})^2 - (1.0 \times 10^{-6})^2} = 2.97 \mu\text{A}$$

Therefore, the total output RMS noise current is 2.97 μA .

Typical performance characteristics

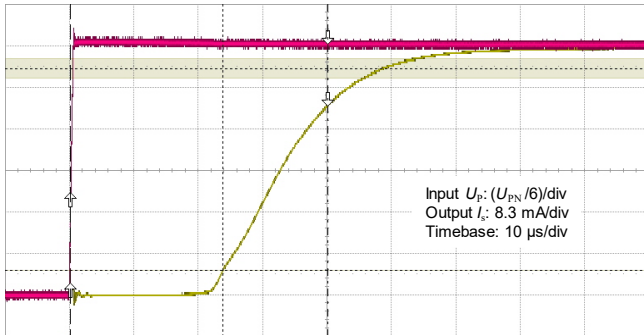

Figure 10: Typical step response (0 to U_{PN})

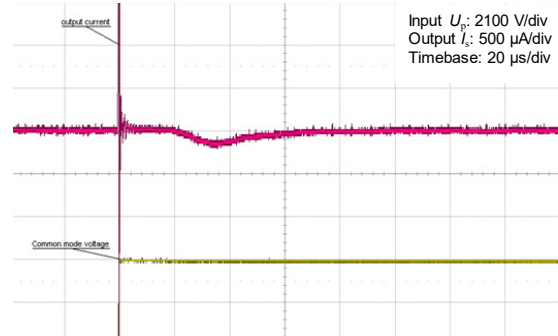

Figure 11: Detail of typical common mode perturbation (4200 V step with $6 \text{ kV}/\mu\text{s}$, $R_M = 100 \Omega$)

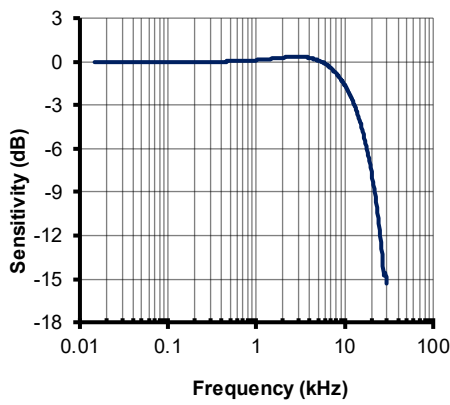

Figure 12: Sensitivity function of frequency

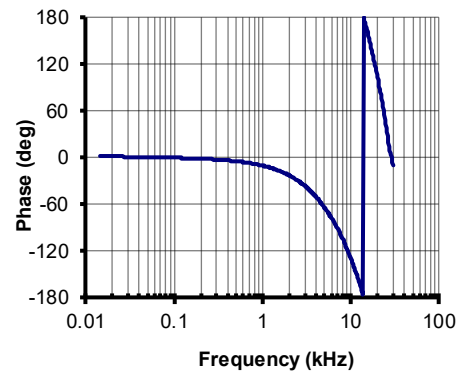

Figure 13: Phase shift function of frequency

Terms and definitions

Simplified transducer model

The static model of the transducer with current output at temperature T_A is:

$$I_S = S \cdot U_P \cdot (1 + \varepsilon)$$

In which (referred to primary):

$$\varepsilon \cdot U_P = U_{OE} + U_{OT} + \varepsilon_s \cdot U_P + \varepsilon_{sT} \cdot U_P + \varepsilon_L(U_{Pmax}) \cdot U_{Pmax}$$

- U_P : primary voltage (V)
- U_{Pmax} : maximum primary voltage applied to the transducer (V)
- I_S : secondary current (A)
- S : sensitivity of the transducer
- TCS : temperature coefficient of S
- T_A : ambient operating temperature (°C)
- U_{OE} : electrical offset voltage (V)
- U_{OT} : temperature variation of U_{OE} (V)
- ε_s : sensitivity error at 25 °C
- ε_{sT} : thermal drift of S
- $\varepsilon_L(U_{Pmax})$: linearity error for U_{Pmax}

This model is valid for primary voltage U_P between $-U_{Pmax}$ and $+U_{Pmax}$ only.

This is the absolute maximum error. As all errors are independent, a more realistic way to calculate the error would be to use the following formula:

$$\varepsilon = \sqrt{\sum_{i=1}^N \varepsilon_i^2}$$

Total error referred to primary

The total error ε_{tot} is the error at $\pm U_{PN}$, relative to the rated value U_{PN} .

It includes all errors mentioned above

- the electrical offset U_{OE}
- the sensitivity error ε_s
- the linearity error ε_L (to U_{PN}).

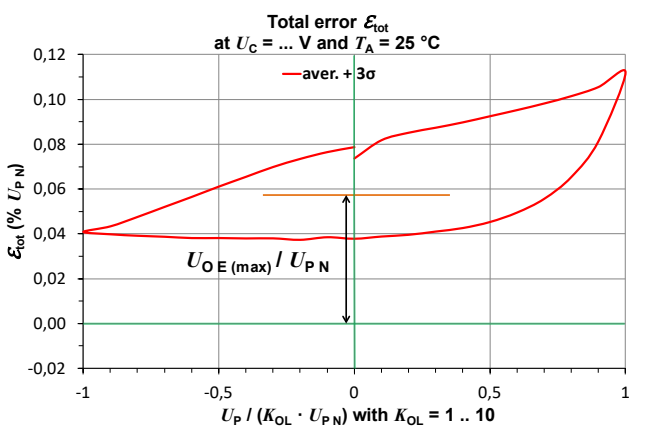
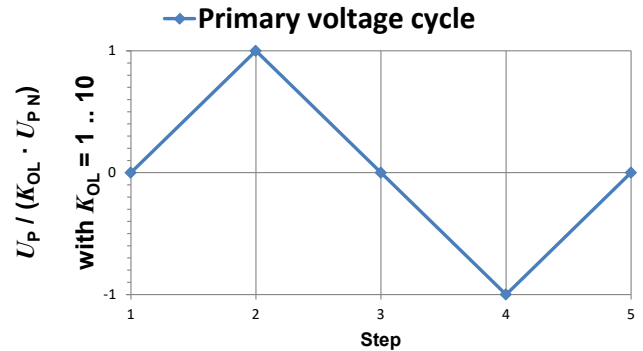

Figure 14: Total error ε_{tot}

Electrical offset referred to primary



K_{OL} : Overload factor

Figure 15: voltage cycle used to measure the electrical offset (transducer supplied)

Using the voltage cycle shown in previous figure, the electrical offset voltage U_{OE} is the residual output referred to primary when the input voltage is zero.

The temperature variation U_{OT} of the electrical offset voltage

$$U_{OE} = \frac{U_{P(3)} + U_{P(5)}}{2}$$

U_{OT} is the variation of the electrical offset from 25 °C to the considered temperature.

$$U_{OT}(T) = U_{OE}(T) - U_{OE}(25^\circ\text{C})$$

Sensitivity and linearity

To measure sensitivity and linearity, the primary voltage (DC) is cycled from 0 to U_P , then to $-U_P$ and back to 0 (equally spaced $U_P/10$ steps). The sensitivity S is defined as the slope of the linear regression line for a cycle between $\pm U_{PN}$.

The linearity error ε_L is the maximum positive or negative difference between the measured points and the linear regression line, expressed in % of U_{PN} .

Delay times

The delay time t_{D10} @ 10 % and the delay time t_{D90} @ 90 % with respect to the primary are shown in the next figure.

Both slightly depend on the primary current di/dt . They are measured at nominal current.

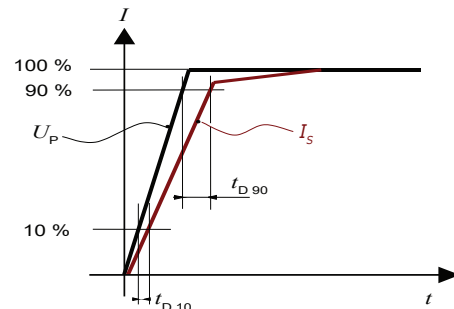
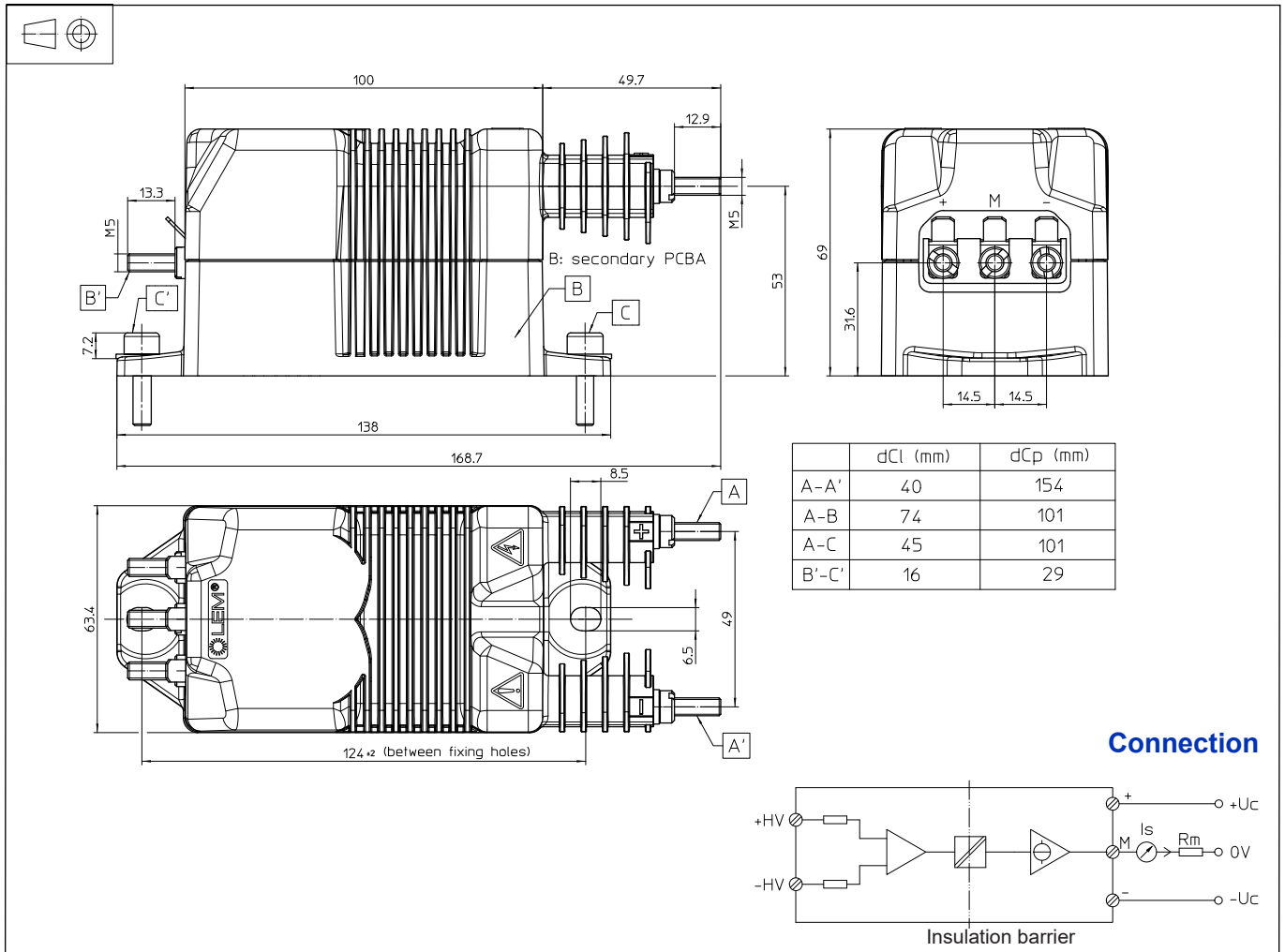

Figure 15: Delay time t_{D10} @ 10 % and delay time t_{D90} @ 90 %.

Dimensions (in mm)



Mechanical characteristics

- General tolerance ± 1 mm
- Transducer fastening
 - 2 holes $\varnothing 6.5$ mm
 - 2 M6 steel screws
 - Recommended fastening torque 5 N·m ± 10 %
- Connection of primary
 - 2 M5 threaded studs
 - Recommended fastening torque 2.2 N·m ± 10 %
- Connection of secondary
 - 3 M5 threaded studs
 - Recommended fastening torque 2.2 N·m ± 10 %

Remarks

- I_s is positive when $U_{HV+} - U_{HV-} > 0$ V.
- The secondary cables also have to be routed together all the way.
- Installation of the transducer must be done unless otherwise specified on the datasheet, according to LEM Transducer Generic Mounting Rules. Please refer to LEM document N°ANE120504 available on our Web site: <https://www.lem.com/en/file/3137/download/>

Note: Additional information available on request.

单击下面可查看定价，库存，交付和生命周期等信息

[>>LEM\(莱姆\)](#)