

Current Transducer HO-NP series

$I_{PN} = 40, 60, 120, 128, 150 \text{ A}$

Ref: HO 40-NP, HO 60-NP, HO 120-NP, HO 128-NP, HO 150-NP

For the electronic measurement of currents: DC, AC, pulsed..., with galvanic separation between the primary circuit and the secondary circuit.

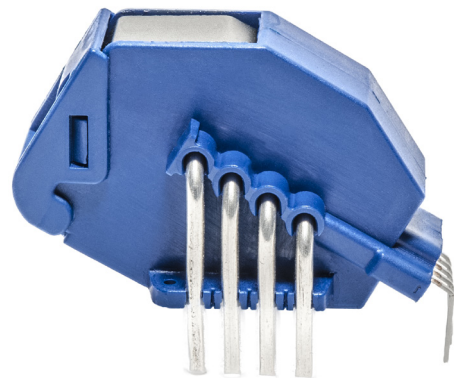

Features

- Open loop multi-range current transducer
- Voltage output
- Single power supply +5 V
- Overcurrent detection $2.93 \times I_{PN}$ (peak value)
- EEPROM Control
- Galvanic separation between primary and secondary circuit
- Low power consumption
- Compact design for THT PCB mounting
- Factory calibrated
- **Dedicated parameter settings available on request (see page 12).**

Advantages

- Low offset drift
- Over-drivable U_{ref}
- 8 mm creepage /clearance
- Fast response.

Applications

- AC variable speed and servo motor drives
- Static converters for DC motor drives
- Battery supplied applications
- Uninterruptible Power Supplies (UPS)
- Switched Mode Power Supplies (SMPS)
- Power supplies for welding applications
- Combiner box
- Solar inverter on DC side of the inverter (MPPT).

Standards

- IEC 61800-1: 1997
- IEC 61800-2: 2015
- IEC 61800-3: 2004
- IEC 61800-5-1: 2007
- IEC 62109-1: 2010
- UL 508: 2013.

Application Domain

- Industrial.

Safety



Caution

If the device is used in a way that is not specified by the manufacturer, the protection provided by the device may be compromised. Always inspect the electronics unit and connecting cable before using this product and do not use it if damaged. Mounting assembly shall guarantee the maximum primary conductor temperature, fulfill clearance and creepage distance, minimize electric and magnetic coupling, and unless otherwise specified can be mounted in any orientation.



Caution, risk of electrical shock

This transducer must be used in limited-energy secondary circuits SELV according to IEC 61010-1, in electric/electronic equipment with respect to applicable standards and safety requirements in accordance with the manufacturer's operating specifications.

Use caution during installation and use of this product; certain parts of the module can carry hazardous voltages and high currents (e.g. power supply, primary conductor).

Ignoring this warning can lead to injury and or/or cause serious damage.

De-energize all circuits and hazardous live parts before installing the product.

All installations, maintenance, servicing operations and use must be carried out by trained and qualified personnel practicing applicable safety precautions.

This transducer is a build-in device, whose hazardous live parts must be inaccessible after installation.

This transducer must be mounted in a suitable end-enclosure.

Besides make sure to have a distance of minimum 30 mm between the primary terminals of the transducer and other neighboring components.

Main supply must be able to be disconnected.

Always inspect the flexible probe for damage before using this product.

Never connect or disconnect the external power supply while the primary circuit is connected to live parts.

Never connect the output to any equipment with a common mode voltage to earth greater than 30 V.

Always wear protective clothing and gloves if hazardous live parts are present in the installation where the measurement is carried out.

This transducer is a built-in device, not intended to be cleaned with any product. Nevertheless if the user must implement cleaning or washing process, validation of the cleaning program has to be done by himself.

When defining soldering process, please use no cleaning process only.



ESD susceptibility

The product is susceptible to be damaged from an ESD event and the personnel should be grounded when handling it.

Do not dispose of this product as unsorted municipal waste. Contact a qualified recycler for disposal.

Although LEM applies utmost care to facilitate compliance of end products with applicable regulations during LEM product design, use of this part may need additional measures on the application side for compliance with regulations regarding EMC and protection against electric shock. Therefore LEM cannot be held liable for any potential hazards, damages, injuries or loss of life resulting from the use of this product.



Underwriters Laboratory Inc. recognized component

Absolute maximum ratings

Parameter	Symbol	Unit	Value
Maximum supply voltage (not destructive)	$U_{C\ max}$	V	8
Maximum supply voltage (not entering non standard modes)	$U_{C\ max}$	V	6.5
Maximum primary conductor temperature	$T_{B\ max}$	°C	120
Electrostatic discharge voltage (HBM - Human Body Model)	$U_{ESD\ HBM}$	kV	2

Stresses above these ratings may cause permanent damage. Exposure to absolute maximum ratings for extended periods may degrade reliability.

UL 508: Ratings and assumptions of certification

File # E189713 Volume: 2 Section: 5

Standards

- CSA C22.2 NO. 14-10 INDUSTRIAL CONTROL EQUIPMENT - Edition 12
- UL 508 STANDARD FOR INDUSTRIAL CONTROL EQUIPMENT - Edition 17

Ratings

Parameter	Symbol	Unit	Value
Primary involved potential		V AC/DC	600
Ambient operating temperature	T_A	°C	105
Primary current	I_P	A	According to series primary current
Secondary supply voltage	U_C	V DC	5
Output voltage	U_{out}	V	0 to 5

Conditions of acceptability

- 1 - These devices have been evaluated for overvoltage category III and for use in pollution degree 2 environment.
- 2 - A suitable enclosure shall be provided in the end-use application.
- 3 - The terminals have not been evaluated for field wiring.
- 4 - These devices are intended to be mounted on a printed wiring board of end use equipment. The suitability of the connections (including spacings) shall be determined in the end-use application.
- 5 - Primary terminals shall not be straightened since assembly of housing case depends upon bending of the terminals.
- 6 - Any surface of polymeric housing have not been evaluated as insulating barrier.
- 7 - Low voltage control circuit shall be supplied by an isolating source (such as a transformer, optical isolator, limiting impedance or electro-mechanical relay).

Marking

Only those products bearing the UR Mark should be considered to be Listed or Recognized and covered under UL's Follow-Up Service. Always look for the Mark on the product.

Insulation coordination

Parameter	Symbol	Unit	Value	Comment
RMS voltage for AC insulation test, 50 Hz, 1 min	U_d	kV	4.3	
Impulse withstand voltage 1.2/50 μ s	U_{Ni}	kV	8	
Partial discharge RMS test voltage ($q_m < 10$ pC)	U_t	V	1500	Primary / Secondary
Clearance (pri. - sec.)	d_{Cl}	mm	> 8	Shortest distance through air
Creepage distance (pri. - sec.)	d_{Cp}	mm	> 8	Shortest path along device body
Clearance (pri. - sec.)		mm	> 8	When mounted on PCB with recommended layout
Case material			V0	According to UL 94
Comparative tracking index	CTI		600	
Application example		V	600	Reinforced insulation, non uniform field according to IEC 61800-5-1, CAT III PD2
Application example		V	1000	Basic insulation non uniform field according to IEC 61800-5-1, CAT III PD2
Application example		V	600	Simple insulation, non uniform field according to UL 508, CAT III PD2

Environmental and mechanical characteristics

Parameter	Symbol	Unit	Min	Typ	Max	Comment
Ambient operating temperature	T_A	°C	-40		105	
Ambient storage temperature	$T_{A\text{st}}$	°C	-40		105	
Mass	m	g		31		

Electrical data HO 40-NP-0100

 At $T_A = 25^\circ\text{C}$, $U_C = +5\text{V}$, $R_L = 10\text{k}\Omega$ unless otherwise noted (see Min, Max, typ. definition paragraph in page 13).

Parameter	Symbol	Unit	Min	Typ	Max	Comment
Primary nominal RMS current	I_{PN}	A		40		
Primary current, measuring range	I_{PM}	A	-100		100	@ $U_C \geq 4.6\text{V}$
Number of primary turns	N_P			1,2,4		See application information
Resistance of primary @ +25 °C	R_P	m Ω		0.09		4 jumpers in parallel
Resistance of primary @ +120 °C	R_P	m Ω		0.12		4 jumpers in parallel
Supply voltage ¹⁾	U_C	V	4.5	5	5.5	
Current consumption	I_C	mA		19	25	
Reference voltage (output)	U_{ref}	V	2.48	2.5	2.52	Internal reference
Reference voltage (input)	U_{ref}	V	0.5		2.65	External reference
Output voltage range @ I_{PM}	$U_{out} - U_{ref}$	V	-2		2	Over operating temperature range
Internal series resistance of reference voltage source	R_{ref}	Ω	130	200	300	Series
Output internal resistance	R_{out}	Ω		2	5	Series
Load capacitance	C_L	nF	0		6	
OCD output on resistance	$R_{on\text{OCD}}$	Ω	70	95	150	Open drain, active low Over operating temperature range
OCD output hold time	$t_{hold\text{OCD}}$	ms	0.7	1	1.4	Additional time after threshold has released
EEPROM control	U_{out}	mV	0		50	U_{out} forced to GND when EEPROM in an error state ²⁾
Electrical offset voltage @ $I_P = 0\text{A}$	U_{OE}	mV	-5		5	$U_{out} - U_{ref}$ @ $U_{ref} = 2.5\text{V}$
Electrical offset current referred to primary	I_{OE}	A	-0.25		0.25	
Temperature coefficient of U_{ref}	TCU_{ref}	ppm/K	-170		170	-40 °C ... 105 °C
Temperature coefficient of U_{OE}	TCU_{OE}	mV/K	-0.075		0.075	-40 °C ... 105 °C
Temperature coefficient of I_{OE} referred to primary @ $I_P = 0\text{A}$	TCI_{OE}	mA/K	-3.75		3.75	-40 °C ... 105 °C
Nominal sensitivity	S_N	mV/A		20		800 mV @ I_{PN}
Sensitivity error @ I_{PN}	ϵ_S	%	-0.75		0.75	Factory adjustment, 1 turn configuration, 4 jumpers in parallel
Temperature coefficient of S	TCS	ppm/K	-200		200	-40 °C ... 105 °C
Linearity error 0 ... I_{PN}	ϵ_L	% of I_{PN}	-0.75		0.75	
Linearity error 0 ... I_{PM}	ϵ_L	% of I_{PM}	-0.5		0.5	
Magnetic offset current (@ $10 \times I_{PN}$) referred to primary	I_{OM}	A	-0.8		0.8	One turn
Delay time to 10 % of the final output value for I_{PN} step	t_{D10}	μs			2	@ 50 A/ μs
Delay time to 90 % of the final output value for I_{PN} step	t_{D90}	μs			2.5	@ 50 A/ μs
Frequency bandwidth (-3 dB)	BW	kHz		350		
Noise voltage spectral density 100 Hz ... 100 kHz	u_{no}	$\mu\text{V}/\sqrt{\text{Hz}}$			16	
RMS noise voltage (DC ... 10 kHz) (DC ... 100 kHz) (DC ... 1 MHz)	U_{no}	mVpp		8 25 46.2		
Primary current, detection threshold	I_{PTh}	A	$2.64 \times I_{PN}$	$2.93 \times I_{PN}$	$3.22 \times I_{PN}$	Peak value $\pm 10\%$, overcurrent detection OCD
Sum of sensitivity and linearity error @ I_{PN}	ϵ_{SL}	% of I_{PN}	-1.5		1.5	
Sum of sensitivity and linearity error at 105° C @ I_{PN}	ϵ_{SL105}	% of I_{PN}	-3.85		3.85	See formula ³⁾
Sum of sensitivity and linearity error at 85° C @ I_{PN}	ϵ_{SL85}	% of I_{PN}	-3.26		3.26	See formula ³⁾

Notes: ¹⁾ 3.3 V SP version available

²⁾ EEPROM in an error state makes the transducer behave like a reverse current saturation. Use of the OCD may help to differentiate the two cases.

³⁾ Sum of sensitivity and linearity error @ T_A (% of I_{PN}) = $\epsilon_{SL} + (\frac{TCS}{10000} \times (T_A - 25) + \frac{TCI_{OE}}{10000 \times I_{PN}} \times 100 \times (T_A - 25))$

Page 5/15

Electrical data HO 60-NP-0100

 At $T_A = 25\text{ °C}$, $U_C = +5\text{ V}$, $R_L = 10\text{ k}\Omega$ unless otherwise noted (see Min, Max, typ. definition paragraph in page 13).

Parameter	Symbol	Unit	Min	Typ	Max	Comment
Primary nominal RMS current	I_{PN}	A		60		
Primary current, measuring range	I_{PM}	A	-150		150	@ $U_C \geq 4.6\text{ V}$
Number of primary turns	N_P			1,2,4		See application information
Resistance of primary @ +25 °C	R_P	m Ω		0.09		4 jumpers in parallel
Resistance of primary @ +120 °C	R_P	m Ω		0.12		4 jumpers in parallel
Supply voltage ¹⁾	U_C	V	4.5	5	5.5	
Current consumption	I_C	mA		19	25	
Reference voltage (output)	U_{ref}	V	2.48	2.5	2.52	Internal reference
Reference voltage (input)	U_{ref}	V	0.5		2.65	External reference
Output voltage range @ I_{PM}	$U_{out} - U_{ref}$	V	-2		2	Over operating temperature range
Internal series resistance of reference voltage source	R_{ref}	Ω	130	200	300	Series
Output internal resistance	R_{out}	Ω		2	5	Series
Load capacitance	C_L	nF	0		6	
OCD output on resistance	R_{onOCD}	Ω	70	95	150	Open drain, active low, Over operating temperature range
OCD output hold time	$t_{holdOCD}$	ms	0.7	1	1.4	Additional time after threshold has released
EEPROM control	U_{out}	mV	0		50	U_{out} forced to GND when EEPROM in an error state ²⁾
Electrical offset voltage @ $I_P = 0\text{ A}$	U_{OE}	mV	-5		5	$U_{out} - U_{ref}$ @ $U_{ref} = 2.5\text{ V}$
Electrical offset current referred to primary	I_{OE}	A	-0.375		0.375	
Temperature coefficient of U_{ref}	TCU_{ref}	ppm/K	-170		170	-40 °C ... 105 °C
Temperature coefficient of U_{OE}	TCU_{OE}	mV/K	-0.075		0.075	-40 °C ... 105 °C
Temperature coefficient of I_{OE} referred to primary @ $I_P = 0\text{ A}$	TCI_{OE}	mA/K	-5.625		5.625	-40 °C ... 105 °C
Nominal sensitivity	S_N	mV/A		13.333		800 mV @ I_{PN}
Sensitivity error @ I_{PN}	ϵ_S	%	-0.75		0.75	Factory adjustment, 1 turn configuration, 4 jumpers in parallel
Temperature coefficient of S	TCS	ppm/K	-200		200	-40 °C ... 105 °C
Linearity error 0 ... I_{PN}	ϵ_L	% of I_{PN}	-0.65		0.65	
Linearity error 0 ... I_{PM}	ϵ_L	% of I_{PM}	-0.5		0.5	
Magnetic offset current (@ $10 \times I_{PN}$) referred to primary	I_{OM}	A	-0.8		0.8	One turn
Delay time to 10 % of the final output value for I_{PN} step	t_{D10}	μs			2	@ 50 A/ μs
Delay time to 90 % of the final output value for I_{PN} step	t_{D90}	μs			2.5	@ 50 A/ μs
Frequency bandwidth (-3 dB)	BW	kHz		350		
Noise voltage spectral density 100 Hz ... 100 kHz	u_{no}	$\mu\text{V}/\sqrt{\text{Hz}}$			11	
RMS noise voltage (DC ... 10 kHz) (DC ... 100 kHz) (DC ... 1 MHz)	U_{no}	mVpp		5.7 16.5 31.1		
Primary current, detection threshold	I_{PTh}	A	$2.64 \times I_{PN}$	$2.93 \times I_{PN}$	$3.22 \times I_{PN}$	Peak value $\pm 10\%$, overcurrent detection OCD
Sum of sensitivity and linearity error @ I_{PN}	ϵ_{SL}	% of I_{PN}	-1.4		1.4	
Sum of sensitivity and linearity error at 105 °C @ I_{PN}	ϵ_{SL105}	% of I_{PN}	-3.75		3.75	See formula ³⁾
Sum of sensitivity and linearity error at 85 °C @ I_{PN}	ϵ_{SL85}	% of I_{PN}	-3.16		3.16	See formula ³⁾

Notes: ¹⁾ 3.3 V SP version available

²⁾ EEPROM in an error state makes the transducer behave like a reverse current saturation. Use of the OCD may help to differentiate the two cases.

³⁾ Sum of sensitivity and linearity error @ T_A (% of I_{PN}) = $\epsilon_{SL} + \left(\frac{TCS}{10000} \times (T_A - 25) + \frac{TCI_{OE}}{10000 \times I_{PN}} \times 100 \times (T_A - 25) \right)$

Electrical data HO 120-NP-0100

 At $T_A = 25\text{ °C}$, $U_C = +5\text{ V}$, $R_L = 10\text{ k}\Omega$ unless otherwise noted (see Min, Max, typ. definition paragraph in page 13).

Parameter	Symbol	Unit	Min	Typ	Max	Comment
Primary nominal RMS current	I_{PN}	A		120		
Primary current, measuring range	I_{PM}	A	-300		300	@ $U_C \geq 4.6\text{ V}$
Number of primary turns	N_P			1,2,4		See application information
Resistance of primary @ +25 °C	R_P	m Ω		0.09		4 jumpers in parallel
Resistance of primary @ +120 °C	R_P	m Ω		0.12		4 jumpers in parallel
Supply voltage ¹⁾	U_C	V	4.5	5	5.5	
Current consumption	I_C	mA		19	25	
Reference voltage (output)	U_{ref}	V	2.48	2.5	2.52	Internal reference
Reference voltage (input)	U_{ref}	V	0.5		2.65	External reference
Output voltage range @ I_{PM}	$U_{out} - U_{ref}$	V	-2		2	Over operating temperature range
Internal series resistance of reference voltage	R_{ref}	Ω	130	200	300	Series
Output internal resistance	R_{out}	Ω		2	5	Series
Load capacitance	C_L	nF	0		6	
OCD output on resistance	$R_{on\text{OCD}}$	Ω	70	95	150	Open drain, active low, Over operating temperature range
OCD output hold time	$t_{hold\text{OCD}}$	ms	0.7	1	1.4	Additional time after threshold has released
EEPROM control	U_{out}	mV	0		50	U_{out} forced to GND when EEPROM in an error state ²⁾
Electrical offset voltage @ $I_P = 0\text{ A}$	U_{OE}	mV	-5		5	$U_{out} - U_{ref}$ @ $U_{ref} = 2.5\text{ V}$
Electrical offset current Referred to primary	I_{OE}	A	-0.75		0.75	
Temperature coefficient of U_{ref}	TCU_{ref}	ppm/K	-170		170	-40 °C ... 105 °C
Temperature coefficient of U_{OE}	TCU_{OE}	mV/K	-0.075		0.075	-40 °C ... 105 °C
Temperature coefficient of I_{OE} referred to primary @ $I_P = 0\text{ A}$	TCI_{OE}	mA/K	-11.25		11.25	-40 °C ... 105 °C
Nominal sensitivity	S_N	mV/A		6.667		800 mV @ I_{PN}
Sensitivity error @ I_{PN}	ε_S	%	-0.75		0.75	Factory adjustment, 1 turn configuration, 4 jumpers in parallel
Temperature coefficient of S	TCS	ppm/K	-200		200	-40 °C ... 105 °C
Linearity error 0 ... I_{PN}	ε_L	% of I_{PN}	-0.5		0.5	
Linearity error 0 ... I_{PM}	ε_L	% of I_{PM}	-0.5		0.5	
Magnetic offset current (@ $10 \times I_{PN}$) referred to primary	I_{OM}	A	-0.8		0.8	One turn
Delay time to 10 % of I_{PN}	t_{D10}	μs			2	@ 50 A/ μs
Delay time to 90 % of I_{PN}	t_{D90}	μs			2.5	@ 50 A/ μs
Frequency bandwidth (-3 dB)	BW	kHz		350		
Noise voltage spectral density 100 Hz ... 100 kHz	u_{no}	$\mu\text{V}/\sqrt{\text{Hz}}$			6.1	
RMS noise voltage (DC ... 10 kHz) (DC ... 100 kHz) (DC ... 1 MHz)	U_{no}	mVpp		3.6 8.9 17.1		
Primary current, detection threshold	I_{PTh}	A	$2.64 \times I_{PN}$	$2.93 \times I_{PN}$	$3.22 \times I_{PN}$	Peak value $\pm 10\%$, overcurrent detection OCD
Sum of sensitivity and linearity @ I_{PN}	ε_{SL}	% of I_{PN}	-1.25		1.25	
Sum of sensitivity and linearity @ I_{PN} @ $T_A = +105\text{ °C}$	ε_{SL}	% of I_{PN}	-3.60		3.60	See formula ³⁾
Sum of sensitivity and linearity @ I_{PN} @ $T_A = +85\text{ °C}$	ε_{SL}	% of I_{PN}	-3.01		3.01	See formula ³⁾

Notes: ¹⁾ 3.3 V SP version available

²⁾ EEPROM in an error state makes the transducer behave like a reverse current saturation. Use of the OCD may help to differentiate the two cases.

³⁾ Sum of sensitivity and linearity error @ T_A (% of I_{PN}) = $\varepsilon_{SL} + \left(\frac{TCS}{10000} \times (T_A - 25) + \frac{TCI_{OE}}{10000 \times I_{PN}} \times 100 \times (T_A - 25) \right)$

Electrical data HO 128-NP-0100

 At $T_A = 25\text{ °C}$, $U_C = +5\text{ V}$, $R_L = 10\text{ k}\Omega$ unless otherwise noted (see Min, Max, typ. definition paragraph in page 13).

Parameter	Symbol	Unit	Min	Typ	Max	Comment
Primary nominal RMS current	I_{PN}	A		128		
Primary current, measuring range	I_{PM}	A	-320		320	@ $U_C \geq 4.6\text{ V}$
Number of primary turns	N_p			1,2,4		See application information
Resistance of primary @ +25 °C	R_p	m Ω		0.09		4 jumpers in parallel
Resistance of primary @ +120 °C	R_p	m Ω		0.12		4 jumpers in parallel
Supply voltage ¹⁾	U_C	V	4.5	5	5.5	
Current consumption	I_C	mA		19	25	
Reference voltage (output)	U_{ref}	V	2.48	2.5	2.52	Internal reference
Reference voltage (input)	U_{ref}	V	0.5		2.65	External reference
Output voltage range @ I_{PM}	$U_{out} - U_{ref}$	V	-2		2	Over operating temperature range
Internal series resistance of reference voltage	R_{ref}	Ω	130	200	300	Series
Output internal resistance	R_{out}	Ω		2	5	Series
Load capacitance	C_L	nF	0		6	
OCD output on resistance	$R_{on\text{OCD}}$	Ω	70	95	150	Open drain, active low, Over operating temperature range
OCD output hold time	$t_{hold\text{OCD}}$	ms	0.7	1	1.4	Additional time after threshold has released
EEPROM control	U_{out}	mV	0		50	U_{out} forced to GND when EEPROM in an error state ²⁾
Electrical offset voltage @ $I_p = 0\text{ A}$	U_{OE}	mV	-5		5	$U_{out} - U_{ref}$ @ $U_{ref} = 2.5\text{ V}$
Electrical offset current Referred to primary	I_{OE}	A	-0.8		0.8	
Temperature coefficient of U_{ref}	TCU_{ref}	ppm/K	-170		170	-40 °C ... 105 °C
Temperature coefficient of U_{OE}	TCU_{OE}	mV/K	-0.075		0.075	-40 °C ... 105 °C
Temperature coefficient of I_{OE} referred to primary @ $I_p = 0\text{ A}$	TCI_{OE}	mA/K	-12		12	-40 °C ... 105 °C
Nominal sensitivity	S_N	mV/A		6.25		800 mV @ I_{PN}
Sensitivity error @ I_{PN}	ε_S	%	-0.75		0.75	Factory adjustment, 1 turn configuration, 4 jumpers in parallel
Temperature coefficient of S	TCS	ppm/K	-200		200	-40 °C ... 105 °C
Linearity error 0 ... I_{PN}	ε_L	% of I_{PN}	-0.5		0.5	
Linearity error 0 ... I_{PM}	ε_L	% of I_{PM}	-0.5		0.5	
Magnetic offset current (@ $10 \times I_{PN}$) referred to primary	I_{OM}	A	-0.8		0.8	One turn
Delay time to 10 % of I_{PN}	t_{D10}	μs			2	@ 50 A/ μs
Delay time to 90 % of I_{PN}	t_{D90}	μs			2.5	@ 50 A/ μs
Frequency bandwidth (-3 dB)	BW	kHz		350		
Noise voltage spectral density 100 Hz ... 100 kHz	u_{no}	$\mu\text{V}/\sqrt{\text{Hz}}$			5.7	
RMS noise voltage (DC ... 10 kHz) (DC ... 100 kHz) (DC ... 1 MHz)	U_{no}	mVpp		3.5 8.4 16.5		
Primary current, detection threshold	I_{PTh}	A	$2.64 \times I_{PN}$	$2.93 \times I_{PN}$	$3.22 \times I_{PN}$	Peak value $\pm 10\%$, overcurrent detection OCD
Sum of sensitivity and linearity @ I_{PN}	ε_{SL}	% of I_{PN}	-1.25		1.25	
Sum of sensitivity and linearity @ I_{PN} @ $T_A = +105\text{ °C}$	ε_{SL}	% of I_{PN}	-3.60		3.60	See formula ³⁾
Sum of sensitivity and linearity @ I_{PN} @ $T_A = +85\text{ °C}$	ε_{SL}	% of I_{PN}	-3.01		3.01	See formula ³⁾

Notes: ¹⁾ 3.3 V SP version available

²⁾ EEPROM in an error state makes the transducer behave like a reverse current saturation. Use of the OCD may help to differentiate the two cases.

³⁾ Sum of sensitivity and linearity error @ T_A (% of I_{PN}) = $\varepsilon_{SL} + (-\frac{TCS}{10000} \times (T_A - 25) + \frac{TCI_{OE}}{10000 \times I_{PN}} \times 100 \times (T_A - 25))$

Electrical data HO 150-NP-0100

 At $T_A = 25^\circ\text{C}$, $U_C = +5\text{ V}$, $R_L = 10\text{ k}\Omega$ unless otherwise noted (see Min, Max, typ. definition paragraph in page 13).

Parameter	Symbol	Unit	Min	Typ	Max	Comment
Primary nominal RMS current	I_{PN}	A		150		
Primary current, measuring range $85^\circ\text{C}^{1)}$ 105°C	I_{PM}	A	-375 -360		375 360	@ $U_C \geq 4.6\text{ V}$
Number of primary turns	N_P			1,2,4		See application information
Resistance of primary @ $+25^\circ\text{C}$	R_P	m Ω		0.09		4 jumpers in parallel
Resistance of primary @ $+120^\circ\text{C}$	R_P	m Ω		0.12		4 jumpers in parallel
Supply voltage ²⁾	U_C	V	4.5	5	5.5	
Current consumption	I_C	mA		19	25	
Reference voltage (output)	U_{ref}	V	2.48	2.5	2.52	Internal reference
Reference voltage (input)	U_{ref}	V	0.5		2.65	External reference
Output voltage range @ I_{PM}	$U_{out} - U_{ref}$	V	-2		2	Over operating temperature range
Internal series resistance of reference voltage	R_{ref}	Ω	130	200	300	Series
Output internal resistance	R_{out}	Ω		2	5	Series
Load capacitance	C_L	nF	0		6	
OCD output on resistance	$R_{on\text{OCD}}$	Ω	70	95	150	Open drain, active low, Over operating temperature range
OCD output hold time	$t_{hold\text{OCD}}$	ms	0.7	1	1.4	Additional time after threshold has released
EEPROM control	U_{out}	mV	0		50	U_{out} forced to GND when EEPROM in an error state ³⁾
Electrical offset voltage @ $I_P = 0\text{ A}$	U_{OE}	mV	-5		5	$U_{out} - U_{ref}$ @ $U_{ref} = 2.5\text{ V}$
Electrical offset current Referred to primary	I_{OE}	A	-0.9375		0.9375	
Temperature coefficient of U_{ref}	TCU_{ref}	ppm/K	-170		170	$-40^\circ\text{C} \dots 105^\circ\text{C}$
Temperature coefficient of U_{OE}	TCU_{OE}	mV/K	-0.075		0.075	$-40^\circ\text{C} \dots 105^\circ\text{C}$
Temperature coefficient of I_{OE} referred to primary @ $I_P = 0\text{ A}$	TCI_{OE}	mA/K	-14.0625		14.0625	$-40^\circ\text{C} \dots 105^\circ\text{C}$
Nominal sensitivity	S_N	mV/A		5.333		800 mV @ I_{PN}
Sensitivity error @ I_{PN}	ϵ_S	%	-0.75		0.75	Factory adjustment, 1 turn configuration, 4 jumpers in parallel
Temperature coefficient of S	TCS	ppm/K	-200		200	$-40^\circ\text{C} \dots 105^\circ\text{C}$
Linearity error 0 ... I_{PN}	ϵ_L	% of I_{PN}	-0.4		0.4	
Linearity error 0 ... I_{PM}	ϵ_L	% of I_{PM}	-0.5		0.5	
Magnetic offset current (@ $10 \times I_{PN}$) referred to primary	I_{OM}	A	-0.8		0.8	One turn
Delay time to 10 % of I_{PN}	t_{D10}	μs			2	@ 50 A/ μs
Delay time to 90 % of I_{PN}	t_{D90}	μs			2.5	@ 50 A/ μs
Frequency bandwidth (-3 dB)	BW	kHz		350		
Noise voltage spectral density 100 Hz ... 100 kHz	u_{no}	$\mu\text{V}/\sqrt{\text{Hz}}$			5.2	
RMS noise voltage (DC ... 10 kHz) (DC ... 100 kHz) (DC ... 1 MHz)	U_{no}	mVpp		3.2 7 15.3		
Primary current, detection threshold	I_{PTh}	A	$2.64 \times I_{PN}$	$2.93 \times I_{PN}$	$3.22 \times I_{PN}$	Peak value $\pm 10\%$, overcurrent detection OCD
Sum of sensitivity and linearity @ I_{PN}	ϵ_{SL}	% of I_{PN}	-1.15		1.15	
Sum of sensitivity and linearity @ I_{PN} @ $T_A = +105^\circ\text{C}$	ϵ_{SL}	% of I_{PN}	-3.50		3.50	See formula ⁴⁾
Sum of sensitivity and linearity @ I_{PN} @ $T_A = +85^\circ\text{C}$	ϵ_{SL}	% of I_{PN}	-2.91		2.91	See formula ⁴⁾

Notes: ¹⁾ Magnetic core temperature remaining equal or less than ambient temperature T_A
²⁾ 3.3 V SP version available

³⁾ EEPROM in an error state makes the transducer behave like a reverse current saturation. Use of the OCD may help to differentiate the two cases

⁴⁾ Sum of sensitivity and linearity error @ T_A (% of I_{PN}) = $\epsilon_{SL} + (\frac{TCS}{10000} \times (T_A - 25) + \frac{TCI_{OE}}{10000 \times I_{PN}} \times 100 \times (T_A - 25))$

HO-NP series, measuring range versus external reference voltage

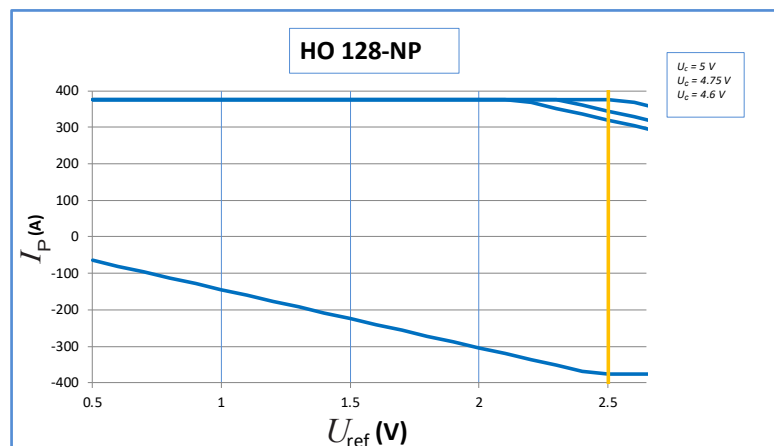
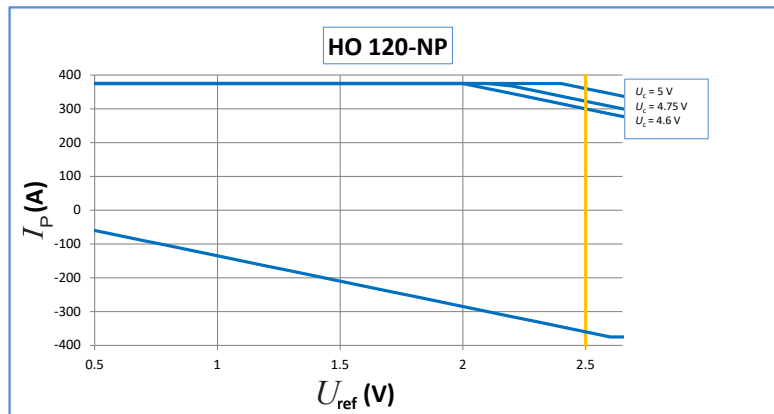
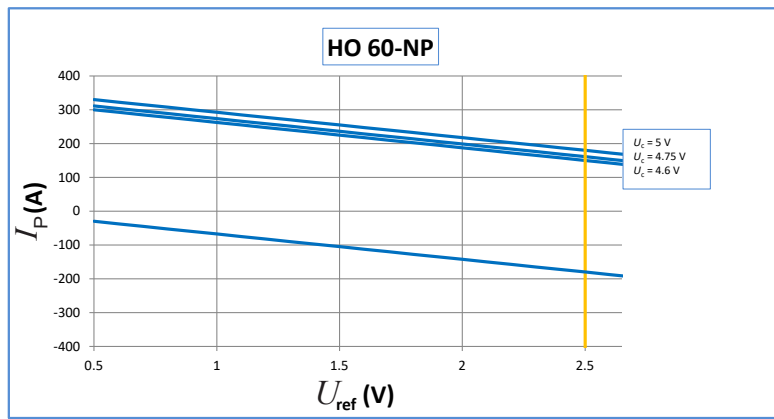
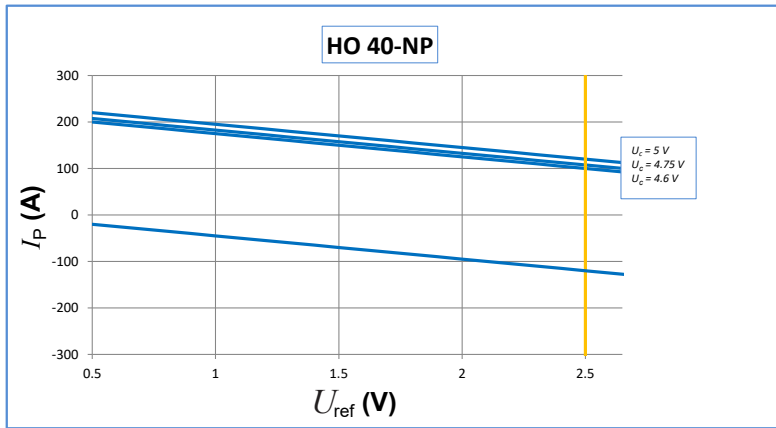

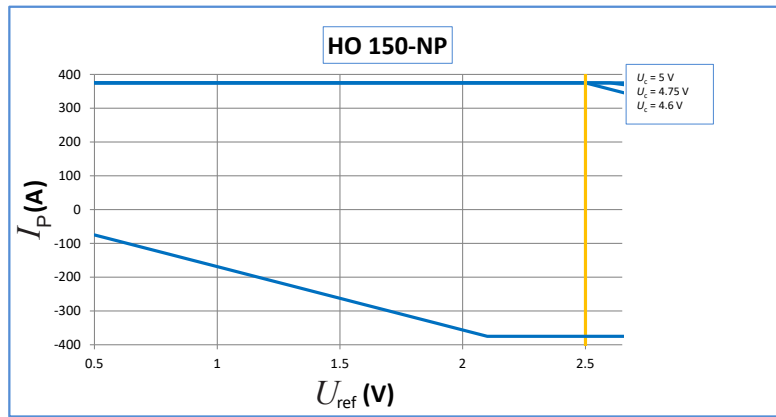

Maximum continuous DC current

For all ranges:

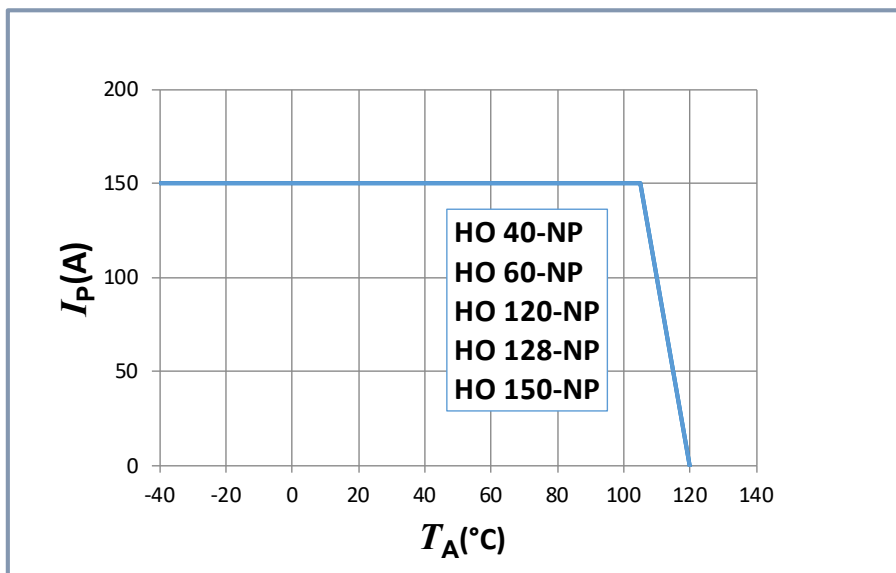

Important Notice: Whatever the usage and/or application, the transducer jumper temperature shall not go above the maximum rating of 120 °C as stated in page 3 of this datasheet.

HO-NP series: name and codification

HO family products may be ordered **on request** ¹⁾ with a dedicated setting of the parameters as described below (standard products are delivered with the setting 0100 according to the table).

HO-NP-XXXX

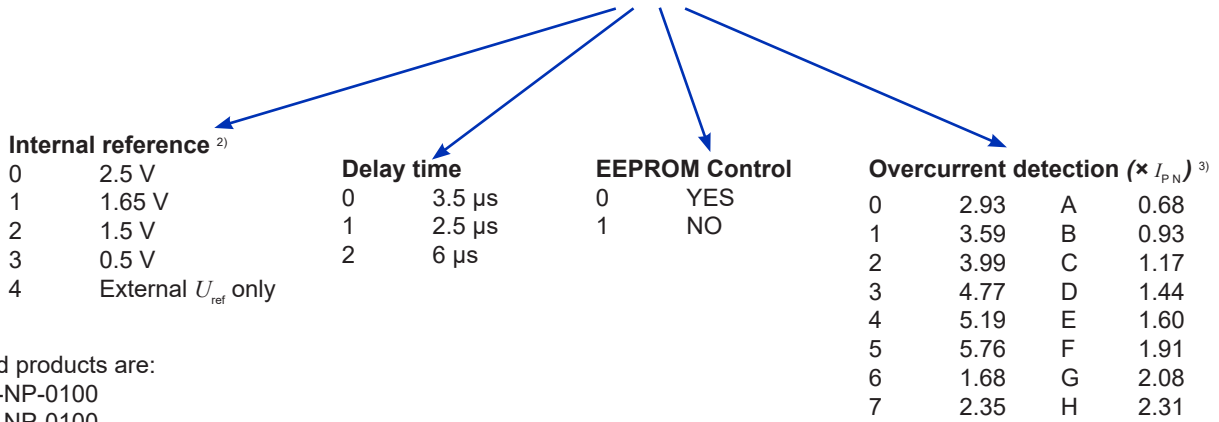

- Standard products are:
- HO 40-NP-0100
 - HO 60-NP-0100
 - HO 120-NP-0100
 - HO 128-NP-0100
 - HO 150-NP-0100

Notes: ¹⁾ For dedicated settings, minimum quantities apply, please contact your local LEM support.
²⁾ U_{ref} electrical data

U_{ref} parameter	U_{ref} (V)			TCU_{ref} (ppm/K)	
	min	typ	max	min	max
0	2.48	2.5	2.52	-170	170
1	1.63	1.65	1.67	-170	170
2	1.48	1.5	1.52	-170	170
3	0.49	0.5	0.51	-250	250

³⁾ OCD ($\times I_{PN}$) correction table versus range and temperature
 All other values or empty cells: no change

HO-NP-010x				
OCD Parameter	I_{PN} (A) @ 25 °C			
	40	60	120	150
A				
B				
C				
D				
E				
6				
F				
G				
H				
7				
0				
1				4.19
2				6.17
3				6.17
4			5.71	-
5			7.16	-

HO-NP-010x				
OCD Parameter	I_{PN} (A) @ 85 °C			
	40	60	120	150
A				
B				
C				
D				
E				
6				
F				
G				
H				
7				
0				
1				4.05
2			4.01	5.00
3			5.72	-
4			6.77	-
5			-	-

HO-NP-010x				
OCD Parameter	I_{PN} (A) @ 105 °C			
	40	60	120	150
A				
B				
C				
D				
E				
6				
F				
G				
H				
7				
0				2.98
1				4.39
2			4.38	5.38
3			6.17	-
4			7.26	-
5			-	-

Tolerance on OCD value	
±20 %	
±15 %	
±10 %	No change
-	Do not use

HO-NP series: output compatibility with HAIS Series

Reference	I_{PN} (A)	I_{PM} (A)	$\frac{I_{PM}}{I_{PN}}$	$\frac{U_{out} - U_{ref}}{I_{PN}}$ (V)	Reference	I_{PN} (A)	I_{PM} (A)	$\frac{I_{PM}}{I_{PN}}$	$\frac{U_{out} - U_{ref}}{I_{PN}}$ (V)
HO 40-NP	40	100	2.5	0.8					
HO 60-NP	60	150	2.5	0.8	HAIS 50-TP	50	150	3	0.625
HO 120-NP	120	300	2.5	0.8					
HO 128-NP	128	320	2.5	0.8	HAIS 100-TP	100	300	3	0.625
HO 150-NP	150	375	2.5	0.8					

The HO-NP gives the same output levels as the HAIS-TP referring to the HAIS nominal currents. This allows easier replacement of HAIS by HO-NP in existing applications.

Application information

Number of primary turns	Primary current				
	$I_{PN} = 40$ A	$I_{PN} = 60$ A	$I_{PN} = 120$ A	$I_{PN} = 128$ A	$I_{PN} = 150$ A
1	40 A	60 A	120 A	128 A	150 A
2	20 A	30 A	60 A	64 A	75 A
4	10 A	15 A	30 A	32 A	37.5 A

Possibilities between range selection and number of turns ¹⁾²⁾

Connection diagram

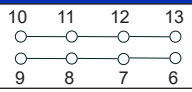
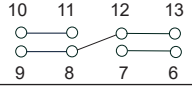
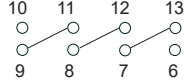
Number of primary turns	Primary resistance current RMS R_p (mΩ) @ $T_A = 25$ °C	Recommended connections
1	0.09	
2	0.36	
4	1.45	

Notes: ¹⁾ The standard configuration is with all jumpers in parallel (1 primary turn) which is the only one calibrated and guaranteed by LEM. The sensitivity may change slightly for all other configurations, therefore, LEM advises the user to characterize any specific configuration.

²⁾ The maximum magnetic offset referred to primary is inversely proportional to the number of turns, thus is divided by 2 with 2 turns and by 4 with 4 turns.

Definition of typical, minimum and maximum values

Minimum and maximum values for specified limiting and safety conditions have to be understood as such as well as values shown in “typical” graphs.

On the other hand, measured values are part of a statistical distribution that can be specified by an interval with upper and lower limits and a probability for measured values to lie within this interval.

Unless otherwise stated (e.g. “100 % tested”), the LEM definition for such intervals designated with “min” and “max” is that the probability for values of samples to lie in this interval is 99.73 %.

For a normal (Gaussian) distribution, this corresponds to an interval between -3 sigma and +3 sigma. If “typical” values are not obviously mean or average values, those values are defined to delimit intervals with a probability of 68.27 %, corresponding to an interval between -sigma and +sigma for a normal distribution.

Typical, maximal and minimal values are determined during the initial characterization of the product.

Remark

Installation of the transducer must be done unless otherwise specified on the datasheet, according to LEM Transducer Generic Mounting Rules. Please refer to LEM document N°ANE120504 available on our Web site: <https://www.lem.com/en/file/3137/download/>.

Dimensions HO-NP series (in mm, general linear tolerance ± 0.3 mm)

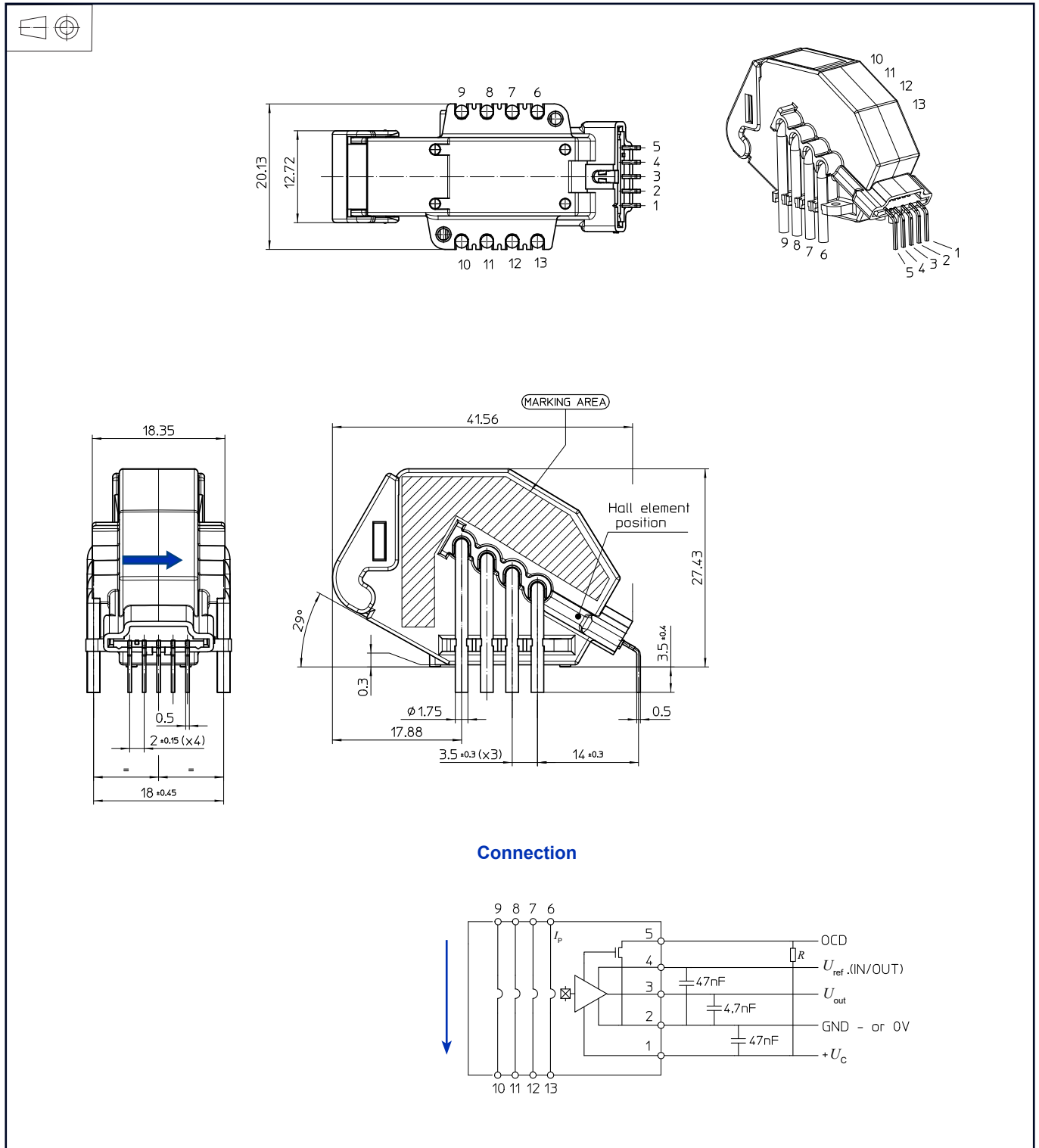

Remark:

- U_{out} is positive with respect to U_{ref} when positive I_p flows in direction of the arrow shown on the drawing above.

单击下面可查看定价，库存，交付和生命周期等信息

[>>LEM\(莱姆\)](#)