

## Current Transducer HO-NP series

$I_{PN} = 40, 60, 120, 128, 150 \text{ A}$

Ref: HO 40-NP, HO 60-NP, HO 120-NP, HO 128-NP, HO 150-NP

For the electronic measurement of currents: DC, AC, pulsed..., with galvanic separation between the primary circuit and the secondary circuit.

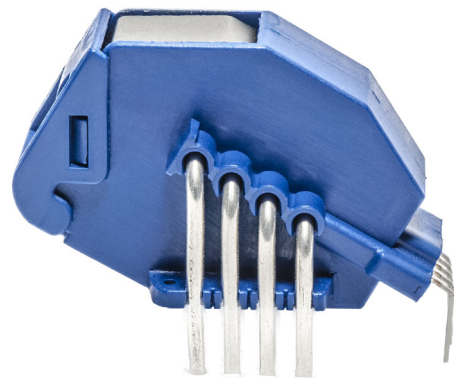

### Features

- Open loop multi-range current transducer
- Voltage output
- Single power supply +5 V
- Overcurrent detection  $2.93 \times I_{PN}$  (peak value)
- EEPROM Control
- Galvanic separation between primary and secondary circuit
- Low power consumption
- Compact design for THT PCB mounting
- Factory calibrated
- **Dedicated parameter settings available on request (see page 12).**

### Advantages

- Low offset drift
- Over-drivable  $U_{ref}$
- 8 mm creepage /clearance
- Fast response.

### Applications

- AC variable speed and servo motor drives
- Static converters for DC motor drives
- Battery supplied applications
- Uninterruptible Power Supplies (UPS)
- Switched Mode Power Supplies (SMPS)
- Power supplies for welding applications
- Combiner box
- Solar inverter on DC side of the inverter (MPPT).

### Standards

- IEC 61800-1: 1997
- IEC 61800-2: 2015
- IEC 61800-3: 2004
- IEC 61800-5-1: 2007
- IEC 62109-1: 2010
- UL 508: 2013.

### Application Domain

- Industrial.

**Safety**

Caution

If the device is used in a way that is not specified by the manufacturer, the protection provided by the device may be compromised. Always inspect the electronics unit and connecting cable before using this product and do not use it if damaged. Mounting assembly shall guarantee the maximum primary conductor temperature, fulfill clearance and creepage distance, minimize electric and magnetic coupling, and unless otherwise specified can be mounted in any orientation.



Caution, risk of electrical shock

This transducer must be used in limited-energy secondary circuits SELV according to IEC 61010-1, in electric/electronic equipment with respect to applicable standards and safety requirements in accordance with the manufacturer's operating specifications.

Use caution during installation and use of this product; certain parts of the module can carry hazardous voltages and high currents (e.g. power supply, primary conductor).

Ignoring this warning can lead to injury and or/or cause serious damage.

De-energize all circuits and hazardous live parts before installing the product.

All installations, maintenance, servicing operations and use must be carried out by trained and qualified personnel practicing applicable safety precautions.

This transducer is a build-in device, whose hazardous live parts must be inaccessible after installation.

This transducer must be mounted in a suitable end-enclosure.

Besides make sure to have a distance of minimum 30 mm between the primary terminals of the transducer and other neighboring components.

Main supply must be able to be disconnected.

Always inspect the flexible probe for damage before using this product.

Never connect or disconnect the external power supply while the primary circuit is connected to live parts.

Never connect the output to any equipment with a common mode voltage to earth greater than 30 V.

Always wear protective clothing and gloves if hazardous live parts are present in the installation where the measurement is carried out.

This transducer is a built-in device, not intended to be cleaned with any product. Nevertheless if the user must implement cleaning or washing process, validation of the cleaning program has to be done by himself.

When defining soldering process, please use no cleaning process only.



ESD susceptibility

The product is susceptible to be damaged from an ESD event and the personnel should be grounded when handling it.

Do not dispose of this product as unsorted municipal waste. Contact a qualified recycler for disposal.

Although LEM applies utmost care to facilitate compliance of end products with applicable regulations during LEM product design, use of this part may need additional measures on the application side for compliance with regulations regarding EMC and protection against electric shock. Therefore LEM cannot be held liable for any potential hazards, damages, injuries or loss of life resulting from the use of this product.



Underwriters Laboratory Inc. recognized component

## Absolute maximum ratings

| Parameter  | Symbol         | Unit | Value |
|--|----------------|------|-------|
| Maximum supply voltage (not destructive)                 | $U_{C\ max}$   | V    | 8     |
| Maximum supply voltage (not entering non standard modes) | $U_{C\ max}$   | V    | 6.5   |
| Maximum primary conductor temperature                    | $T_{B\ max}$   | °C   | 120   |
| Electrostatic discharge voltage (HBM - Human Body Model) | $U_{ESD\ HBM}$ | kV   | 2     |

Stresses above these ratings may cause permanent damage. Exposure to absolute maximum ratings for extended periods may degrade reliability.

## UL 508: Ratings and assumptions of certification

File # E189713 Volume: 2 Section: 5

### Standards

- CSA C22.2 NO. 14-10 INDUSTRIAL CONTROL EQUIPMENT - Edition 12
- UL 508 STANDARD FOR INDUSTRIAL CONTROL EQUIPMENT - Edition 17

### Ratings

| Parameter                     | Symbol    | Unit    | Value                               |
|-------------------------------|-----------|---------|-------------------------------------|
| Primary involved potential    |           | V AC/DC | 600                                 |
| Ambient operating temperature | $T_A$     | °C      | 105                                 |
| Primary current               | $I_P$     | A       | According to series primary current |
| Secondary supply voltage      | $U_C$     | V DC    | 5                                   |
| Output voltage                | $U_{out}$ | V       | 0 to 5                              |

### Conditions of acceptability

- 1 - These devices have been evaluated for overvoltage category III and for use in pollution degree 2 environment.
- 2 - A suitable enclosure shall be provided in the end-use application.
- 3 - The terminals have not been evaluated for field wiring.
- 4 - These devices are intended to be mounted on a printed wiring board of end use equipment. The suitability of the connections (including spacings) shall be determined in the end-use application.
- 5 - Primary terminals shall not be straightened since assembly of housing case depends upon bending of the terminals.
- 6 - Any surface of polymeric housing have not been evaluated as insulating barrier.
- 7 - Low voltage control circuit shall be supplied by an isolating source (such as a transformer, optical isolator, limiting impedance or electro-mechanical relay).

### Marking

Only those products bearing the UR Mark should be considered to be Listed or Recognized and covered under UL's Follow-Up Service. Always look for the Mark on the product.

**Insulation coordination**

| Parameter   | Symbol   | Unit | Value | Comment  |
|---|----------|------|-------|--|
| RMS voltage for AC insulation test, 50 Hz, 1 min    | $U_d$    | kV   | 4.3   |  |
| Impulse withstand voltage 1.2/50 $\mu$ s            | $U_{Ni}$ | kV   | 8     |  |
| Partial discharge RMS test voltage ( $q_m < 10$ pC) | $U_t$    | V    | 1500  | Primary / Secondary  |
| Clearance (pri. - sec.)                             | $d_{Cl}$ | mm   | > 8   | Shortest distance through air  |
| Creepage distance (pri. - sec.)                     | $d_{Cp}$ | mm   | > 8   | Shortest path along device body  |
| Clearance (pri. - sec.)                             |          | mm   | > 8   | When mounted on PCB with recommended layout                                      |
| Case material                                       |          |      | V0    | According to UL 94   |
| Comparative tracking index                          | $CTI$    |      | 600   |  |
| Application example                                 |          | V    | 600   | Reinforced insulation, non uniform field according to IEC 61800-5-1, CAT III PD2 |
| Application example                                 |          | V    | 1000  | Basic insulation non uniform field according to IEC 61800-5-1, CAT III PD2       |
| Application example                                 |          | V    | 600   | Simple insulation, non uniform field according to UL 508, CAT III PD2            |

**Environmental and mechanical characteristics**

| Parameter                     | Symbol           | Unit | Min | Typ | Max | Comment |
|-------------------------------|------------------|------|-----|-----|-----|---------|
| Ambient operating temperature | $T_A$            | °C   | -40 |     | 105 |         |
| Ambient storage temperature   | $T_{A\text{st}}$ | °C   | -40 |     | 105 |         |
| Mass                          | $m$              | g    |     | 31  |     |         |

**Electrical data HO 40-NP-0100**

 At  $T_A = 25^\circ\text{C}$ ,  $U_C = +5\text{V}$ ,  $R_L = 10\text{k}\Omega$  unless otherwise noted (see Min, Max, typ. definition paragraph in page 13).

| Parameter   | Symbol               | Unit                           | Min                  | Typ                  | Max                  | Comment   |
|---|----------------------|--------------------------------|----------------------|----------------------|----------------------|---|
| Primary nominal RMS current   | $I_{PN}$             | A                              |                      | 40                   |                      |   |
| Primary current, measuring range  | $I_{PM}$             | A                              | -100                 |                      | 100                  | @ $U_C \geq 4.6\text{V}$  |
| Number of primary turns   | $N_P$                |                                |                      | 1,2,4                |                      | See application information   |
| Resistance of primary @ +25 °C  | $R_P$                | m $\Omega$                     |                      | 0.09                 |                      | 4 jumpers in parallel   |
| Resistance of primary @ +120 °C   | $R_P$                | m $\Omega$                     |                      | 0.12                 |                      | 4 jumpers in parallel   |
| Supply voltage <sup>1)</sup>  | $U_C$                | V                              | 4.5                  | 5                    | 5.5                  |   |
| Current consumption   | $I_C$                | mA                             |                      | 19                   | 25                   |   |
| Reference voltage (output)  | $U_{ref}$            | V                              | 2.48                 | 2.5                  | 2.52                 | Internal reference  |
| Reference voltage (input)   | $U_{ref}$            | V                              | 0.5                  |                      | 2.65                 | External reference  |
| Output voltage range @ $I_{PM}$   | $U_{out} - U_{ref}$  | V                              | -2                   |                      | 2                    | Over operating temperature range                                    |
| Internal series resistance of reference voltage source                      | $R_{ref}$            | $\Omega$                       | 130                  | 200                  | 300                  | Series  |
| Output internal resistance  | $R_{out}$            | $\Omega$                       |                      | 2                    | 5                    | Series  |
| Load capacitance  | $C_L$                | nF                             | 0                    |                      | 6                    |   |
| OCD output on resistance  | $R_{on\text{OCD}}$   | $\Omega$                       | 70                   | 95                   | 150                  | Open drain, active low<br>Over operating temperature range          |
| OCD output hold time  | $t_{hold\text{OCD}}$ | ms                             | 0.7                  | 1                    | 1.4                  | Additional time after threshold has released                        |
| EEPROM control  | $U_{out}$            | mV                             | 0                    |                      | 50                   | $U_{out}$ forced to GND when EEPROM in an error state <sup>2)</sup> |
| Electrical offset voltage @ $I_P = 0\text{A}$                               | $U_{OE}$             | mV                             | -5                   |                      | 5                    | $U_{out} - U_{ref}$ @ $U_{ref} = 2.5\text{V}$                       |
| Electrical offset current referred to primary                               | $I_{OE}$             | A                              | -0.25                |                      | 0.25                 |   |
| Temperature coefficient of $U_{ref}$  | $TCU_{ref}$          | ppm/K                          | -170                 |                      | 170                  | -40 °C ... 105 °C   |
| Temperature coefficient of $U_{OE}$   | $TCU_{OE}$           | mV/K                           | -0.075               |                      | 0.075                | -40 °C ... 105 °C   |
| Temperature coefficient of $I_{OE}$ referred to primary @ $I_P = 0\text{A}$ | $TCI_{OE}$           | mA/K                           | -3.75                |                      | 3.75                 | -40 °C ... 105 °C   |
| Nominal sensitivity   | $S_N$                | mV/A                           |                      | 20                   |                      | 800 mV @ $I_{PN}$   |
| Sensitivity error @ $I_{PN}$  | $\epsilon_S$         | %                              | -0.75                |                      | 0.75                 | Factory adjustment, 1 turn configuration, 4 jumpers in parallel     |
| Temperature coefficient of S  | $TCS$                | ppm/K                          | -200                 |                      | 200                  | -40 °C ... 105 °C   |
| Linearity error 0 ... $I_{PN}$  | $\epsilon_L$         | % of $I_{PN}$                  | -0.75                |                      | 0.75                 |   |
| Linearity error 0 ... $I_{PM}$  | $\epsilon_L$         | % of $I_{PM}$                  | -0.5                 |                      | 0.5                  |   |
| Magnetic offset current (@ $10 \times I_{PN}$ ) referred to primary         | $I_{OM}$             | A                              | -0.8                 |                      | 0.8                  | One turn  |
| Delay time to 10 % of the final output value for $I_{PN}$ step              | $t_{D10}$            | $\mu\text{s}$                  |                      |                      | 2                    | @ 50 A/ $\mu\text{s}$   |
| Delay time to 90 % of the final output value for $I_{PN}$ step              | $t_{D90}$            | $\mu\text{s}$                  |                      |                      | 2.5                  | @ 50 A/ $\mu\text{s}$   |
| Frequency bandwidth (-3 dB)   | $BW$                 | kHz                            |                      | 350                  |                      |   |
| Noise voltage spectral density 100 Hz ... 100 kHz                           | $u_{no}$             | $\mu\text{V}/\sqrt{\text{Hz}}$ |                      |                      | 16                   |   |
| RMS noise voltage (DC ... 10 kHz)<br>(DC ... 100 kHz)<br>(DC ... 1 MHz)     | $U_{no}$             | mVpp                           |                      | 8<br>25<br>46.2      |                      |   |
| Primary current, detection threshold  | $I_{PTh}$            | A                              | $2.64 \times I_{PN}$ | $2.93 \times I_{PN}$ | $3.22 \times I_{PN}$ | Peak value $\pm 10\%$ , overcurrent detection OCD                   |
| Sum of sensitivity and linearity error @ $I_{PN}$                           | $\epsilon_{SL}$      | % of $I_{PN}$                  | -1.5                 |                      | 1.5                  |   |
| Sum of sensitivity and linearity error at 105° C @ $I_{PN}$                 | $\epsilon_{SL105}$   | % of $I_{PN}$                  | -3.85                |                      | 3.85                 | See formula <sup>3)</sup>   |
| Sum of sensitivity and linearity error at 85° C @ $I_{PN}$                  | $\epsilon_{SL85}$    | % of $I_{PN}$                  | -3.26                |                      | 3.26                 | See formula <sup>3)</sup>   |

**Notes:** <sup>1)</sup> 3.3 V SP version available

<sup>2)</sup> EEPROM in an error state makes the transducer behave like a reverse current saturation. Use of the OCD may help to differentiate the two cases.

<sup>3)</sup> Sum of sensitivity and linearity error @  $T_A$  (% of  $I_{PN}$ ) =  $\epsilon_{SL} + (\frac{TCS}{10000} \times (T_A - 25) + \frac{TCI_{OE}}{10000 \times I_{PN}} \times 100 \times (T_A - 25))$ 

Page 5/15

**Electrical data HO 60-NP-0100**

 At  $T_A = 25^\circ\text{C}$ ,  $U_C = +5\text{V}$ ,  $R_L = 10\text{k}\Omega$  unless otherwise noted (see Min, Max, typ. definition paragraph in page 13).

| Parameter   | Symbol              | Unit                           | Min                  | Typ                  | Max                  | Comment   |
|---|---------------------|--------------------------------|----------------------|----------------------|----------------------|---|
| Primary nominal RMS current   | $I_{PN}$            | A                              |                      | 60                   |                      |   |
| Primary current, measuring range  | $I_{PM}$            | A                              | -150                 |                      | 150                  | @ $U_C \geq 4.6\text{V}$  |
| Number of primary turns   | $N_P$               |                                |                      | 1,2,4                |                      | See application information   |
| Resistance of primary @ +25 °C  | $R_P$               | m $\Omega$                     |                      | 0.09                 |                      | 4 jumpers in parallel   |
| Resistance of primary @ +120 °C   | $R_P$               | m $\Omega$                     |                      | 0.12                 |                      | 4 jumpers in parallel   |
| Supply voltage <sup>1)</sup>  | $U_C$               | V                              | 4.5                  | 5                    | 5.5                  |   |
| Current consumption   | $I_C$               | mA                             |                      | 19                   | 25                   |   |
| Reference voltage (output)  | $U_{ref}$           | V                              | 2.48                 | 2.5                  | 2.52                 | Internal reference  |
| Reference voltage (input)   | $U_{ref}$           | V                              | 0.5                  |                      | 2.65                 | External reference  |
| Output voltage range @ $I_{PM}$   | $U_{out} - U_{ref}$ | V                              | -2                   |                      | 2                    | Over operating temperature range                                    |
| Internal series resistance of reference voltage source                      | $R_{ref}$           | $\Omega$                       | 130                  | 200                  | 300                  | Series  |
| Output internal resistance  | $R_{out}$           | $\Omega$                       |                      | 2                    | 5                    | Series  |
| Load capacitance  | $C_L$               | nF                             | 0                    |                      | 6                    |   |
| OCD output on resistance  | $R_{onOCD}$         | $\Omega$                       | 70                   | 95                   | 150                  | Open drain, active low, Over operating temperature range            |
| OCD output hold time  | $t_{holdOCD}$       | ms                             | 0.7                  | 1                    | 1.4                  | Additional time after threshold has released                        |
| EEPROM control  | $U_{out}$           | mV                             | 0                    |                      | 50                   | $U_{out}$ forced to GND when EEPROM in an error state <sup>2)</sup> |
| Electrical offset voltage @ $I_P = 0\text{A}$                               | $U_{OE}$            | mV                             | -5                   |                      | 5                    | $U_{out} - U_{ref}$ @ $U_{ref} = 2.5\text{V}$                       |
| Electrical offset current referred to primary                               | $I_{OE}$            | A                              | -0.375               |                      | 0.375                |   |
| Temperature coefficient of $U_{ref}$  | $TCU_{ref}$         | ppm/K                          | -170                 |                      | 170                  | -40 °C ... 105 °C   |
| Temperature coefficient of $U_{OE}$   | $TCU_{OE}$          | mV/K                           | -0.075               |                      | 0.075                | -40 °C ... 105 °C   |
| Temperature coefficient of $I_{OE}$ referred to primary @ $I_P = 0\text{A}$ | $TCI_{OE}$          | mA/K                           | -5.625               |                      | 5.625                | -40 °C ... 105 °C   |
| Nominal sensitivity   | $S_N$               | mV/A                           |                      | 13.333               |                      | 800 mV @ $I_{PN}$   |
| Sensitivity error @ $I_{PN}$  | $\epsilon_S$        | %                              | -0.75                |                      | 0.75                 | Factory adjustment, 1 turn configuration, 4 jumpers in parallel     |
| Temperature coefficient of $S$  | $TCS$               | ppm/K                          | -200                 |                      | 200                  | -40 °C ... 105 °C   |
| Linearity error 0 ... $I_{PN}$  | $\epsilon_L$        | % of $I_{PN}$                  | -0.65                |                      | 0.65                 |   |
| Linearity error 0 ... $I_{PM}$  | $\epsilon_L$        | % of $I_{PM}$                  | -0.5                 |                      | 0.5                  |   |
| Magnetic offset current (@ $10 \times I_{PN}$ ) referred to primary         | $I_{OM}$            | A                              | -0.8                 |                      | 0.8                  | One turn  |
| Delay time to 10 % of the final output value for $I_{PN}$ step              | $t_{D10}$           | $\mu\text{s}$                  |                      |                      | 2                    | @ 50 A/ $\mu\text{s}$   |
| Delay time to 90 % of the final output value for $I_{PN}$ step              | $t_{D90}$           | $\mu\text{s}$                  |                      |                      | 2.5                  | @ 50 A/ $\mu\text{s}$   |
| Frequency bandwidth (-3 dB)   | $BW$                | kHz                            |                      | 350                  |                      |   |
| Noise voltage spectral density 100 Hz ... 100 kHz                           | $u_{no}$            | $\mu\text{V}/\sqrt{\text{Hz}}$ |                      |                      | 11                   |   |
| RMS noise voltage (DC ... 10 kHz)<br>(DC ... 100 kHz)<br>(DC ... 1 MHz)     | $U_{no}$            | mVpp                           |                      | 5.7<br>16.5<br>31.1  |                      |   |
| Primary current, detection threshold  | $I_{PTh}$           | A                              | $2.64 \times I_{PN}$ | $2.93 \times I_{PN}$ | $3.22 \times I_{PN}$ | Peak value $\pm 10\%$ , overcurrent detection OCD                   |
| Sum of sensitivity and linearity error @ $I_{PN}$                           | $\epsilon_{SL}$     | % of $I_{PN}$                  | -1.4                 |                      | 1.4                  |   |
| Sum of sensitivity and linearity error at 105° C @ $I_{PN}$                 | $\epsilon_{SL105}$  | % of $I_{PN}$                  | -3.75                |                      | 3.75                 | See formula <sup>3)</sup>   |
| Sum of sensitivity and linearity error at 85° C @ $I_{PN}$                  | $\epsilon_{SL85}$   | % of $I_{PN}$                  | -3.16                |                      | 3.16                 | See formula <sup>3)</sup>   |

**Notes:** <sup>1)</sup> 3.3 V SP version available

<sup>2)</sup> EEPROM in an error state makes the transducer behave like a reverse current saturation. Use of the OCD may help to differentiate the two cases.

<sup>3)</sup> Sum of sensitivity and linearity error @  $T_A$  (% of  $I_{PN}$ ) =  $\epsilon_{SL} + \left( \frac{TCS}{10000} \times (T_A - 25) + \frac{TCI_{OE}}{10000 \times I_{PN}} \times 100 \times (T_A - 25) \right)$

**Electrical data HO 120-NP-0100**

 At  $T_A = 25\text{ °C}$ ,  $U_C = +5\text{ V}$ ,  $R_L = 10\text{ k}\Omega$  unless otherwise noted (see Min, Max, typ. definition paragraph in page 13).

| Parameter  | Symbol               | Unit                           | Min                  | Typ                  | Max                  | Comment   |
|--|----------------------|--------------------------------|----------------------|----------------------|----------------------|---|
| Primary nominal RMS current  | $I_{PN}$             | A                              |                      | 120                  |                      |   |
| Primary current, measuring range   | $I_{PM}$             | A                              | -300                 |                      | 300                  | @ $U_C \geq 4.6\text{ V}$   |
| Number of primary turns  | $N_P$                |                                |                      | 1,2,4                |                      | See application information   |
| Resistance of primary @ +25 °C   | $R_P$                | m $\Omega$                     |                      | 0.09                 |                      | 4 jumpers in parallel   |
| Resistance of primary @ +120 °C  | $R_P$                | m $\Omega$                     |                      | 0.12                 |                      | 4 jumpers in parallel   |
| Supply voltage <sup>1)</sup>   | $U_C$                | V                              | 4.5                  | 5                    | 5.5                  |   |
| Current consumption  | $I_C$                | mA                             |                      | 19                   | 25                   |   |
| Reference voltage (output)   | $U_{ref}$            | V                              | 2.48                 | 2.5                  | 2.52                 | Internal reference  |
| Reference voltage (input)  | $U_{ref}$            | V                              | 0.5                  |                      | 2.65                 | External reference  |
| Output voltage range @ $I_{PM}$  | $U_{out} - U_{ref}$  | V                              | -2                   |                      | 2                    | Over operating temperature range                                    |
| Internal series resistance of reference voltage                              | $R_{ref}$            | $\Omega$                       | 130                  | 200                  | 300                  | Series  |
| Output internal resistance   | $R_{out}$            | $\Omega$                       |                      | 2                    | 5                    | Series  |
| Load capacitance   | $C_L$                | nF                             | 0                    |                      | 6                    |   |
| OCD output on resistance   | $R_{on\text{OCD}}$   | $\Omega$                       | 70                   | 95                   | 150                  | Open drain, active low, Over operating temperature range            |
| OCD output hold time   | $t_{hold\text{OCD}}$ | ms                             | 0.7                  | 1                    | 1.4                  | Additional time after threshold has released                        |
| EEPROM control   | $U_{out}$            | mV                             | 0                    |                      | 50                   | $U_{out}$ forced to GND when EEPROM in an error state <sup>2)</sup> |
| Electrical offset voltage @ $I_P = 0\text{ A}$                               | $U_{OE}$             | mV                             | -5                   |                      | 5                    | $U_{out} - U_{ref}$ @ $U_{ref} = 2.5\text{ V}$                      |
| Electrical offset current Referred to primary                                | $I_{OE}$             | A                              | -0.75                |                      | 0.75                 |   |
| Temperature coefficient of $U_{ref}$   | $TCU_{ref}$          | ppm/K                          | -170                 |                      | 170                  | -40 °C ... 105 °C   |
| Temperature coefficient of $U_{OE}$  | $TCU_{OE}$           | mV/K                           | -0.075               |                      | 0.075                | -40 °C ... 105 °C   |
| Temperature coefficient of $I_{OE}$ referred to primary @ $I_P = 0\text{ A}$ | $TCI_{OE}$           | mA/K                           | -11.25               |                      | 11.25                | -40 °C ... 105 °C   |
| Nominal sensitivity  | $S_N$                | mV/A                           |                      | 6.667                |                      | 800 mV @ $I_{PN}$   |
| Sensitivity error @ $I_{PN}$   | $\varepsilon_S$      | %                              | -0.75                |                      | 0.75                 | Factory adjustment, 1 turn configuration, 4 jumpers in parallel     |
| Temperature coefficient of $S$   | $TCS$                | ppm/K                          | -200                 |                      | 200                  | -40 °C ... 105 °C   |
| Linearity error 0 ... $I_{PN}$   | $\varepsilon_L$      | % of $I_{PN}$                  | -0.5                 |                      | 0.5                  |   |
| Linearity error 0 ... $I_{PM}$   | $\varepsilon_L$      | % of $I_{PM}$                  | -0.5                 |                      | 0.5                  |   |
| Magnetic offset current (@ $10 \times I_{PN}$ ) referred to primary          | $I_{OM}$             | A                              | -0.8                 |                      | 0.8                  | One turn  |
| Delay time to 10 % of $I_{PN}$   | $t_{D10}$            | $\mu\text{s}$                  |                      |                      | 2                    | @ 50 A/ $\mu\text{s}$   |
| Delay time to 90 % of $I_{PN}$   | $t_{D90}$            | $\mu\text{s}$                  |                      |                      | 2.5                  | @ 50 A/ $\mu\text{s}$   |
| Frequency bandwidth (-3 dB)  | $BW$                 | kHz                            |                      | 350                  |                      |   |
| Noise voltage spectral density 100 Hz ... 100 kHz                            | $u_{no}$             | $\mu\text{V}/\sqrt{\text{Hz}}$ |                      |                      | 6.1                  |   |
| RMS noise voltage (DC ... 10 kHz)<br>(DC ... 100 kHz)<br>(DC ... 1 MHz)      | $U_{no}$             | mVpp                           |                      | 3.6<br>8.9<br>17.1   |                      |   |
| Primary current, detection threshold   | $I_{PTh}$            | A                              | $2.64 \times I_{PN}$ | $2.93 \times I_{PN}$ | $3.22 \times I_{PN}$ | Peak value $\pm 10\%$ , overcurrent detection OCD                   |
| Sum of sensitivity and linearity @ $I_{PN}$                                  | $\varepsilon_{SL}$   | % of $I_{PN}$                  | -1.25                |                      | 1.25                 |   |
| Sum of sensitivity and linearity @ $I_{PN}$ @ $T_A = +105\text{ °C}$         | $\varepsilon_{SL}$   | % of $I_{PN}$                  | -3.60                |                      | 3.60                 | See formula <sup>3)</sup>   |
| Sum of sensitivity and linearity @ $I_{PN}$ @ $T_A = +85\text{ °C}$          | $\varepsilon_{SL}$   | % of $I_{PN}$                  | -3.01                |                      | 3.01                 | See formula <sup>3)</sup>   |

**Notes:** <sup>1)</sup> 3.3 V SP version available

<sup>2)</sup> EEPROM in an error state makes the transducer behave like a reverse current saturation. Use of the OCD may help to differentiate the two cases.

<sup>3)</sup> Sum of sensitivity and linearity error @  $T_A$  (% of  $I_{PN}$ ) =  $\varepsilon_{SL} + \left( \frac{TCS}{10000} \times (T_A - 25) + \frac{TCI_{OE}}{10000 \times I_{PN}} \times 100 \times (T_A - 25) \right)$

**Electrical data HO 128-NP-0100**

 At  $T_A = 25\text{ °C}$ ,  $U_C = +5\text{ V}$ ,  $R_L = 10\text{ k}\Omega$  unless otherwise noted (see Min, Max, typ. definition paragraph in page 13).

| Parameter  | Symbol               | Unit                           | Min                  | Typ                  | Max                  | Comment   |
|--|----------------------|--------------------------------|----------------------|----------------------|----------------------|---|
| Primary nominal RMS current  | $I_{PN}$             | A                              |                      | 128                  |                      |   |
| Primary current, measuring range   | $I_{PM}$             | A                              | -320                 |                      | 320                  | @ $U_C \geq 4.6\text{ V}$   |
| Number of primary turns  | $N_p$                |                                |                      | 1,2,4                |                      | See application information   |
| Resistance of primary @ +25 °C   | $R_p$                | m $\Omega$                     |                      | 0.09                 |                      | 4 jumpers in parallel   |
| Resistance of primary @ +120 °C  | $R_p$                | m $\Omega$                     |                      | 0.12                 |                      | 4 jumpers in parallel   |
| Supply voltage <sup>1)</sup>   | $U_C$                | V                              | 4.5                  | 5                    | 5.5                  |   |
| Current consumption  | $I_C$                | mA                             |                      | 19                   | 25                   |   |
| Reference voltage (output)   | $U_{ref}$            | V                              | 2.48                 | 2.5                  | 2.52                 | Internal reference  |
| Reference voltage (input)  | $U_{ref}$            | V                              | 0.5                  |                      | 2.65                 | External reference  |
| Output voltage range @ $I_{PM}$  | $U_{out} - U_{ref}$  | V                              | -2                   |                      | 2                    | Over operating temperature range                                    |
| Internal series resistance of reference voltage                              | $R_{ref}$            | $\Omega$                       | 130                  | 200                  | 300                  | Series  |
| Output internal resistance   | $R_{out}$            | $\Omega$                       |                      | 2                    | 5                    | Series  |
| Load capacitance   | $C_L$                | nF                             | 0                    |                      | 6                    |   |
| OCD output on resistance   | $R_{on\text{OCD}}$   | $\Omega$                       | 70                   | 95                   | 150                  | Open drain, active low,<br>Over operating temperature range         |
| OCD output hold time   | $t_{hold\text{OCD}}$ | ms                             | 0.7                  | 1                    | 1.4                  | Additional time after threshold has released                        |
| EEPROM control   | $U_{out}$            | mV                             | 0                    |                      | 50                   | $U_{out}$ forced to GND when EEPROM in an error state <sup>2)</sup> |
| Electrical offset voltage @ $I_p = 0\text{ A}$                               | $U_{OE}$             | mV                             | -5                   |                      | 5                    | $U_{out} - U_{ref}$ @ $U_{ref} = 2.5\text{ V}$                      |
| Electrical offset current Referred to primary                                | $I_{OE}$             | A                              | -0.8                 |                      | 0.8                  |   |
| Temperature coefficient of $U_{ref}$   | $TCU_{ref}$          | ppm/K                          | -170                 |                      | 170                  | -40 °C ... 105 °C   |
| Temperature coefficient of $U_{OE}$  | $TCU_{OE}$           | mV/K                           | -0.075               |                      | 0.075                | -40 °C ... 105 °C   |
| Temperature coefficient of $I_{OE}$ referred to primary @ $I_p = 0\text{ A}$ | $TCI_{OE}$           | mA/K                           | -12                  |                      | 12                   | -40 °C ... 105 °C   |
| Nominal sensitivity  | $S_N$                | mV/A                           |                      | 6.25                 |                      | 800 mV @ $I_{PN}$   |
| Sensitivity error @ $I_{PN}$   | $\varepsilon_S$      | %                              | -0.75                |                      | 0.75                 | Factory adjustment, 1 turn configuration, 4 jumpers in parallel     |
| Temperature coefficient of $S$   | $TCS$                | ppm/K                          | -200                 |                      | 200                  | -40 °C ... 105 °C   |
| Linearity error 0 ... $I_{PN}$   | $\varepsilon_L$      | % of $I_{PN}$                  | -0.5                 |                      | 0.5                  |   |
| Linearity error 0 ... $I_{PM}$   | $\varepsilon_L$      | % of $I_{PM}$                  | -0.5                 |                      | 0.5                  |   |
| Magnetic offset current (@ $10 \times I_{PN}$ ) referred to primary          | $I_{OM}$             | A                              | -0.8                 |                      | 0.8                  | One turn  |
| Delay time to 10 % of $I_{PN}$   | $t_{D10}$            | $\mu\text{s}$                  |                      |                      | 2                    | @ 50 A/ $\mu\text{s}$   |
| Delay time to 90 % of $I_{PN}$   | $t_{D90}$            | $\mu\text{s}$                  |                      |                      | 2.5                  | @ 50 A/ $\mu\text{s}$   |
| Frequency bandwidth (-3 dB)  | $BW$                 | kHz                            |                      | 350                  |                      |   |
| Noise voltage spectral density 100 Hz ... 100 kHz                            | $u_{no}$             | $\mu\text{V}/\sqrt{\text{Hz}}$ |                      |                      | 5.7                  |   |
| RMS noise voltage (DC ... 10 kHz)<br>(DC ... 100 kHz)<br>(DC ... 1 MHz)      | $U_{no}$             | mVpp                           |                      | 3.5<br>8.4<br>16.5   |                      |   |
| Primary current, detection threshold   | $I_{PTh}$            | A                              | $2.64 \times I_{PN}$ | $2.93 \times I_{PN}$ | $3.22 \times I_{PN}$ | Peak value $\pm 10\%$ , overcurrent detection OCD                   |
| Sum of sensitivity and linearity @ $I_{PN}$                                  | $\varepsilon_{SL}$   | % of $I_{PN}$                  | -1.25                |                      | 1.25                 |   |
| Sum of sensitivity and linearity @ $I_{PN}$ @ $T_A = +105\text{ °C}$         | $\varepsilon_{SL}$   | % of $I_{PN}$                  | -3.60                |                      | 3.60                 | See formula <sup>3)</sup>   |
| Sum of sensitivity and linearity @ $I_{PN}$ @ $T_A = +85\text{ °C}$          | $\varepsilon_{SL}$   | % of $I_{PN}$                  | -3.01                |                      | 3.01                 | See formula <sup>3)</sup>   |

**Notes:** <sup>1)</sup> 3.3 V SP version available

<sup>2)</sup> EEPROM in an error state makes the transducer behave like a reverse current saturation. Use of the OCD may help to differentiate the two cases.

<sup>3)</sup> Sum of sensitivity and linearity error @  $T_A$  (% of  $I_{PN}$ ) =  $\varepsilon_{SL} + (-\frac{TCS}{10000} \times (T_A - 25) + \frac{TCI_{OE}}{10000 \times I_{PN}} \times 100 \times (T_A - 25))$



**Electrical data HO 150-NP-0100**

 At  $T_A = 25^\circ\text{C}$ ,  $U_C = +5\text{ V}$ ,  $R_L = 10\text{ k}\Omega$  unless otherwise noted (see Min, Max, typ. definition paragraph in page 13).

| Parameter   | Symbol               | Unit                           | Min                  | Typ                  | Max                  | Comment   |
|---|----------------------|--------------------------------|----------------------|----------------------|----------------------|---|
| Primary nominal RMS current   | $I_{PN}$             | A                              |                      | 150                  |                      |   |
| Primary current, measuring range $85^\circ\text{C}^{1)}$<br>$105^\circ\text{C}$ | $I_{PM}$             | A                              | -375<br>-360         |                      | 375<br>360           | @ $U_C \geq 4.6\text{ V}$   |
| Number of primary turns   | $N_p$                |                                |                      | 1,2,4                |                      | See application information   |
| Resistance of primary @ $+25^\circ\text{C}$                                     | $R_p$                | m $\Omega$                     |                      | 0.09                 |                      | 4 jumpers in parallel   |
| Resistance of primary @ $+120^\circ\text{C}$                                    | $R_p$                | m $\Omega$                     |                      | 0.12                 |                      | 4 jumpers in parallel   |
| Supply voltage <sup>2)</sup>  | $U_C$                | V                              | 4.5                  | 5                    | 5.5                  |   |
| Current consumption   | $I_C$                | mA                             |                      | 19                   | 25                   |   |
| Reference voltage (output)  | $U_{ref}$            | V                              | 2.48                 | 2.5                  | 2.52                 | Internal reference  |
| Reference voltage (input)   | $U_{ref}$            | V                              | 0.5                  |                      | 2.65                 | External reference  |
| Output voltage range @ $I_{PM}$   | $U_{out} - U_{ref}$  | V                              | -2                   |                      | 2                    | Over operating temperature range                                    |
| Internal series resistance of reference voltage                                 | $R_{ref}$            | $\Omega$                       | 130                  | 200                  | 300                  | Series  |
| Output internal resistance  | $R_{out}$            | $\Omega$                       |                      | 2                    | 5                    | Series  |
| Load capacitance  | $C_L$                | nF                             | 0                    |                      | 6                    |   |
| OCD output on resistance  | $R_{on\text{OCD}}$   | $\Omega$                       | 70                   | 95                   | 150                  | Open drain, active low,<br>Over operating temperature range         |
| OCD output hold time  | $t_{hold\text{OCD}}$ | ms                             | 0.7                  | 1                    | 1.4                  | Additional time after threshold has released                        |
| EEPROM control  | $U_{out}$            | mV                             | 0                    |                      | 50                   | $U_{out}$ forced to GND when EEPROM in an error state <sup>3)</sup> |
| Electrical offset voltage @ $I_p = 0\text{ A}$                                  | $U_{OE}$             | mV                             | -5                   |                      | 5                    | $U_{out} - U_{ref}$ @ $U_{ref} = 2.5\text{ V}$                      |
| Electrical offset current<br>Referred to primary                                | $I_{OE}$             | A                              | -0.9375              |                      | 0.9375               |   |
| Temperature coefficient of $U_{ref}$  | $TCU_{ref}$          | ppm/K                          | -170                 |                      | 170                  | $-40^\circ\text{C} \dots 105^\circ\text{C}$                         |
| Temperature coefficient of $U_{OE}$   | $TCU_{OE}$           | mV/K                           | -0.075               |                      | 0.075                | $-40^\circ\text{C} \dots 105^\circ\text{C}$                         |
| Temperature coefficient of $I_{OE}$ referred to primary @ $I_p = 0\text{ A}$    | $TCI_{OE}$           | mA/K                           | -14.0625             |                      | 14.0625              | $-40^\circ\text{C} \dots 105^\circ\text{C}$                         |
| Nominal sensitivity   | $S_N$                | mV/A                           |                      | 5.333                |                      | 800 mV @ $I_{PN}$   |
| Sensitivity error @ $I_{PN}$  | $\epsilon_S$         | %                              | -0.75                |                      | 0.75                 | Factory adjustment, 1 turn configuration, 4 jumpers in parallel     |
| Temperature coefficient of $S$  | $TCS$                | ppm/K                          | -200                 |                      | 200                  | $-40^\circ\text{C} \dots 105^\circ\text{C}$                         |
| Linearity error 0 ... $I_{PN}$  | $\epsilon_L$         | % of $I_{PN}$                  | -0.4                 |                      | 0.4                  |   |
| Linearity error 0 ... $I_{PM}$  | $\epsilon_L$         | % of $I_{PM}$                  | -0.5                 |                      | 0.5                  |   |
| Magnetic offset current (@ $10 \times I_{PN}$ )<br>referred to primary          | $I_{OM}$             | A                              | -0.8                 |                      | 0.8                  | One turn  |
| Delay time to 10 % of $I_{PN}$  | $t_{D10}$            | $\mu\text{s}$                  |                      |                      | 2                    | @ 50 A/ $\mu\text{s}$   |
| Delay time to 90 % of $I_{PN}$  | $t_{D90}$            | $\mu\text{s}$                  |                      |                      | 2.5                  | @ 50 A/ $\mu\text{s}$   |
| Frequency bandwidth (-3 dB)   | $BW$                 | kHz                            |                      | 350                  |                      |   |
| Noise voltage spectral density<br>100 Hz ... 100 kHz                            | $u_{no}$             | $\mu\text{V}/\sqrt{\text{Hz}}$ |                      |                      | 5.2                  |   |
| RMS noise voltage<br>(DC ... 10 kHz)<br>(DC ... 100 kHz)<br>(DC ... 1 MHz)      | $U_{no}$             | mVpp                           |                      | 3.2<br>7<br>15.3     |                      |   |
| Primary current, detection threshold  | $I_{PTh}$            | A                              | $2.64 \times I_{PN}$ | $2.93 \times I_{PN}$ | $3.22 \times I_{PN}$ | Peak value $\pm 10\%$ , overcurrent detection OCD                   |
| Sum of sensitivity and linearity @ $I_{PN}$                                     | $\epsilon_{SL}$      | % of $I_{PN}$                  | -1.15                |                      | 1.15                 |   |
| Sum of sensitivity and linearity<br>@ $I_{PN}$ @ $T_A = +105^\circ\text{C}$     | $\epsilon_{SL}$      | % of $I_{PN}$                  | -3.50                |                      | 3.50                 | See formula <sup>4)</sup>   |
| Sum of sensitivity and linearity<br>@ $I_{PN}$ @ $T_A = +85^\circ\text{C}$      | $\epsilon_{SL}$      | % of $I_{PN}$                  | -2.91                |                      | 2.91                 | See formula <sup>4)</sup>   |

**Notes:** <sup>1)</sup> Magnetic core temperature remaining equal or less than ambient temperature  $T_A$ 
<sup>2)</sup> 3.3 V SP version available

<sup>3)</sup> EEPROM in an error state makes the transducer behave like a reverse current saturation. Use of the OCD may help to differentiate the two cases

<sup>4)</sup> Sum of sensitivity and linearity error @  $T_A$  (% of  $I_{PN}$ ) =  $\epsilon_{SL} + \left( \frac{TCS}{10000} \times (T_A - 25) \right) + \frac{TCI_{OE}}{10000 \times I_{PN}} \times 100 \times (T_A - 25)$

HO-NP series, measuring range versus external reference voltage

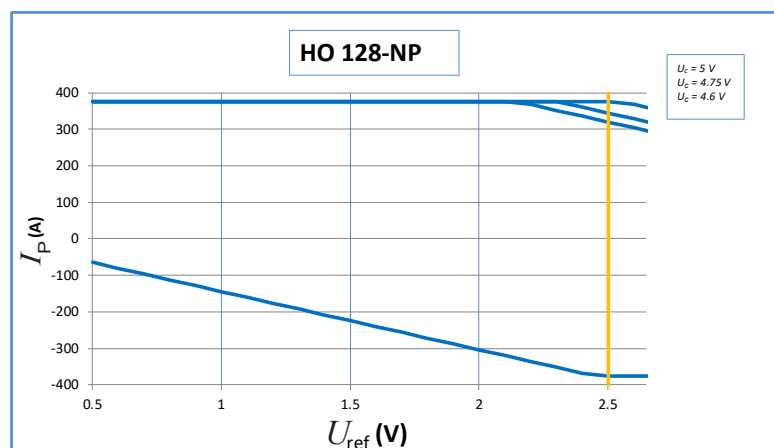
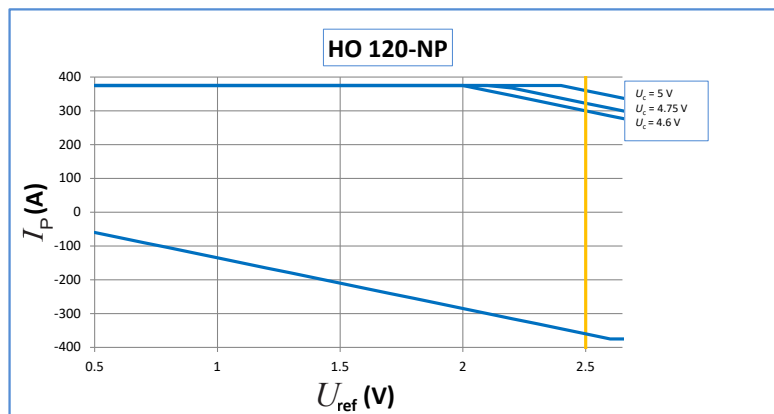
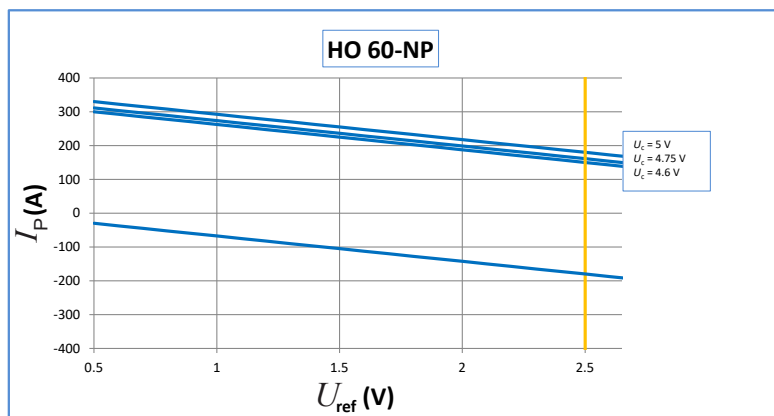
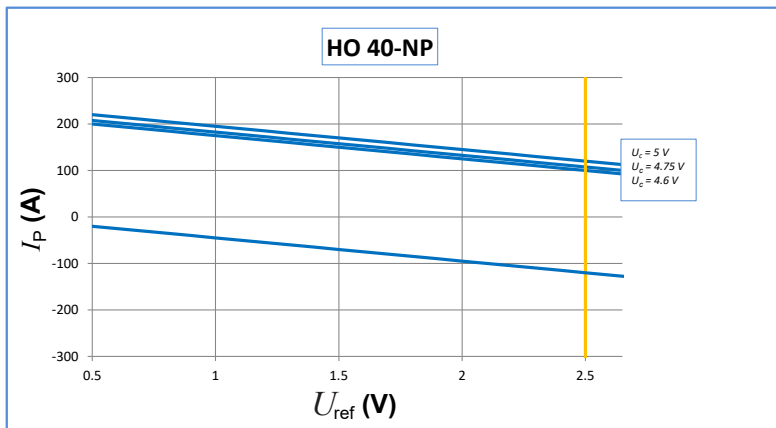

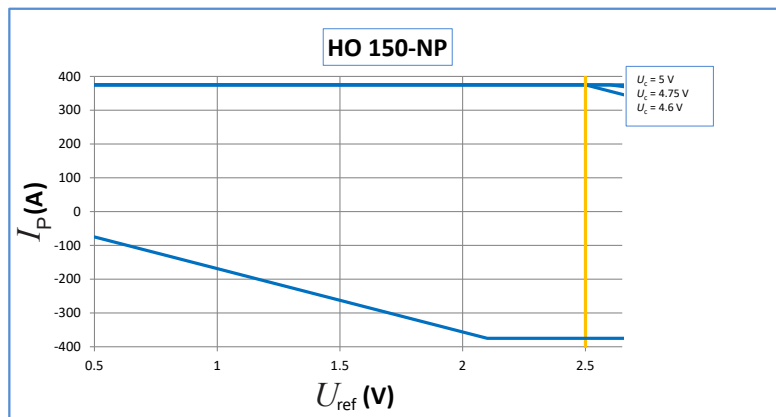

**Maximum continuous DC current**

For all ranges:

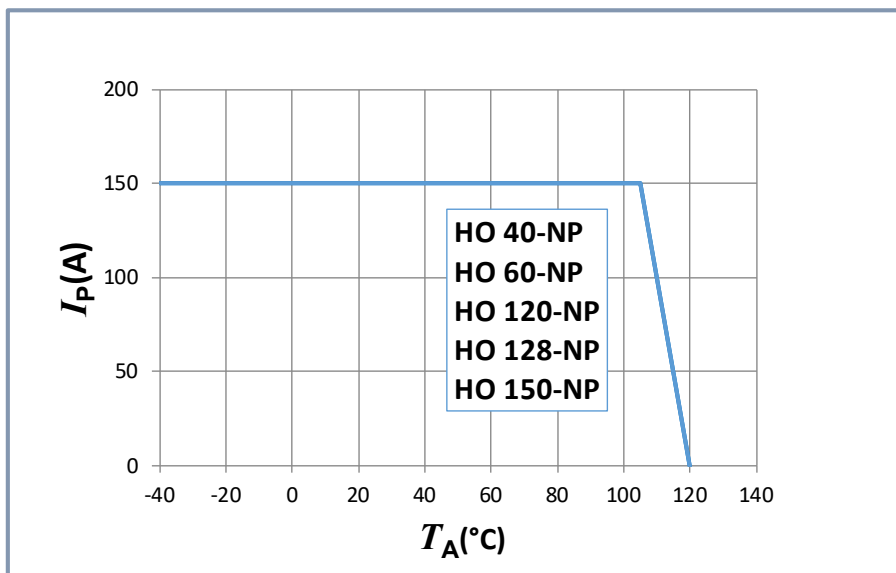

Important Notice: Whatever the usage and/or application, the transducer jumper temperature shall not go above the maximum rating of 120 °C as stated in page 3 of this datasheet.

**HO-NP series: name and codification**

HO family products may be ordered **on request** <sup>1)</sup> with a dedicated setting of the parameters as described below (standard products are delivered with the setting 0100 according to the table).

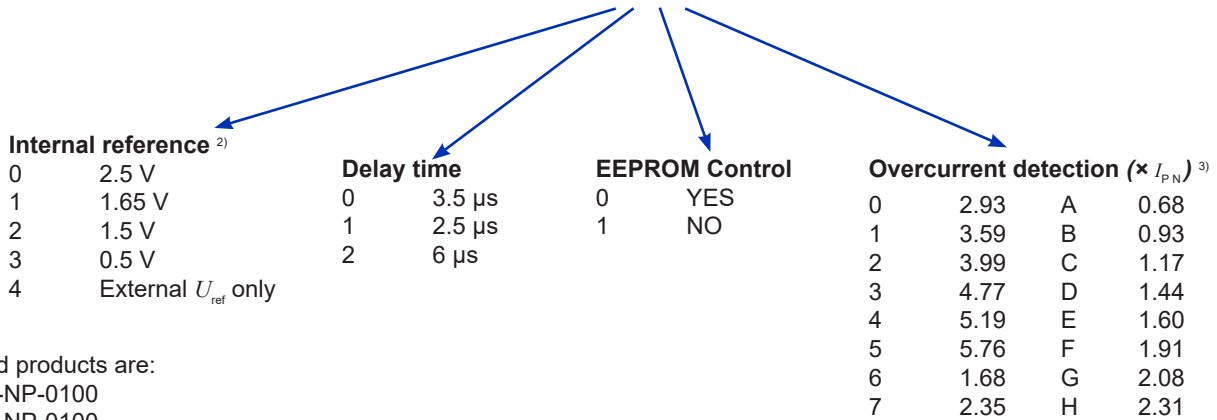
**HO-NP-XXXX**

Standard products are:

- HO 40-NP-0100
- HO 60-NP-0100
- HO 120-NP-0100
- HO 128-NP-0100
- HO 150-NP-0100

**Notes:** <sup>1)</sup> For dedicated settings, minimum quantities apply, please contact your local LEM support.

<sup>2)</sup>  $U_{ref}$  electrical data

| $U_{ref}$ parameter | $U_{ref}$ (V) |      |      | $TCU_{ref}$ (ppm/K) |     |
|---------------------|---------------|------|------|---------------------|-----|
|                     | min           | typ  | max  | min                 | max |
| 0                   | 2.48          | 2.5  | 2.52 | -170                | 170 |
| 1                   | 1.63          | 1.65 | 1.67 | -170                | 170 |
| 2                   | 1.48          | 1.5  | 1.52 | -170                | 170 |
| 3                   | 0.49          | 0.5  | 0.51 | -250                | 250 |

<sup>3)</sup> OCD ( $\times I_{PN}$ ) correction table versus range and temperature

All other values or empty cells: no change

| HO-NP-010x    |                      |    |      |      |
|---------------|----------------------|----|------|------|
| OCD Parameter | $I_{PN}$ (A) @ 25 °C |    |      |      |
|               | 40                   | 60 | 120  | 150  |
| A             |                      |    |      |      |
| B             |                      |    |      |      |
| C             |                      |    |      |      |
| D             |                      |    |      |      |
| E             |                      |    |      |      |
| 6             |                      |    |      |      |
| F             |                      |    |      |      |
| G             |                      |    |      |      |
| H             |                      |    |      |      |
| 7             |                      |    |      |      |
| 0             |                      |    |      |      |
| 1             |                      |    |      | 4.19 |
| 2             |                      |    |      | 6.17 |
| 3             |                      |    |      | 6.17 |
| 4             |                      |    | 5.71 | -    |
| 5             |                      |    | 7.16 | -    |

| HO-NP-010x    |                      |    |      |      |
|---------------|----------------------|----|------|------|
| OCD Parameter | $I_{PN}$ (A) @ 85 °C |    |      |      |
|               | 40                   | 60 | 120  | 150  |
| A             |                      |    |      |      |
| B             |                      |    |      |      |
| C             |                      |    |      |      |
| D             |                      |    |      |      |
| E             |                      |    |      |      |
| 6             |                      |    |      |      |
| F             |                      |    |      |      |
| G             |                      |    |      |      |
| H             |                      |    |      |      |
| 7             |                      |    |      |      |
| 0             |                      |    |      |      |
| 1             |                      |    |      | 4.05 |
| 2             |                      |    | 4.01 | 5.00 |
| 3             |                      |    | 5.72 | -    |
| 4             |                      |    | 6.77 | -    |
| 5             |                      |    | -    | -    |

| HO-NP-010x    |                       |    |      |      |
|---------------|-----------------------|----|------|------|
| OCD Parameter | $I_{PN}$ (A) @ 105 °C |    |      |      |
|               | 40                    | 60 | 120  | 150  |
| A             |                       |    |      |      |
| B             |                       |    |      |      |
| C             |                       |    |      |      |
| D             |                       |    |      |      |
| E             |                       |    |      |      |
| 6             |                       |    |      |      |
| F             |                       |    |      |      |
| G             |                       |    |      |      |
| H             |                       |    |      |      |
| 7             |                       |    |      |      |
| 0             |                       |    |      | 2.98 |
| 1             |                       |    |      | 4.39 |
| 2             |                       |    | 4.38 | 5.38 |
| 3             |                       |    | 6.17 | -    |
| 4             |                       |    | 7.26 | -    |
| 5             |                       |    | -    | -    |

| Tolerance on OCD value |            |
|------------------------|------------|
| ±20 %                  |            |
| ±15 %                  |            |
| ±10 %                  | No change  |
| -                      | Do not use |

**HO-NP series: output compatibility with HAIS Series**

| Reference | $I_{PN}$ (A) | $I_{PM}$ (A) | $\frac{I_{PM}}{I_{PN}}$ | $\frac{U_{out} - U_{ref}}{I_{PN}}$ (V) | Reference   | $I_{PN}$ (A) | $I_{PM}$ (A) | $\frac{I_{PM}}{I_{PN}}$ | $\frac{U_{out} - U_{ref}}{I_{PN}}$ (V) |
|-----------|--------------|--------------|-------------------------|--|-------------|--------------|--------------|-------------------------|--|
| HO 40-NP  | 40           | 100          | 2.5                     | 0.8                                    |             |              |              |                         |  |
| HO 60-NP  | 60           | 150          | 2.5                     | 0.8                                    | HAIS 50-TP  | 50           | 150          | 3                       | 0.625                                  |
| HO 120-NP | 120          | 300          | 2.5                     | 0.8                                    |             |              |              |                         |  |
| HO 128-NP | 128          | 320          | 2.5                     | 0.8                                    | HAIS 100-TP | 100          | 300          | 3                       | 0.625                                  |
| HO 150-NP | 150          | 375          | 2.5                     | 0.8                                    |             |              |              |                         |  |

The HO-NP gives the same output levels as the HAIS-TP referring to the HAIS nominal currents. This allows easier replacement of HAIS by HO-NP in existing applications.

**Application information**

| Number of primary turns | Primary current |                 |                  |                  |                  |
|-------------------------|-----------------|-----------------|------------------|------------------|------------------|
|                         | $I_{PN} = 40$ A | $I_{PN} = 60$ A | $I_{PN} = 120$ A | $I_{PN} = 128$ A | $I_{PN} = 150$ A |
| 1                       | 40 A            | 60 A            | 120 A            | 128 A            | 150 A            |
| 2                       | 20 A            | 30 A            | 60 A             | 64 A             | 75 A             |
| 4                       | 10 A            | 15 A            | 30 A             | 32 A             | 37.5 A           |

Possibilities between range selection and number of turns <sup>1)2)</sup>

Connection diagram

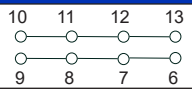
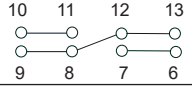
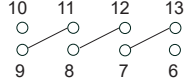
| Number of primary turns | Primary resistance current RMS $R_p$ (m $\Omega$ ) @ $T_A = 25$ °C | Recommended connections  |
|-------------------------|--|--|
| 1                       | 0.09   |  |
| 2                       | 0.36   |  |
| 4                       | 1.45   |  |

**Notes:** <sup>1)</sup> The standard configuration is with all jumpers in parallel (1 primary turn) which is the only one calibrated and guaranteed by LEM. The sensitivity may change slightly for all other configurations, therefore, LEM advises the user to characterize any specific configuration.

<sup>2)</sup> The maximum magnetic offset referred to primary is inversely proportional to the number of turns, thus is divided by 2 with 2 turns and by 4 with 4 turns.

**Definition of typical, minimum and maximum values**

Minimum and maximum values for specified limiting and safety conditions have to be understood as such as well as values shown in "typical" graphs.

On the other hand, measured values are part of a statistical distribution that can be specified by an interval with upper and lower limits and a probability for measured values to lie within this interval.

Unless otherwise stated (e.g. "100 % tested"), the LEM definition for such intervals designated with "min" and "max" is that the probability for values of samples to lie in this interval is 99.73 %.

For a normal (Gaussian) distribution, this corresponds to an interval between -3 sigma and +3 sigma. If "typical" values are not obviously mean or average values, those values are defined to delimit intervals with a probability of 68.27 %, corresponding to an interval between -sigma and +sigma for a normal distribution.

Typical, maximal and minimal values are determined during the initial characterization of the product.

**Remark**

Installation of the transducer must be done unless otherwise specified on the datasheet, according to LEM Transducer Generic Mounting Rules. Please refer to LEM document N°ANE120504 available on our Web site: <https://www.lem.com/en/file/3137/download/>.



Dimensions HO-NP series (in mm, general linear tolerance  $\pm 0.3$  mm)

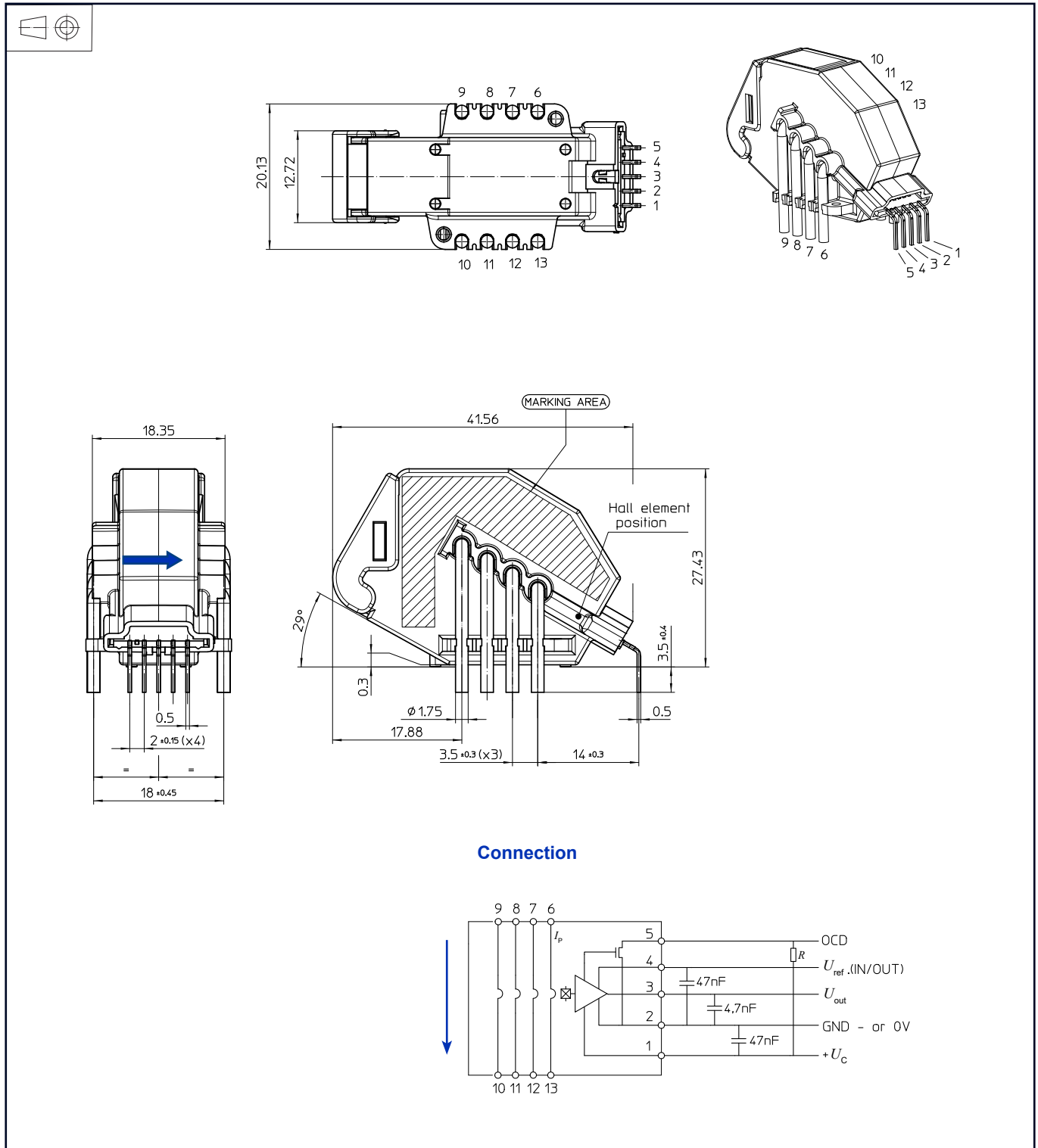

**Remark:**

- $U_{out}$  is positive with respect to  $U_{ref}$  when positive  $I_p$  flows in direction of the arrow shown on the drawing above.

单击下面可查看定价，库存，交付和生命周期等信息

[>>LEM\(莱姆\)](#)