

For the electronic measurement of voltage: DC, AC, pulsed..., with galvanic separation between the primary and the secondary circuit.

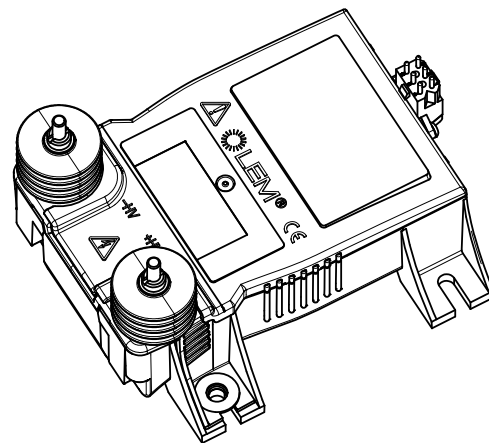

Features

- Bipolar and insulated voltage measurement up to 6 kV
- Current output
- Primary input connections by M5 studs
- Secondary output by Burndy connector
- Primary connection on top position
- Footprint compatible with OV, CV4 series and LV 200-AW/2 families.

Advantages

- Low consumption and losses
- Compact design
- Good behaviour under common mode variations
- Excellent accuracy (offset, sensitivity, linearity)
- Delay time 60 μs
- Low temperature drift
- High immunity to external interferences.

Applications

- Single or three phase inverters
- Propulsion and braking choppers
- Propulsion converters
- Auxiliary converters
- High power drives
- Substations
- On-board energy meters.

Standards

- EN 50155: 2017
- EN 50124-1: 2017
- EN 50121-3-2: 2016.

Application Domain

- Railway (fixed installations and onboard).

Absolute maximum ratings

Parameter	Symbol	Value
Maximum supply voltage ($U_p = 0 \text{ V}$, 0.1 s) =	$\pm \hat{U}_{C \text{ max}}$	$\pm 34 \text{ V}$
Maximum supply voltage (working) (-40 ... 85 °C) =	$\pm U_{C \text{ max}}$	$\pm 26.4 \text{ V}$
Maximum primary voltage (-40 ... 85 °C)	$U_{P \text{ max}}$	6 kV
Maximum steady state primary voltage (-40 ... 85 °C)	$U_{P \text{ N max}}$	4000 V see derating on figure 2

Absolute maximum ratings apply at 25 °C unless otherwise noted.
 Stresses above these ratings may cause permanent damage.
 Exposure to absolute maximum ratings for extended periods may degrade reliability.

Environmental and mechanical characteristics

Parameter	Symbol	Unit	Min	Typ	Max	Comment
Ambient operating temperature	T_A	°C	-40		85	
Ambient storage temperature	$T_{A \text{ st}}$	°C	-50		90	
Equipment operating temperature class						EN 50155: OT6
Switch-on extended operating temperature class						EN 50155: ST0
Rapid temperature variation class						EN 50155: H2
Conformal coating type						EN 50155: PC2
Relative humidity	RH	%			95	
Shock & vibration category and class						EN 50155: 1B, (EN 61373)
Mass	m	g		610		
Ingress protection rating				IP40		IEC 60529 by construction (Indoor use)
Pollution degree					PD4	Insulation voltage accordingly
Altitude		m			2000 ¹⁾	

Note: ¹⁾ Insulation coordination at 2000 m.

RAMS data

Parameter	Symbol	Unit	Min	Typ	Max	Comment
Useful life class						EN 50155: L4
Mean failure rate	$\bar{\lambda}$	h ⁻¹		1/1883371		According to IEC 62380 $T_A = 45 \text{ °C}$ ON: 20 hrs/day ON/OFF: 320 cycles/year $U_C = \pm 24 \text{ V}$, $U_p = 4000 \text{ V}$

Insulation coordination

Parameter	Symbol	Unit	Value	Comment
RMS voltage for AC insulation test, 50 Hz, 1 min	U_d	kV	18.5	100 % tested in production
Impulse withstand voltage 1.2/50 μ s	U_{Ni}	kV	30	
Partial discharge extinction RMS voltage @ 10 pC	U_e	V	5000	
Insulation resistance	R_{INS}	M Ω	200	Measured at 500 V DC
Clearance (pri. - sec.)	d_{Cl}	mm	see dimensions drawing on page 10	Shortest distance through air
Creepage distance (pri. - sec.)	d_{Cp}	mm		Shortest path along device body
Case material	-	-	V0	According to UL 94
Comparative tracking index	CTI		600	

Electrical data

At $T_A = 25\text{ °C}$, $\pm U_C = \pm 24\text{ V}$, $R_M = 100\ \Omega$, unless otherwise noted.

Lines with a * in the conditions column apply over the $-40 \dots 85\text{ °C}$ ambient temperature range.

Parameter	Symbol	Unit	Min	Typ	Max	Conditions
Primary nominal RMS voltage	U_{PN}	V			4000	*
Primary voltage, measuring range	U_{PM}	V	-6000		6000	*
Measuring resistance	R_M	Ω	0		133.3	* See derating on figure 2. For $ U_{PM} < 6\text{ kV}$, max value of R_M is given on figure 1
Secondary nominal RMS current	I_{SN}	mA			50	*
Secondary current	I_S	mA	-75		75	*
Supply voltage =	$\pm U_C$	V	± 13.5	± 24	± 26.4	*
Rise time of U_C (10-90 %)	t_{rise}	ms			100	
Current consumption =	I_C	mA		$20 + I_S$	$25 + I_S$	@ $U_C = \pm 24\text{ V}$ at $U_p = 0\text{ V}$
Inrush current						NA (EN 50155)
Interruptions on power supply voltage class						NA (EN 50155)
Supply change-over class						NA (EN 50155)
Electrical Offset current	I_{OE}	μA	-50	0	50	100 % tested in production
Temperature variation of $I_o @ U_p = 0$	I_{OT}	μA	-80 -80 -100		80 80 100	* -25 ... 70 °C -25 ... 85 °C -40 ... 85 °C, 100 % tested in production
Sensitivity	S	$\mu\text{A/V}$		12.5		50 mA for 4000 V
Sensitivity error	ε_s	%	-0.2	0	0.2	100 % tested in production
Temperature variation of sensitivity error	ε_{ST}	%	-0.5 -0.8 -0.8		0.5 0.8 0.8	* -25 ... 70 °C -25 ... 85 °C -40 ... 85 °C
Linearity error	ε_L	% of U_{PM}	-0.1		0.1	* $\pm 6000\text{ V}$ range
Total error	ε_{tot}	% of U_{PN}	-0.3 -0.7 -1 -1		0.3 0.7 1 1	* 25 °C; 100 % tested in production -25 ... 70 °C -25 ... 85 °C -40 ... 85 °C
RMS noise current	I_{no}	μA		10		1 Hz to 100 kHz
Delay time @ 10 % of the final output value U_{PN} step	t_{D10}	μs		21		
Delay time @ 90 % of the final output value U_{PN} step	t_{D90}	μs		48	60	0 to 4000 V step, 6 kV/ μs
Frequency bandwidth	BW	kHz		12 6.5 1.6		3 dB 1 dB 0.1 dB
Start-up time	t_{start}	ms		190	250	*
Resistance of primary (winding)	R_p	M Ω		23		*
Total primary power loss @ U_{PN}	P_p	W		0.69		*

Definition of typical, minimum and maximum values

Minimum and maximum values for specified limiting and safety conditions have to be understood as such as well as values shown in “typical” graphs.

On the other hand, measured values are part of a statistical distribution that can be specified by an interval with upper and lower limits and a probability for measured values to lie within this interval.

Unless otherwise stated (e.g. “100 % tested”), the LEM definition for such intervals designated with “min” and “max” is that the probability for values of samples to lie in this interval is 99.73 %.

For a normal (Gaussian) distribution, this corresponds to an interval between -3 sigma and $+3$ sigma. If “typical” values are not obviously mean or average values, those values are defined to delimit intervals with a probability of 68.27 %, corresponding to an interval between $-\text{sigma}$ and $+\text{sigma}$ for a normal distribution.

Typical, maximal and minimal values are determined during the initial characterization of the product.

Typical performance characteristics

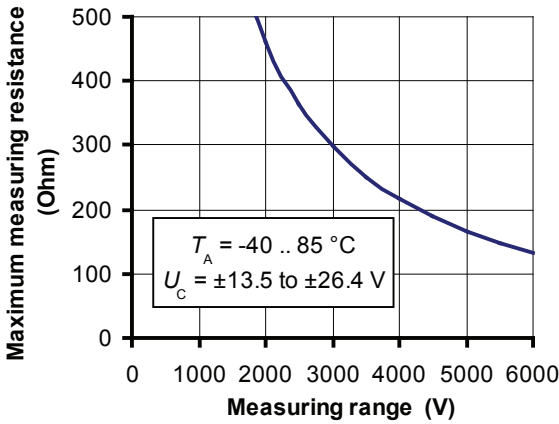

Figure 1: Maximum measuring resistance

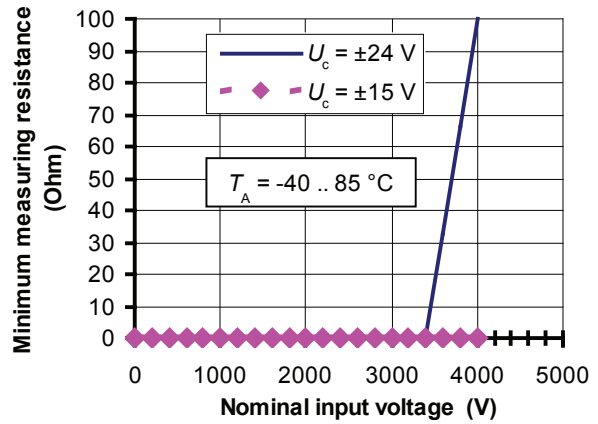

Figure 2: Minimum measuring resistance
For T_A under $80\text{ }^\circ\text{C}$, the minimum measuring resistance is $0\text{ }\Omega$ whatever U_C

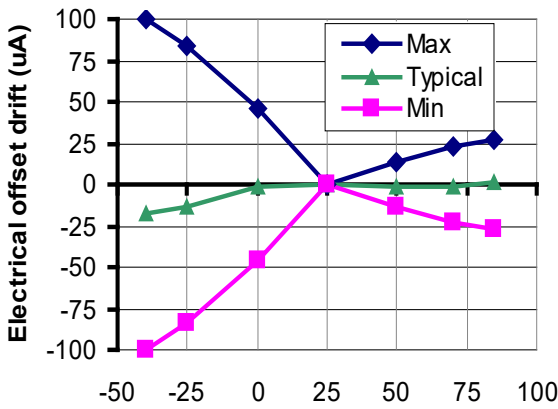

Figure 3: Electrical offset thermal drift

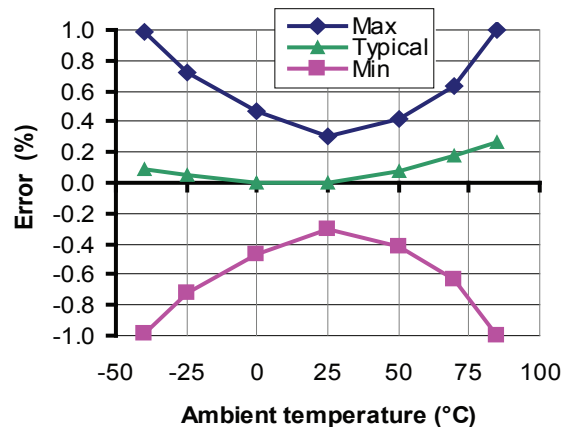

Figure 4: Total error in temperature

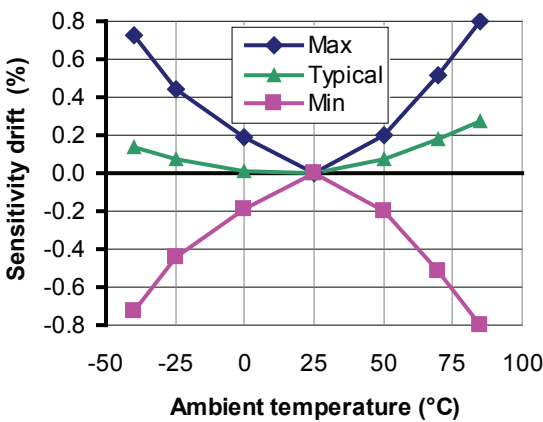

Figure 5: Sensitivity thermal drift

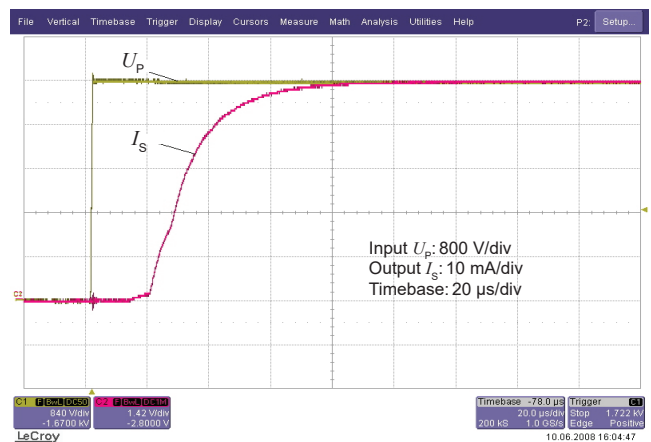

Figure 6: Typical step response (0 to 4000 V)

Typical performance characteristics continued

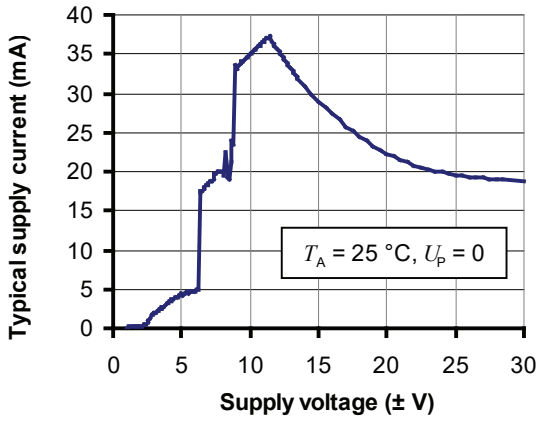

Figure 7: Supply current function of supply voltage

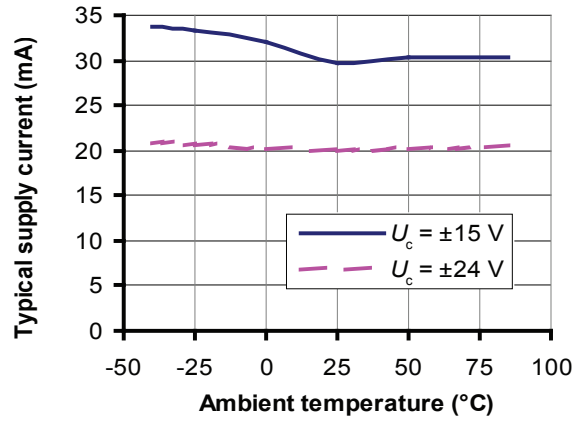

Figure 8: Supply current function of temperature

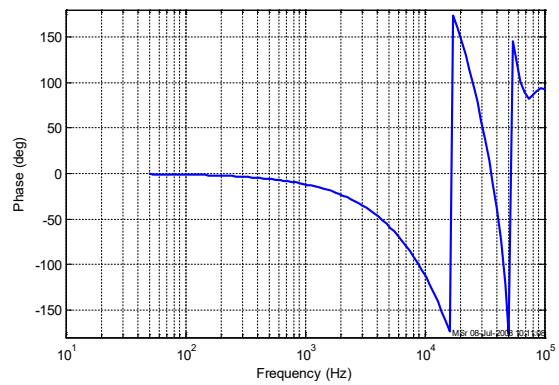
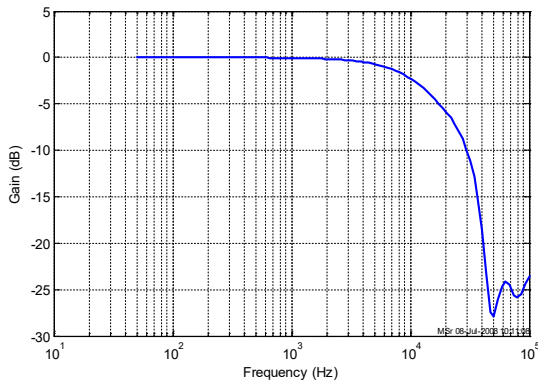

Figure 9: Typical frequency response

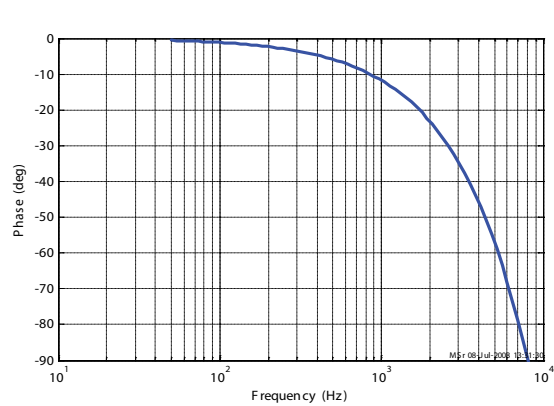
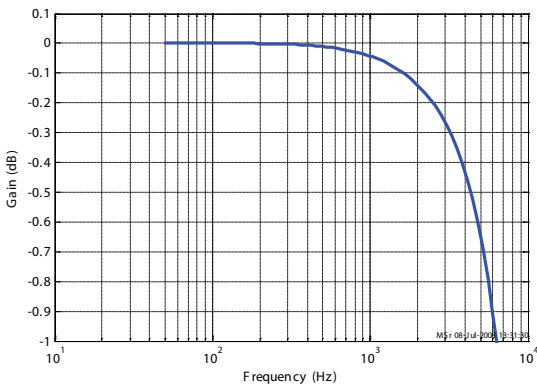

Figure 10: Typical frequency response (detail)

Typical performance characteristics continued

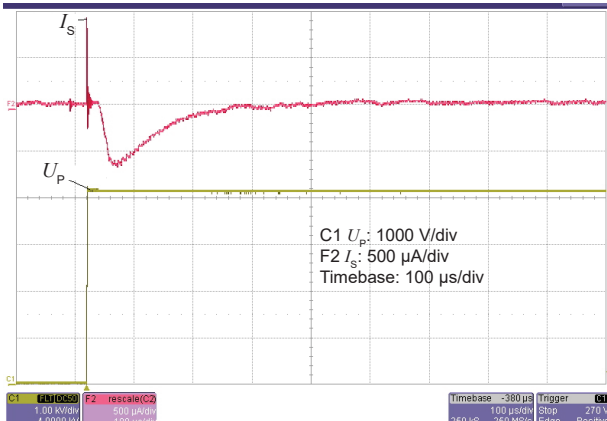

Figure 11: Typical common mode perturbation (4200 V step with 6 kV/µs, $R_M = 100 \Omega$)

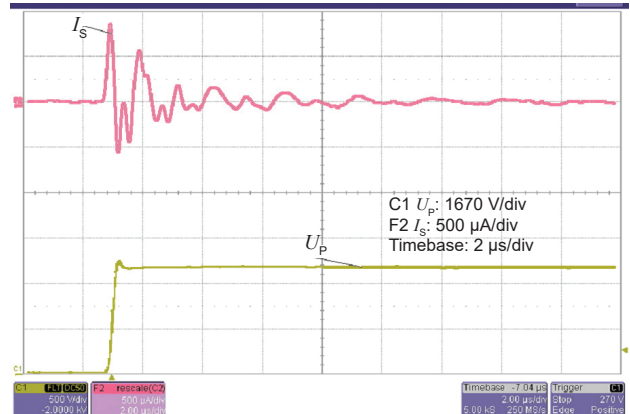

Figure 12: Detail of typical common mode perturbation (4000 V step with 6 kV/µs, $R_M = 100 \Omega$)

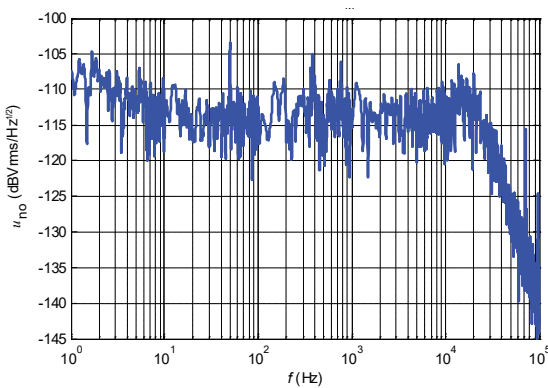

Figure 13 Typical RMS noise voltage spectral density referred to primary with $R_M = 50 \Omega$

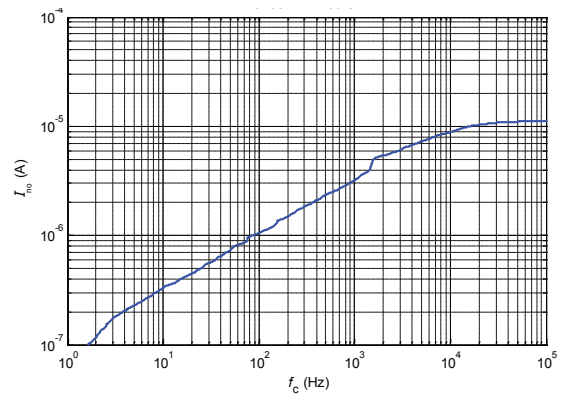

Figure 14: Typical total RMS noise current with $R_M = 50 \Omega$ (f_c is upper cut off frequency of band pass, low cut off frequency is 1 Hz)

Figure 13 (RMS noise voltage density) shows that there are no significant discrete frequencies in the output. Figure 14 confirms the absence of steps in the total RMS noise current that would indicate discrete frequencies. To calculate the noise in a frequency band f_1 to f_2 , the formula is:

$$I_{no}(f_1 \text{ to } f_2) = \sqrt{I_{no}(f_2)^2 - I_{no}(f_1)^2}$$

with $I_{no}(f)$ read from figure 14 (typical, RMS value).

Example:

What is the noise from 10 to 100 Hz?

Figure 14 gives $I_{no}(10 \text{ Hz}) = 0.32 \mu\text{A}$ and $I_{no}(100 \text{ Hz}) = 1 \mu\text{A}$. The RMS current noise is therefore.

$$\sqrt{(1 \times 10^{-6})^2 - (0.32 \times 10^{-6})^2} = 0.95 \mu\text{A}$$

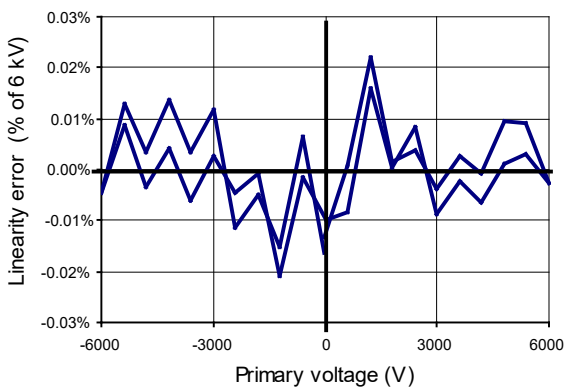

Figure 15: Typical linearity error

Performance parameters definition

The schematic used to measure all electrical parameters are:

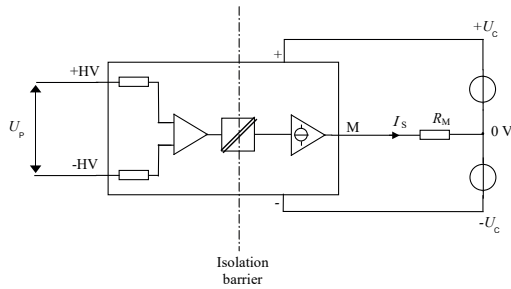

Figure 16: standard characterization schematics for current output transducers ($R_M = 50 \Omega$ unless otherwise noted)

Transducer simplified model

The static model of the transducer at temperature T_A is:

$$I_s = S \cdot U_p + \varepsilon$$

In which

$$\varepsilon = I_{OE} + I_{OT}(T_A) + \varepsilon_S \cdot S \cdot U_p + \varepsilon_{ST}(T_A) \cdot S \cdot U_p + \varepsilon_L \cdot S \cdot U_{PM}$$

- I_s : secondary current (A)
- S : sensitivity of the transducer ($\mu A/V$)
- U_p : primary voltage (V)
- U_{PM} : primary voltage, measuring range (V)
- T_A : ambient operating temperature ($^{\circ}C$)
- I_{OE} : electrical offset current (A)
- $I_{OT}(T_A)$: temperature variation of I_{OE} at temperature T_A (μA)
- ε_S : sensitivity error at $25^{\circ}C$
- $\varepsilon_{ST}(T_A)$: thermal drift of sensitivity error at temperature T_A
- ε_L : linearity error

This is the absolute maximum error. As all errors are independent, a more realistic way to calculate the error would be to use the following formula:

$$\varepsilon = \sqrt{\sum_{i=1}^N \varepsilon_i^2}$$

Sensitivity and linearity

To measure sensitivity and linearity, the primary voltage (DC) is cycled from 0 to U_{PM} , then to $-U_{PM}$ and back to 0 (equally spaced $U_{PM}/10$ steps).

The sensitivity S is defined as the slope of the linear regression line for a cycle between $\pm U_{PM}$.

The linearity error ε_L is the maximum positive or negative difference between the measured points and the linear regression line, expressed in % of the maximum measured value.

Electrical offset

The electrical offset current I_{OE} is the residual output current when the input voltage is zero.

The temperature variation I_{OT} of the electrical offset current I_{OE} is the variation of the electrical offset from $25^{\circ}C$ to the considered temperature.

Total error

The total error ε_{tot} is the error at $\pm U_{PN}$, relative to the rated value U_{PN} .

It includes all errors mentioned above.

Delay times

The delay time t_{D10} @ 10 % and the delay time t_{D90} @ 90 % with respect to the primary are shown in the next figure.

Both slightly depend on the primary voltage dv/dt . They are measured at nominal voltage.

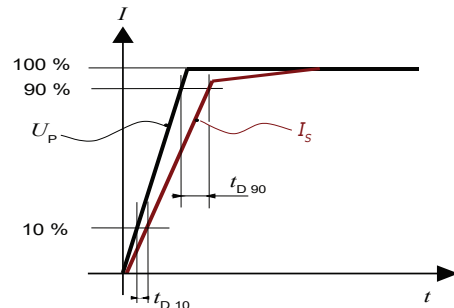
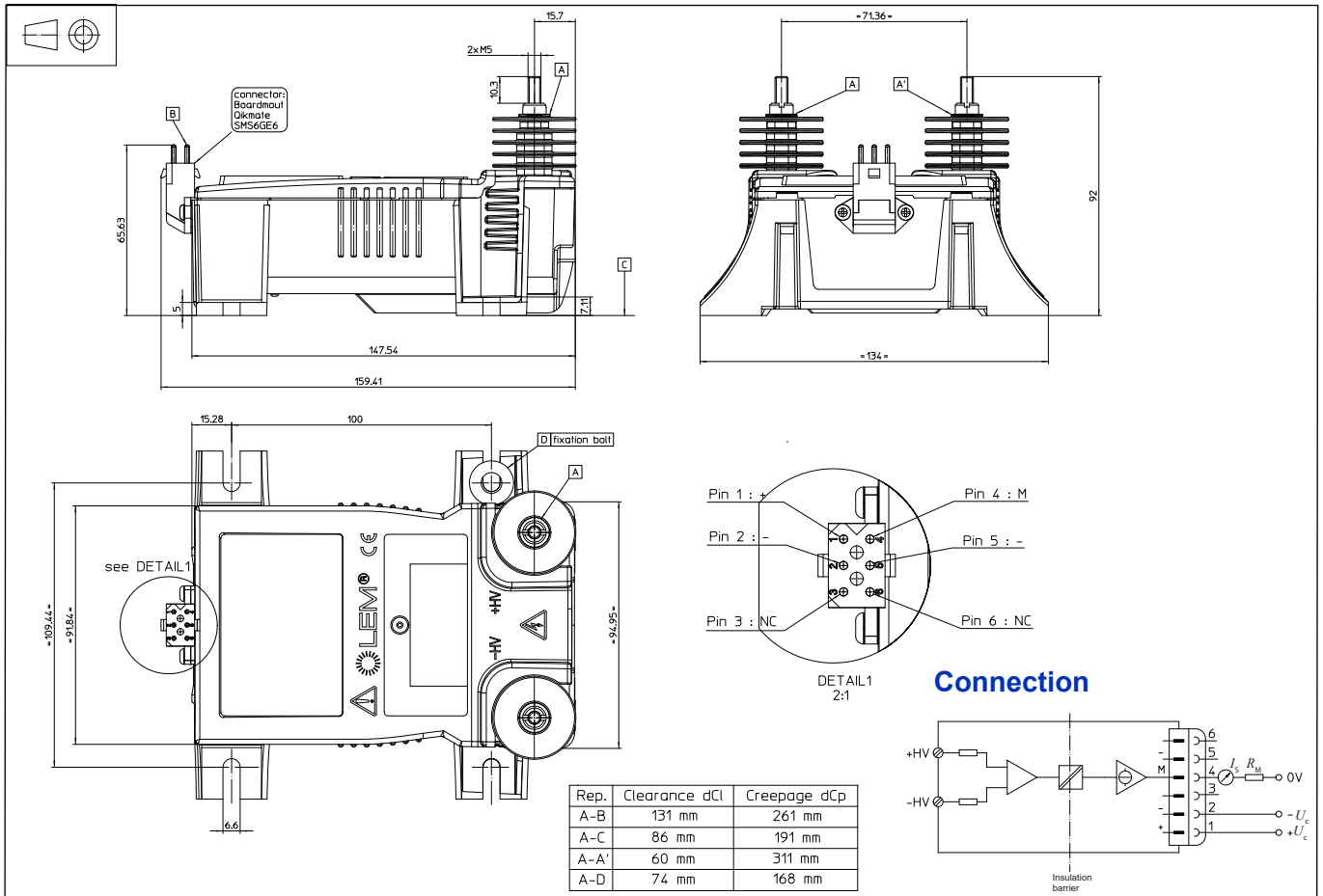

Figure 17: delay time t_{D10} @ 10 % and delay time t_{D90} @ 90 %.

Dimensions (in mm)

Mechanical characteristics

- General tolerance ± 1 mm
- Transducer fastening 4 M6 steel screws
4 washers of ext. \varnothing 18 mm
- Recommended fastening torque 5 N·m
- Connection of primary M5 threaded studs
Recommended fastening torque 2.2 N·m
- Connection of secondary Burndy SMS6GE6

Remarks

- I_s is positive when a positive voltage is applied on +HV.
- The transducer is directly connected to the primary voltage.
- The primary cables have to be routed together all the way.
- The secondary cables also have to be routed together all the way
- Installation of the transducer is to be done without primary or secondary voltage present
- Installation of the transducer must be done unless otherwise specified on the datasheet, according to LEM Transducer Generic Mounting Rules. Please refer to LEM document N°ANE120504 available on our Web site:

[Products/Product Documentation.](#)

Note: Additional information available on request.

Safety

This transducer must be used in limited-energy secondary circuits according to IEC 61010-1.



This transducer must be used in electric/electronic equipment with respect to applicable standards and safety requirements in accordance with the manufacturer's operating instructions.



Caution, risk of electrical shock

When operating the transducer, certain parts of the module can carry hazardous voltage (e.g. primary connections, power supply). Ignoring this warning can lead to injury and/or cause serious damage. This transducer is a build-in device, whose conducting parts must be inaccessible after installation. A protective housing or additional shield could be used. Main supply must be able to be disconnected.

单击下面可查看定价，库存，交付和生命周期等信息

[>>LEM\(莱姆\)](#)