

# Voltage transducer DVL 2000/SP6

$V_{PN} = 2000\text{ V}$

For the electronic measurement of voltage: DC, AC, pulsed..., with galvanic separation between the primary and the secondary circuit.

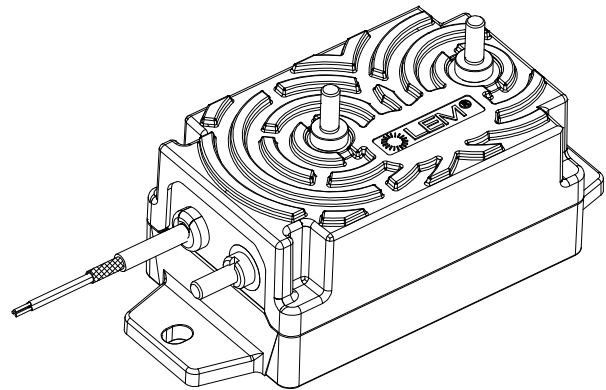

## Features

- Bipolar and insulated measurement up to 3000 V
- Current output
- Input connection with M5 studs
- Compatible with AV 100 family.

## Special feature

- Cable is used for secondary connection.

## Advantages

- Low consumption and low losses
- Compact design
- Good behavior under common mode variations
- Excellent accuracy (offset, sensitivity, linearity)
- Good response time
- Low temperature drift
- High immunity to external interferences.

## Applications

- Single or three phase inverter
- Propulsion and braking chopper
- Propulsion converter
- Auxiliary converter
- High power drives
- Substations.

## Standards

- EN 50155: 2017
- EN 50178: 1997
- EN 50124-1: 2001
- EN 50121-3-2: 2006
- UL 347: 2016
- IEC 61010-1: 2010.

## Application Domain

- Railway (fixed installations and onboard)
- Industrial.

**Absolute maximum ratings**

Parameter	Symbol	Unit	Value
Maximum supply voltage ( $V_p = 0$ V, 0.1 s)	$\pm U_{C\max}$	V	$\pm 34$
Maximum supply voltage (working) (-40 ... 85 °C)	$\pm U_{C\max}$	V	$\pm 26.4$
Maximum primary voltage (-40 ... 85 °C)	$V_{P\max}$	V	3000
Maximum steady state primary voltage (-40 ... 85 °C)	$V_{PN\max}$	V	2000 see derating on figure 2

Absolute maximum ratings apply at 25 °C unless otherwise noted.  
 Stresses above these ratings may cause permanent damage.  
 Exposure to absolute maximum ratings for extended periods may degrade reliability.

**UL 347: Ratings and assumptions of certification**

File # E315896 Volume: 1 Section: 2

**Standards**

- USR indicates that the product covered by this Report has been investigated to UL, LLC Standard for Safety for Medium-Voltage AC Contractors, Controllers, and Control Centers, UL 347.

**Conditions of acceptability**

When installed in the end-use equipment, consideration shall be given to the following:

- 1 - *These devices must be mounted in a suitable end-use enclosure.*
- 2 - *The terminals have not been evaluated for field wiring.*
- 3 - *The rated Basic Insulation Level (BIL) is 20kV for this device, after performing Impulse Withstand Tests. Additional testing will be required if a higher BIL rating is desired.*

**Marking**

Only those products bearing the UL or UR Mark should be considered to be Listed or Recognized and covered under UL's Follow-Up Service. Always look for the Mark on the product.

**Insulation coordination**

Parameter	Symbol	Unit	Value	Comment
RMS voltage for AC insulation test, 50/60 Hz, 1 min	$U_d$	kV	8.5	100 % tested in production
Impulse withstand voltage 1.2/50 $\mu$ s	$\hat{U}_w$	kV	12	
Partial discharge extinction RMS voltage @ 10 pC	$U_e$	V	2700	
Insulation resistance	$R_{INS}$	M $\Omega$	200	measured at 500 V DC
Clearance (pri. - sec.)	$d_{Cl}$	mm	See dimensions drawing on page 9	Shortest distance through air
Creepage distance (pri. - sec.)	$d_{Cp}$	mm		Shortest path along device body
Case material	-	-	V0 according to UL 94	
Comparative tracking index	$CTI$		600	

**Environmental and mechanical characteristics**

Parameter	Symbol	Unit	Min	Typ	Max
Ambient operating temperature	$T_A$	$^{\circ}$ C	-40		85
Ambient storage temperature	$T_s$	$^{\circ}$ C	-50		90
Equipment operating temperature class					EN 50155: OT6
Switch-on extended operating temperature class					EN 50155: ST0
Rapid temperature variation class					EN 50155: H2
Conformal coating type					EN 50155: PC2
Mass	$m$	g		350	

**RAMS data**

Parameter	Symbol	Unit	Min	Typ	Max
Useful life class					EN 50155: L4
Mean failure rate	$\bar{\lambda}$	$h^{-1}$		1/1835004	According to IEC 62380: 2004 $T_A = 45^{\circ}$ C ON: 20 hrs/day ON/OFF: 320 cycles/year $U_C = \pm 24$ V, $U_P = 2000$ V

## Electrical data

At  $T_A = 25\text{ °C}$ ,  $\pm U_C = \pm 24\text{ V}$ ,  $R_M = 100\ \Omega$ , unless otherwise noted.

Lines with a \* in the conditions column apply over the  $-40 \dots 85\text{ °C}$  ambient temperature range.

Parameter	Symbol	Unit	Min	Typ	Max	Conditions
Primary nominal RMS voltage	$V_{PN}$	V		2000		*
Primary voltage, measuring range	$V_{PM}$	V	-3000		3000	*
Measuring resistance	$R_M$	$\Omega$	0		133	* See derating on figure 2. For $ V_{PM}  < 3000\text{ V}$ , max value of $R_M$ is given on figure 1
Secondary nominal RMS current	$I_{SN}$	mA		50		*
Secondary current	$I_S$	mA	-75		75	*
Supply voltage	$\pm U_C$	V	$\pm 13.5$	$\pm 24$	$\pm 26.4$	*
Rise time of $U_C$ (10-90 %)	$t_{rise}$	ms			100	
Current consumption @ $U_C = \pm 24\text{ V}$ at $V_P = 0\text{ V}$	$I_C$	mA		20	25	
Inrush current						NA (EN 50155)
Interruptions on power supply voltage class						NA (EN 50155)
Supply change-over class						NA (EN 50155)
Offset current	$I_O$	$\mu\text{A}$	-50	0	50	100 % tested in production
Temperature variation of $I_O$	$I_{OT}$	$\mu\text{A}$	-120 -150		120 150	-25 ... 85 °C -40 ... 85 °C
Sensitivity	$G$	$\mu\text{A/V}$		25		50 mA for primary 2000 V
Sensitivity error	$\varepsilon_G$	%	-0.2	0	0.2	
Thermal drift of sensitivity	$\varepsilon_{GT}$	%	-0.5		0.5	*
Linearity error	$\varepsilon_L$	% of $V_{PM}$	-0.5		0.5	* $\pm 3000\text{ V}$ range
Overall accuracy	$X_G$	% of $V_{PN}$	-0.5 -1		0.5 1	* 25 °C; 100 % tested in production -40 ... 85 °C
Output RMS noise current	$I_{no}$	$\mu\text{A}$		10		1 Hz to 100 kHz
Reaction time @ 10 % of $V_{PN}$	$t_{ra}$	$\mu\text{s}$		30		
Response time @ 90 % of $V_{PN}$	$t_r$	$\mu\text{s}$		50	60	0 to 2000 V step, 6 kV/ $\mu\text{s}$
Frequency bandwidth	$BW$	kHz		14 8 2		-3 dB -1 dB -0.1 dB
Start-up time	$t_{start}$	ms		190	250	*
Resistance of primary (winding)	$R_P$	M $\Omega$		11.3		*
Total primary power loss @ $V_{PN}$	$P_P$	mW		0.35		*

## Definition of typical, minimum and maximum values

Minimum and maximum values for specified limiting and safety conditions have to be understood as such as well as values shown in "typical" graphs.

On the other hand, measured values are part of a statistical distribution that can be specified by an interval with upper and lower limits and a probability for measured values to lie within this interval.

Unless otherwise stated (e.g. "100 % tested"), the LEM definition for such intervals designated with "min" and "max" is that the probability for values of samples to lie in this interval is 99.73 %.

For a normal (Gaussian) distribution, this corresponds to an interval between -3 sigma and +3 sigma. If "typical" values are not obviously mean or average values, those values are defined to delimit intervals with a probability of 68.27 %, corresponding to an interval between -sigma and +sigma for a normal distribution.

Typical, maximal and minimal values are determined during the initial characterization of a product.

Typical performance characteristics

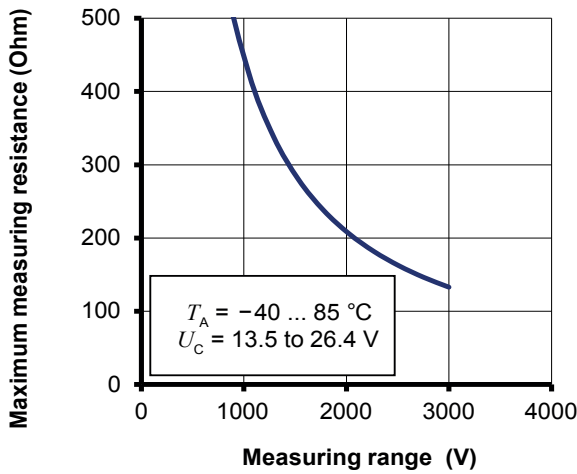

Figure 1: Maximum measuring resistance

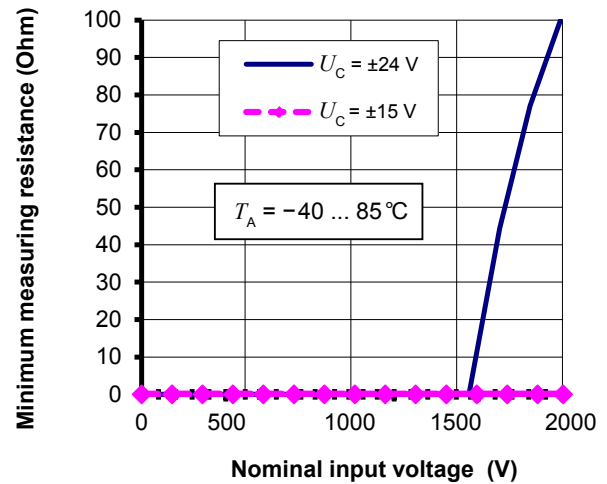

Figure 2: Minimum measuring resistance  
For  $T_A$  under 80 °C, the minimum measuring resistance is 0  $\Omega$  whatever  $U_C$

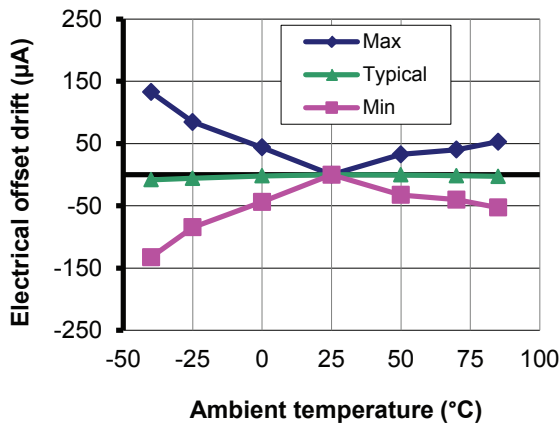

Figure 3: Electrical offset thermal drift

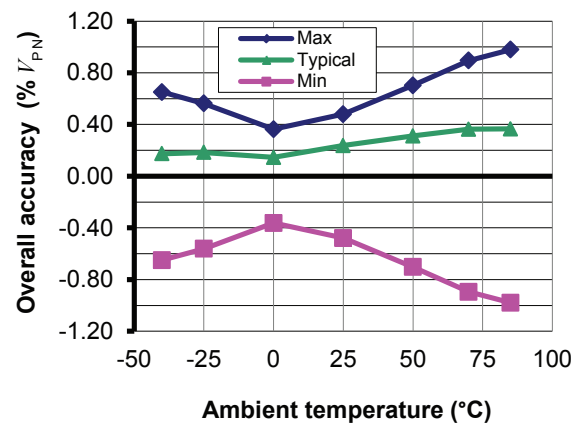

Figure 4: Overall accuracy in temperature

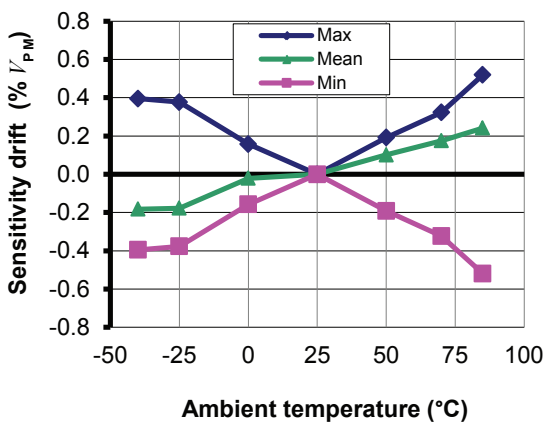

Figure 5: Sensitivity thermal drift

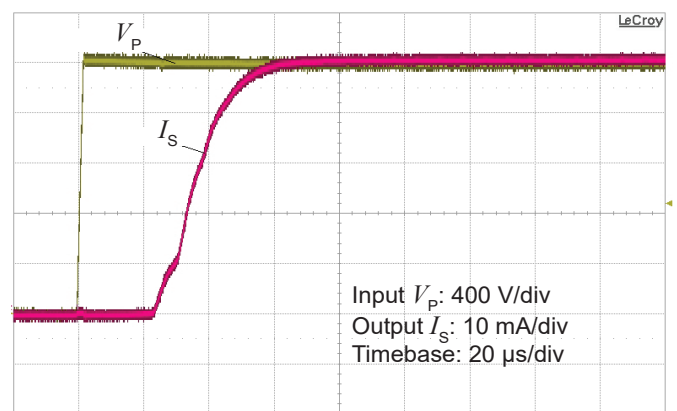

Figure 6: Typical step response (0 to 2000 V)

Typical performance characteristics continued

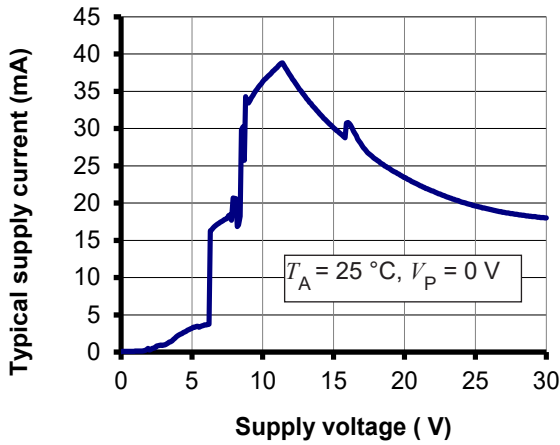

Figure 7: Supply current function of supply voltage

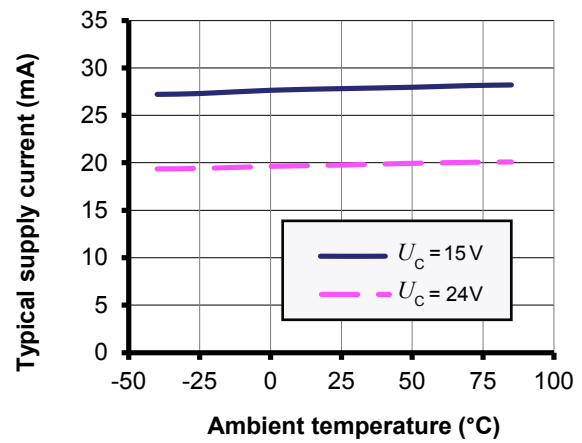

Figure 8: Supply current function of temperature

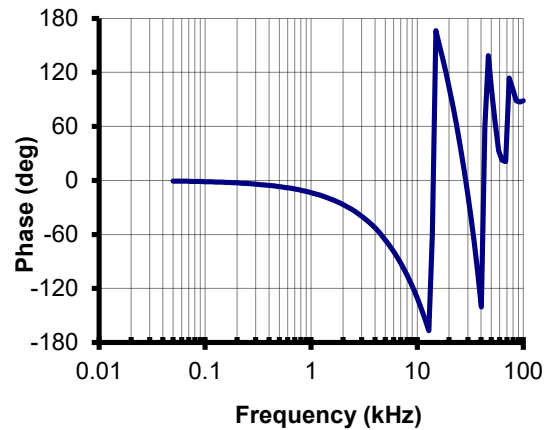
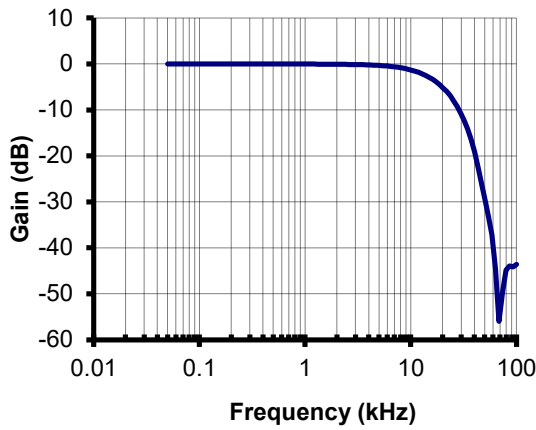

Figure 9: Typical frequency and phase response

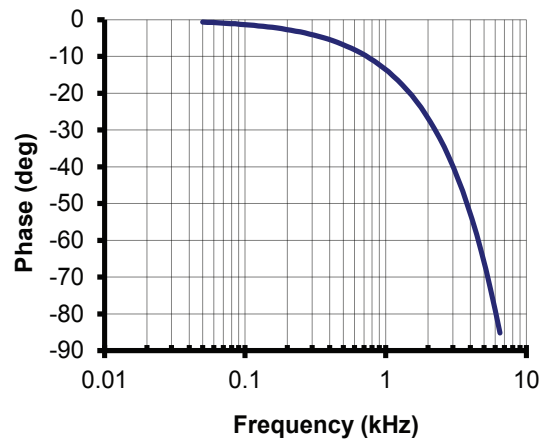
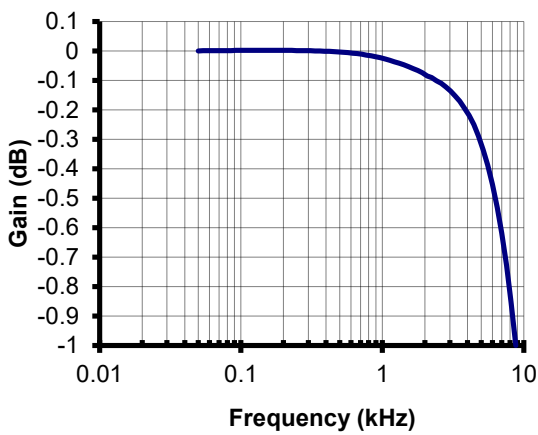

Figure 10: Typical frequency and phase response (detail)

Typical performance characteristics continued

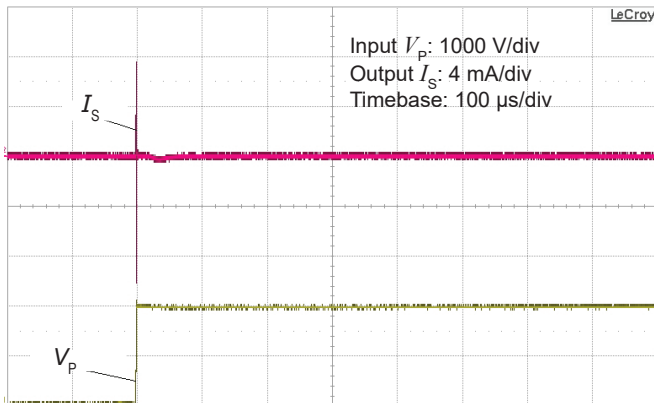

Figure 11: Typical common mode perturbation (2000 V step with 6 kV/μs  $R_M = 100 \Omega$ )

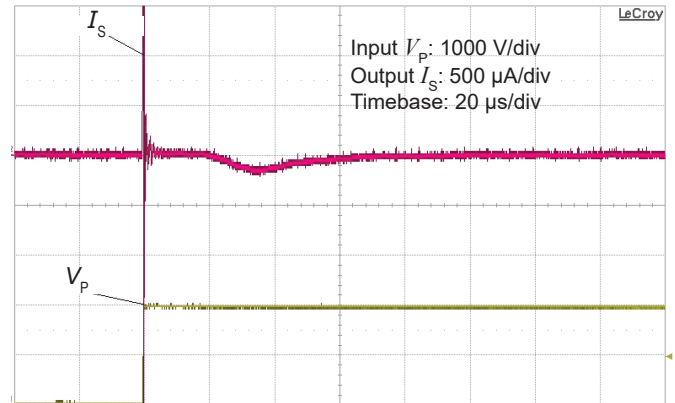

Figure 12: Detail of typical common mode perturbation (2000 V step with 6 kV/μs,  $R_M = 100 \Omega$ )

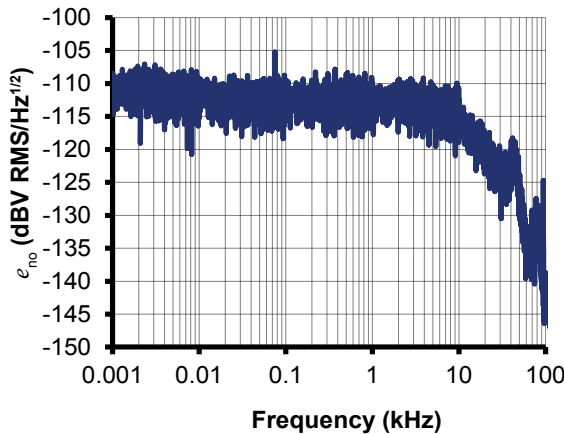

Figure 13: Typical output RMS noise voltage spectral density  $e_{no}$  with  $R_M = 50 \Omega$

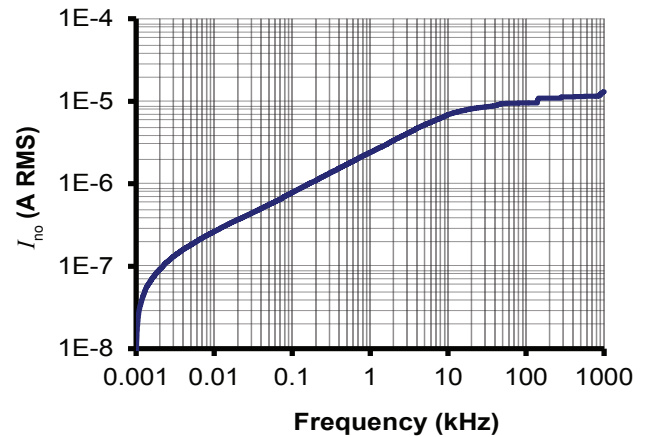

Figure 14: Typical total output RMS noise current with  $R_M = 50 \Omega$  ( $f_c$  is upper cut-off frequency of bandpass, low cut off frequency is 1 Hz)

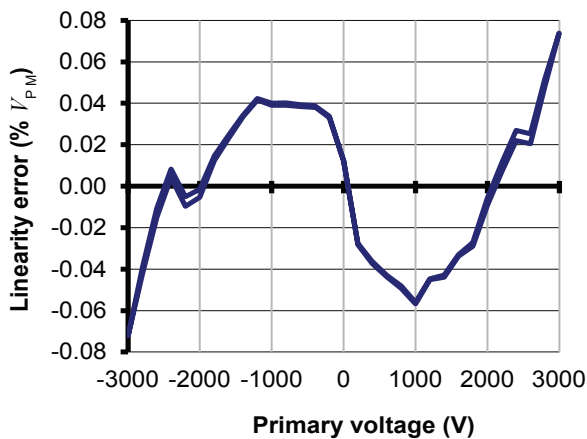

Figure 15: Typical linearity error at 25 °C

Figure 13 (output RMS noise voltage spectral density) shows that there are no significant discrete frequencies in the output. Figure 14 confirms the absence of steps in the total output RMS noise current that would indicate discrete frequencies. To calculate the noise in a frequency band  $f_1$  to  $f_2$ , the formula is:

$$I_{no}(f_1 \text{ to } f_2) = \sqrt{I_{no}(f_2)^2 - I_{no}(f_1)^2}$$

with  $I_{no}(f)$  read from figure 14 (typical, RMS value).

Example:

What is the noise from 10 to 100 Hz?

Figure 14 gives  $I_{no}(10 \text{ Hz}) = 0.26 \mu\text{A}$  and

$I_{no}(100 \text{ Hz}) = 0.8 \mu\text{A}$ .

The output RMS noise current is therefore.

$$\sqrt{(0.8 \times 10^{-6})^2 - (0.26 \times 10^{-6})^2} = 0.76 \mu\text{A}$$

### Performance parameters definition

The schematic used to measure all electrical parameters are:

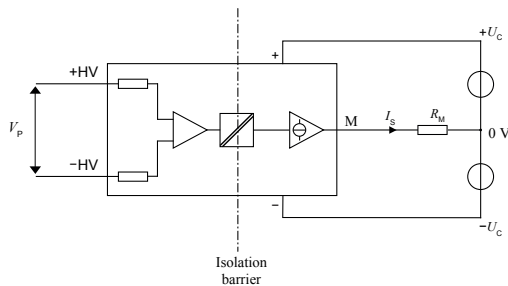

Figure 16: standard characterization schematics for current output transducers ( $R_M = 50 \Omega$  unless otherwise noted)

### Transducer simplified model

The static model of the transducer at temperature  $T_A$  is:

$$I_S = G \cdot V_P + \varepsilon$$

In which

$$\varepsilon = I_{OE} + I_{OT}(T_A) + \varepsilon_G \cdot G \cdot V_P + \varepsilon_{GT}(T_A) \cdot G \cdot V_P + \varepsilon_L \cdot G \cdot V_{PM}$$

- $I_S$  : secondary current (A)
- $G$  : sensitivity of the transducer ( $\mu A/V$ )
- $V_P$  : primary voltage (V)
- $V_{PM}$  : primary voltage, measuring range (V)
- $T_A$  : ambient operating temperature ( $^{\circ}C$ )
- $I_{OE}$  : electrical offset current (A)
- $I_{OT}(T_A)$  : temperature variation of  $I_{OE}$  at temperature  $T_A$  (A)
- $\varepsilon_G$  : sensitivity error at  $25^{\circ}C$
- $\varepsilon_{GT}(T_A)$  : thermal drift of sensitivity at temperature  $T_A$
- $\varepsilon_L$  : linearity error

This is the absolute maximum error. As all errors are independent, a more realistic way to calculate the error would be to use the following formula:

$$\varepsilon = \sqrt{\sum_{i=1}^N \varepsilon_i^2}$$

### Sensitivity and linearity

To measure sensitivity and linearity, the primary voltage (DC) is cycled from 0 to  $V_{PM}$ , then to  $-V_{PM}$  and back to 0 (equally spaced  $V_{PM}/10$  steps).

The sensitivity  $G$  is defined as the slope of the linear regression line for a cycle between  $\pm V_{PM}$ .

The linearity error  $\varepsilon_L$  is the maximum positive or negative difference between the measured points and the linear regression line, expressed in % of the maximum measured value.

### Electrical offset

The electrical offset current  $I_{OE}$  is the residual output current when the input voltage is zero.

The temperature variation  $I_{OT}$  of the electrical offset current  $I_{OE}$  is the variation of the electrical offset from  $25^{\circ}C$  to the considered temperature.

### Overall accuracy

The overall accuracy  $X_G$  is the error at  $\pm V_{PN}$ , relative to the rated value  $V_{PN}$ .

It includes all errors mentioned above.

### Response and reaction times

The response time  $t_r$  and the reaction time  $t_{ra}$  are shown in the next figure.

Both depend on the primary voltage  $dv/dt$ . They are measured at nominal voltage.

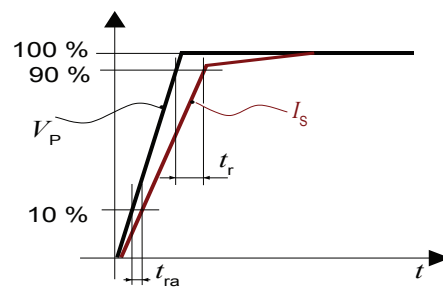
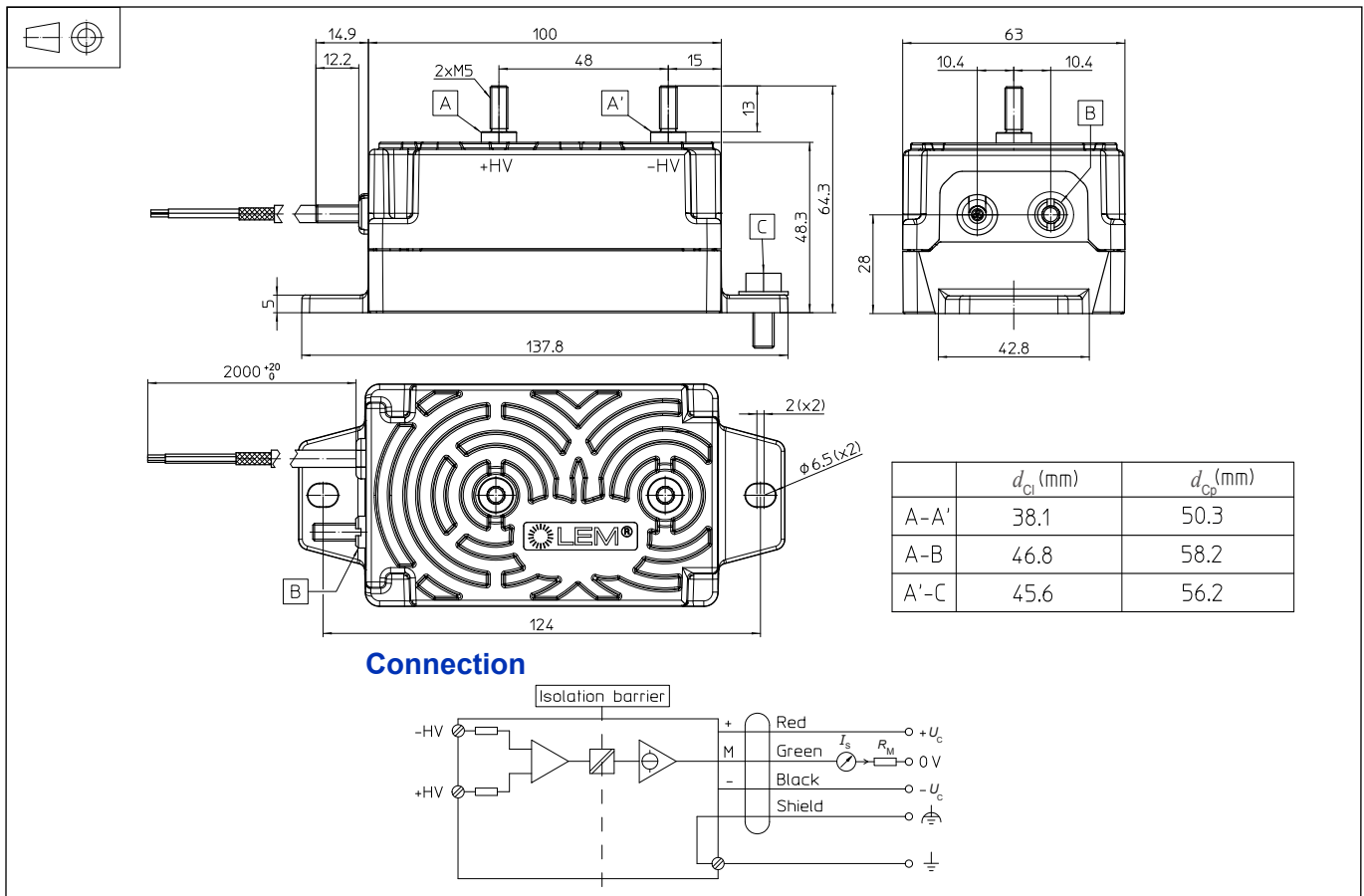

Figure 17: response time  $t_r$  and reaction time  $t_{ra}$



**Dimensions (in mm)**

**Mechanical characteristics**

- General tolerance  $\pm 1$  mm
- Transducer fastening
  - 2 holes  $\varnothing$  6.5 mm
  - 2 M6 steel screws
  - Recommended fastening torque 4 N·m
- Connection of primary
  - 2 M5 threaded studs
  - Recommended fastening torque 2.2 N·m
- Connection of secondary
  - shielded cable 2 m
  - GKW-LW/S 3 x 0.5 mm<sup>2</sup>
- Earth connection
  - M5 threaded stud
  - Recommended fastening torque 2.2 N·m

**Remarks**

- $I_s$  is positive when a positive voltage is applied on +HV.
- The transducer is directly connected to the primary voltage.
- The primary cables have to be routed together all the way.
- The secondary cables also have to be routed together all the way.
- Installation of the transducer is to be done without primary or secondary voltage present
- Installation of the transducer must be done unless otherwise specified in the datasheet, according to LEM Transducer Generic Mounting Rules. Please refer to LEM document N°ANE120504 available on our Web site: <https://www.lem.com/en/file/3137/download/>.

Note: Additional information available on request.

**Safety**

This transducer must be used in limited-energy secondary circuits according to IEC 61010-1.



This transducer must be used in electric/electronic equipment with respect to applicable standards and safety requirements in accordance with the manufacturer's operating instructions.



Caution, risk of electrical shock

When operating the transducer, certain parts of the module can carry hazardous voltage (e.g. primary connections, power supply). Ignoring this warning can lead to injury and/or cause serious damage. This transducer is a build-in device, whose conducting parts must be inaccessible after installation. A protective housing or additional shield could be used. Main supply must be able to be disconnected.

单击下面可查看定价，库存，交付和生命周期等信息

[>>LEM\(莱姆\)](#)