

Digital Current Transducer HLSR-PW series $I_{PN} = 16 \dots 50 \text{ A}$

Ref: HLSR 16-PW; HLSR 32-PW; HLSR 40-PW; HLSR 50-PW

Bitstream output from on onboard Sigma Delta modulator. For the electronic measurement of current: DC, AC, pulsed..., with galvanic separation between the primary and the secondary circuit.

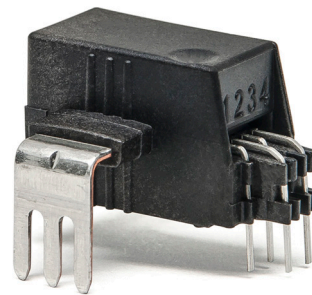

Features

- Open loop multi-range current transducer
- Bitstream output from 2nd order Sigma-Delta modulator, (PDM) Pulse Density Modulation
- Single supply +5 V
- Galvanic separation between primary and secondary circuit
- Low power consumption
- Compact design for through-hole PCB mounting
- Factory calibrated
- High bandwidth, very low loss magnetic core
- Dedicated parameter settings available on request (see page 13).

Advantages

- Extremely low profile: h = 12 mm
- Low foot-print
- Low offset drift.

Applications

- AC variable speed and servo motor drives
- Static converters for DC motor drives
- Battery supplied applications
- Uninterruptible Power Supplies (UPS)
- Switched Mode Power Supplies (SMPS)
- Power supplies for welding applications
- Combiner box
- Solar inverter on DC side of the inverter (MPPT).

Standards

- IEC 61800-2: 2015
- IEC 61800-3: 2017
- IEC 61800-5-1: 2007
- IEC 62109-1: 2010
- UL 508: 2013.

Application Domain

- Industrial.

Absolute maximum ratings

Parameter	Symbol	Unit	Value
Maximum supply voltage (not destructive)	$U_{C\ max}$	V	8
Maximum supply voltage (not entering non standard modes)	$U_{C\ max}$	V	6.5
Maximum primary conductor temperature	$T_{B\ max}$	°C	120
Electrostatic discharge voltage (HBM - Human Body Model)	$U_{ESD\ HBM}$	kV	2

Stresses above these ratings may cause permanent damage. Exposure to absolute maximum ratings for extended periods may degrade reliability.

UL 508: Ratings and assumptions of certification

File # E189713 Volume: 2 Section: 5

Standards

- CSA C22.2 NO. 14-10 INDUSTRIAL CONTROL EQUIPMENT - Edition 12
- UL 508 STANDARD FOR INDUSTRIAL CONTROL EQUIPMENT - Edition 17

Ratings

Parameter	Symbol	Unit	Value
Max surrounding air temperature	T_A	°C	105
Primary current	I_P	A	According to series primary current
Secondary supply voltage	U_C	V DC	5
Output voltage	U_{out}	V	0 to 5

Conditions of acceptability

- 1 - These devices have been evaluated for overvoltage category III and for use in pollution degree 2 environment.
- 2 - A suitable enclosure shall be provided in the end-use application.
- 3 - The terminals have not been evaluated for field wiring.
- 4 - These devices are intended to be mounted on a printed wiring board of end use equipment. The suitability of the connections (including spacings) shall be determined in the end-use application.
- 5 - Primary terminals shall not be straightened since assembly of housing case depends upon bending of the terminals.
- 6 - Any surface of polymeric housing have not been evaluated as insulating barrier.
- 7 - Low voltage control circuit shall be supplied by an isolating source (such as a transformer, optical isolator, limiting impedance or electro-mechanical relay).

Marking

Only those products bearing the UR Mark should be considered to be Listed or Recognized and covered under UL's Follow-Up Service. Always look for the Mark on the product.

Insulation coordination

Parameter	Symbol	Unit	Value	Comment
RMS voltage for AC insulation test, 50 Hz, 1 min	U_d	kV	4.3	
Impulse withstand voltage 1.2/50 μ s	U_{Ni}	kV	8	
Clearance (pri. - sec.)	d_{Cl}	mm	> 8	Shortest distance through air
Creepage distance (pri. - sec.)	d_{Cp}	mm	> 8	Shortest path along device body
Clearance (pri. - sec.)	-	mm	8	When mounted on PCB with recommended layout
Case material	-	-	V0	According to UL 94
Comparative tracking index	CTI		600	
Application example	-	V	600	Reinforced insulation, according to IEC 61800-5-1, CAT III PD2
Application example	-	V	1000	Basic insulation, according to IEC 61800-5-1, CAT III PD2

Environmental and mechanical characteristics

Parameter	Symbol	Unit	Min	Typ	Max	Comment
Ambient operating temperature	T_A	°C	-40		105	
Ambient storage temperature	T_S	°C	-40		105	
Mass	m	g		5		

Electrical data HLSR 16-PW

 At $T_A = 25\text{ °C}$, $U_C = +5\text{ V}$ unless otherwise noted (see Min, Max, typ. definition paragraph in page 13).

Parameter	Symbol	Unit	Min	Typ	Max	Comment
Primary nominal RMS current	I_{PN}	A		16		
Primary current, measuring range	I_{PM}	A	-40		40	
Number of primary turns	N_P	-		1		
Resistance of primary jumper @ $T_A = 25\text{ °C}$	R_P	mΩ		0.21		
Resistance of primary jumper @ $T_A = 105\text{ °C}$	R_P	mΩ		0.29		$T_{\text{jumper}} = 120\text{ °C}$
Supply voltage ¹⁾	U_C	V	4.5	5	5.5	
Current consumption	I_C	mA		24	31	Unloaded and output mode = 0 ²⁾
Density of ones @ $I_P = 0\text{ A}$	D_{out}	%		50		
Density of ones @ $\pm I_{PN}$	D_{out}	%		50 ± 16		
Density of ones @ $\pm I_{PM}$	D_{out}	%		50 ± 40		Over operating temperature range
Load capacitance	C_L	nF	0		30	
Electrical offset for PDM output referred to primary (@ $I_P = 0\text{ A}$)	D_{OE}	%	-0.1		0.1	Relative to $D_{out} = 50\%$
Electrical offset current referred to primary	I_{OE}	mA	-100		100	
Temperature coefficient of I_{OE}	TCI_{OE}	mA/K	-1.4		1.4	-40 °C ... 105 °C
Nominal sensitivity	S_N	%/A		1		16 % @ I_{PN}
Sensitivity error	ε_S	%	-0.5		0.5	Factory adjustment
Temperature coefficient of S	TCS	ppm/K	-250		250	-40 °C ... 105 °C
Linearity error 0 ... I_{PN}	ε_L	% of I_{PN}	-0.5		0.5	
Linearity error 0 ... I_{PM}	ε_L	% of I_{PM}	-0.5		0.5	
Magnetic offset current (@ $10 \times I_{PN}$) referred to primary	I_{OM}	A	-0.25		0.25	
Delay time @ 90 % of I_{PN}	t_{D90}	μs				Determined by digital filter and OSR ³⁾
Sum of sensitivity and linearity @ I_{PN}	ε_{SL}	% of I_{PN}	-1		1	
Sum of sensitivity and linearity @ I_{PN} @ $T_A = +85\text{ °C}$	ε_{SL}	% of I_{PN}	-3		3	See formula note ⁴⁾
Sum of sensitivity and linearity @ I_{PN} @ $T_A = +105\text{ °C}$	ε_{SL}	% of I_{PN}	-3.7		3.7	See formula note ⁴⁾

Notes: ¹⁾ 3.3 V SP version available

²⁾ See page 10

³⁾ See page 12

$$\varepsilon_{SL}(T_A) = \varepsilon_{SL25} + \left(TCS + \frac{TCI_{OE}}{I_{PN}} \right) \times |T_A - 25|$$

Electrical data HLSR 32-PW

 At $T_A = 25\text{ °C}$, $U_C = +5\text{ V}$, unless otherwise noted (see Min, Max, typ. definition paragraph in page 13).

Parameter	Symbol	Unit	Min	Typ	Max	Comment
Primary nominal RMS current	I_{PN}	A		32		
Primary current, measuring range	I_{PM}	A	-80		80	
Number of primary turns	N_P	-		1		
Resistance of primary jumper @ $T_A = 25\text{ °C}$	R_P	mΩ		0.21		
Resistance of primary jumper @ $T_A = 105\text{ °C}$	R_P	mΩ		0.29		T jumper = 120 °C
Supply voltage ¹⁾	U_C	V	4.5	5	5.5	
Current consumption	I_C	mA		24	31	Unloaded and output mode = 0 ²⁾
Density of ones @ $I_P = 0\text{ A}$	D_{out}	%		50		
Density of ones @ $\pm I_{PN}$	D_{out}	%		50 ±16		
Density of ones @ $\pm I_{PM}$	D_{out}	%		50 ±40		Over operating temperature range
Load capacitance	C_L	nF	0		30	
Electrical offset for PDM output referred to primary (@ $I_P = 0\text{ A}$)	D_{OE}	%	-0.1		0.1	Relative to $D_{out} = 50\%$
Electrical offset current referred to primary	I_{OE}	mA	-200		200	
Temperature coefficient of I_{OE}	TCI_{OE}	mA/K	-2.8		2.8	-40 °C ... 105 °C
Nominal sensitivity	S_N	%/A		0.5		16 % @ I_{PN}
Sensitivity error	ε_S	%	-0.5		0.5	Factory adjustment
Temperature coefficient of S	TCS	ppm/K	-250		250	-40 °C ... 105 °C
Linearity error 0 ... I_{PN}	ε_L	% of I_{PN}	-0.5		0.5	
Linearity error 0 ... I_{PM}	ε_L	% of I_{PM}	-0.5		0.5	
Magnetic offset current (@ $10 \times I_{PN}$) referred to primary	I_{OM}	A	-0.25		0.25	
Delay time @ 90 % of I_{PN}	t_{D90}	μs				Determined by digital filter and OSR ³⁾
Sum of sensitivity and linearity @ I_{PN}	ε_{SL}	% of I_{PN}	-1		1	
Sum of sensitivity and linearity @ I_{PN} @ $T_A = +85\text{ °C}$	ε_{SL}	% of I_{PN}	-3		3	See formula note ⁴⁾
Sum of sensitivity and linearity @ I_{PN} @ $T_A = +105\text{ °C}$	ε_{SL}	% of I_{PN}	-3.7		3.7	See formula note ⁴⁾

Notes: ¹⁾ 3.3 V SP version available

²⁾ See page 10

³⁾ See page 12

⁴⁾

$$\varepsilon_{SL}(T_A) = \varepsilon_{SL25} + \left(TCS + \frac{TCI_{OE}}{I_{PN}} \right) \times |T_A - 25|$$

Electrical data HLSR 40-PW

 At $T_A = 25\text{ °C}$, $U_C = +5\text{ V}$, unless otherwise noted (see Min, Max, typ. definition paragraph in page 13).

Parameter	Symbol	Unit	Min	Typ	Max	Comment
Primary nominal RMS current	I_{PN}	A		40		
Primary current, measuring range	I_{PM}	A	-100		100	
Number of primary turns	N_P	-		1		
Resistance of primary jumper @ $T_A = 25\text{ °C}$	R_P	mΩ		0.21		
Resistance of primary jumper @ $T_A = 105\text{ °C}$	R_P	mΩ		0.29		$T_{\text{jumper}} = 120\text{ °C}$
Supply voltage ¹⁾	U_C	V	4.5	5	5.5	
Current consumption	I_C	mA		24	31	Unloaded and output mode = 0 ²⁾
Density of ones @ $I_P = 0\text{ A}$	D_{out}	%		50		
Density of ones @ $\pm I_{PN}$	D_{out}	%		50 ±16		
Density of ones @ $\pm I_{PM}$	D_{out}	%		50 ±40		Over operating temperature range
Load capacitance	C_L	nF	0		30	
Electrical offset for PDM output referred to primary (@ $I_P = 0\text{ A}$)	D_{OE}	%	-0.1		0.1	Relative to $D_{out} = 50\%$
Electrical offset current referred to primary	I_{OE}	mA	-250		250	
Temperature coefficient of I_{OE}	TCI_{OE}	mA/K	-3.5		3.5	-40 °C ... 105 °C
Nominal sensitivity	S_N	%/A		0.4		16 % @ I_{PN}
Sensitivity error	ε_S	%	-0.5		0.5	Factory adjustment
Temperature coefficient of S	TCS	ppm/K	-250		250	-40 °C ... 105 °C
Linearity error 0 ... I_{PN}	ε_L	% of I_{PN}	-0.5		0.5	
Linearity error 0 ... I_{PM}	ε_L	% of I_{PM}	-0.5		0.5	
Magnetic offset current (@ $10 \times I_{PN}$) referred to primary	I_{OM}	A	-0.25		0.25	
Delay time @ 90 % of I_{PN}	t_{D90}	μs				Determined by digital filter and OSR ³⁾
Sum of sensitivity and linearity @ I_{PN}	ε_{SL}	% of I_{PN}	-1		1	
Sum of sensitivity and linearity @ I_{PN} @ $T_A = +85\text{ °C}$	ε_{SL}	% of I_{PN}	-3		3	See formula note ⁴⁾
Sum of sensitivity and linearity @ I_{PN} @ $T_A = +105\text{ °C}$	ε_{SL}	% of I_{PN}	-3.7		3.7	See formula note ⁴⁾

Notes: ¹⁾ 3.3 V SP version available

²⁾ See page 10

³⁾ See page 12

⁴⁾
$$\varepsilon_{SL}(T_A) = \varepsilon_{SL25} + \left(TCS + \frac{TCI_{OE}}{I_{PN}} \right) \times |T_A - 25|$$

Electrical data HLSR 50-PW

 At $T_A = 25\text{ °C}$, $U_C = +5\text{ V}$, unless otherwise noted (see Min, Max, typ. definition paragraph in page 13).

Parameter	Symbol	Unit	Min	Typ	Max	Comment
Primary nominal RMS current	I_{PN}	A		50		
Primary current, measuring range	I_{PM}	A	-125		125	
Number of primary turns	N_P	-		1		
Resistance of primary jumper @ $T_A = 25\text{ °C}$	R_P	m Ω		0.21		
Resistance of primary jumper @ $T_A = 105\text{ °C}$	R_P	m Ω		0.29		$T_{\text{jumper}} = 120\text{ °C}$
Supply voltage ¹⁾	U_C	V	4.5	5	5.5	
Current consumption	I_C	mA		24	31	Unloaded and output mode = 0 ²⁾
Density of ones @ $I_P = 0\text{ A}$	D_{out}	%		50		
Density of ones @ $\pm I_{PN}$	D_{out}	%		50 \pm 16		
Density of ones @ $\pm I_{PM}$	D_{out}	%		50 \pm 40		Over operating temperature range
Load capacitance	C_L	nF	0		30	
Electrical offset for PDM output referred to primary (@ $I_P = 0\text{ A}$)	D_{OE}	%	-0.1		0.1	Relative to $D_{out} = 50\%$
Electrical offset current referred to primary	I_{OE}	mA	-313		313	
Temperature coefficient of I_{OE}	TCI_{OE}	mA/K	-4.38		4.38	-40 °C ... 105 °C
Nominal sensitivity	S_N	%/A		0.32		16 % @ I_{PN}
Sensitivity error	ϵ_S	%	-0.5		0.5	Factory adjustment
Temperature coefficient of S	TCS	ppm/K	-250		250	-40 °C ... 105 °C
Linearity error 0 ... I_{PN}	ϵ_L	% of I_{PN}	-0.5		0.5	
Linearity error 0 ... I_{PM}	ϵ_L	% of I_{PM}	-0.5		0.5	
Magnetic offset current (@ $10 \times I_{PN}$) referred to primary	I_{OM}	A	-0.25		0.25	
Delay time @ 90 % of I_{PN}	t_{D90}	μ s				Determined by digital filter and OSR ³⁾
Sum of sensitivity and linearity @ I_{PN}	ϵ_{SL}	% of I_{PN}	-1		1	
Sum of sensitivity and linearity @ I_{PN} @ $T_A = +85\text{ °C}$	ϵ_{SL}	% of I_{PN}	-3		3	See formula note ⁴⁾
Sum of sensitivity and linearity @ I_{PN} @ $T_A = +105\text{ °C}$	ϵ_{SL}	% of I_{PN}	-3.7		3.7	See formula note ⁴⁾

Notes: ¹⁾ 3.3 V SP version available

²⁾ See page 10

³⁾ See page 12

$$^4) \epsilon_{SL}(T_A) = \epsilon_{SL25} + \left(TCS + \frac{TCI_{OE}}{I_{PN}} \right) \times |T_A - 25|$$

HLSR-PW series output characteristics

Mode 0 and 8: 2 Wire CMOS

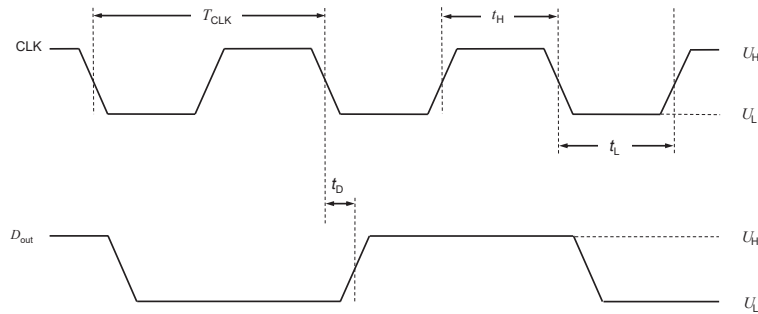

For all allowed capacitive range

- Timing for mode 0

Parameter	Symbol	Unit	Min	Typ	Max	Comment
Temperature coefficient of clock period	TCT_{CLK}	ppm/K	-400	0	400	-40 °C ... 105 °C
Clock high time	t_H	ns	$0.45 \times T_{CLK}$	46.75	$0.55 \times T_{CLK}$	
Clock falling edge to data delay	t_D	ns	-25	0	25	

- Timing for mode 8

Parameter	Symbol	Unit	Min	Typ	Max	Comment
Clock high time	t_H	ns	$0.45 \times T_{CLK}$	$0.5 \times T_{CLK}$	$0.55 \times T_{CLK}$	
Clock falling edge to data delay	t_D	ns	13	0	49	

In mode 8, you can use external clock from 5 to 10.1 MHz or from 11.4 to 12.5 MHz.

- Levels

Parameter	Symbol	Unit	Min	Typ	Max	Comment
Low voltage	U_L	V			0.4	with $I_{out L} = 4$ mA, unloaded
High voltage	U_H	V	$U_C - 0.4$			with $I_{out H} = -4$ mA, unloaded

Mode 1: 2 Wire RS 422 Manchester (ANSI/TIA/EIA-422-B and IEEE 802.3)

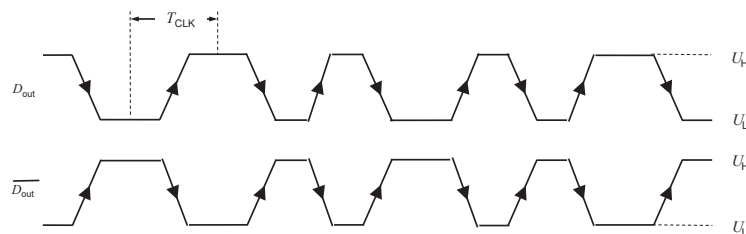

For all allowed capacitive range, R_L can be 100 Ohm.

Logical 1 is coding on a rising edge on D_{out} .

- Timing for mode 1

Parameter	Symbol	Unit	Min	Typ	Max	Comment
Temperature coefficient of clock period	TCT_{CLK}	ppm/K	-400	0	400	-40 °C ... 105 °C

- Levels

Parameter	Symbol	Unit	Min	Typ	Max	Comment
Low voltage	U_L	V			0.4	with $I_{out L} = 4$ mA, unloaded
High voltage	U_H	V	$U_C - 0.4$			with $I_{out H} = -4$ mA, unloaded

Mode 3: 2 Wire LVDS Manchester (ANSI/TIA/EIA-644-A and IEEE 802.3)

For all allowed capacitive range, recommended load resistor $R_L = 100$ Ohm.

Logical 1 is coding on a rising edge on D_{out} .

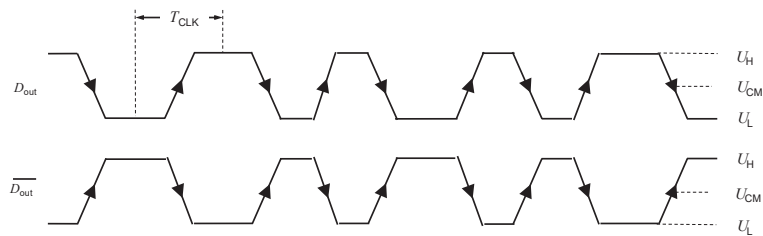

- Timing for mode 3

Parameter	Symbol	Unit	Min	Typ	Max	Comment
Clock period	T_{CLK}	ns	89	93.5	98	$f_{CLK} = 10.7$ MHz ± 5 %
Temperature coefficient of clock period	TCT_{CLK}	ppm/K	-400	0	400	-40 °C ... 105 °C

- Levels

Parameter	Symbol	Unit	Min	Typ	Max	Comment
Low voltage	U_L	mV		$(-3.5 \times R_L) / 2$		Relative to U_{CM}
High voltage	U_H	mV		$(3.5 \times R_L) / 2$		Relative to U_{CM}
Common mode voltage	$U_{clk CM}$	V		1.25		

HLSR-PW series output characteristics

Modulator output: Density of ones versus % of I_{PN}

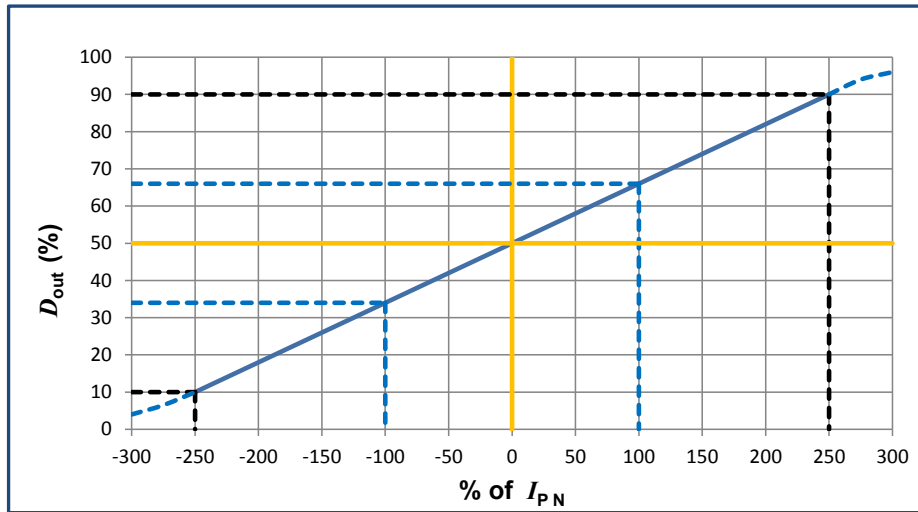

Maximum continuous DC current

For all ranges:

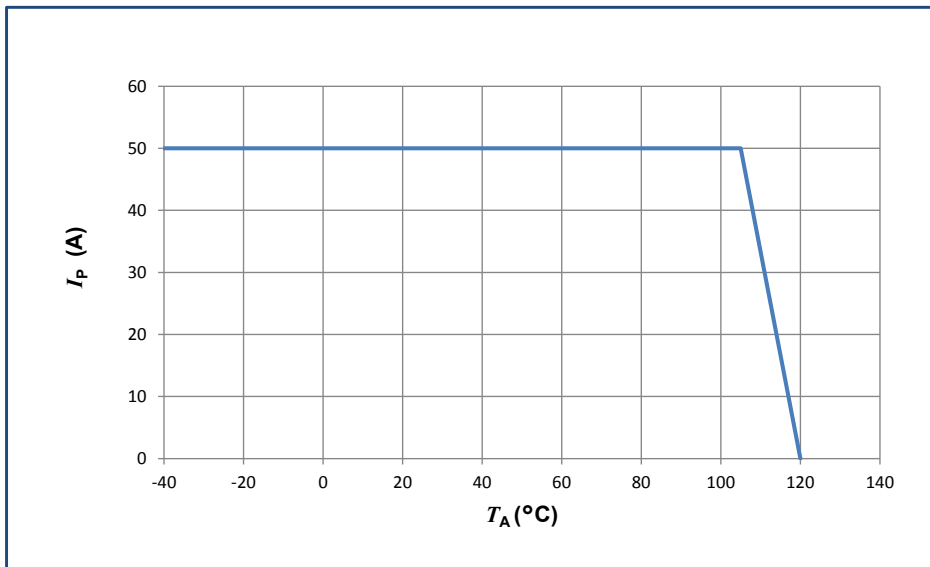

Important notice: whatever the usage and/or application, the transducer primary bar / jumper temperature shall not go above the maximum rating of 120 °C as stated in page 2 of this datasheet.

Consumption

Typical values with $C_L = 5$ pF

Output Mode	I_C unloaded (mA)	I_C with $R_L = 100$ Ohm (mA)
0	24	-
1	24	53
3	-	30
8	24	-

Effective resolution versus OSR

HLSR 16-PW-xxx

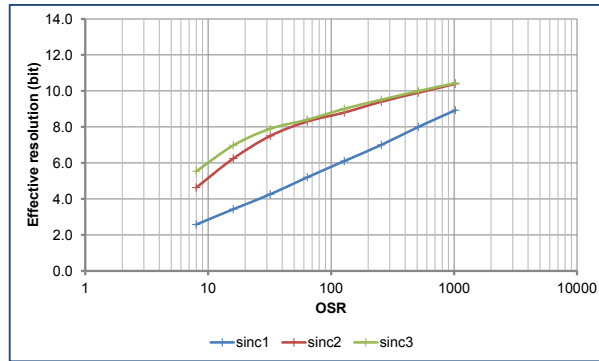

HLSR 32-PW-xxx

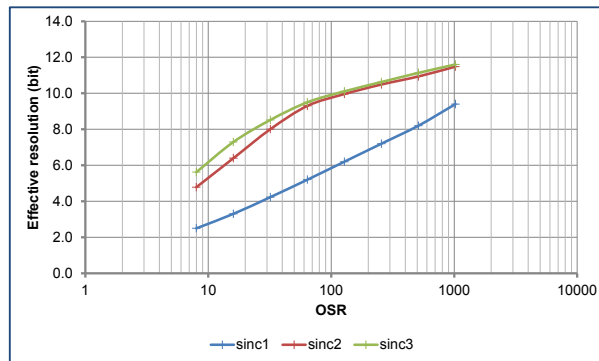

HLSR 40-PW-xxx

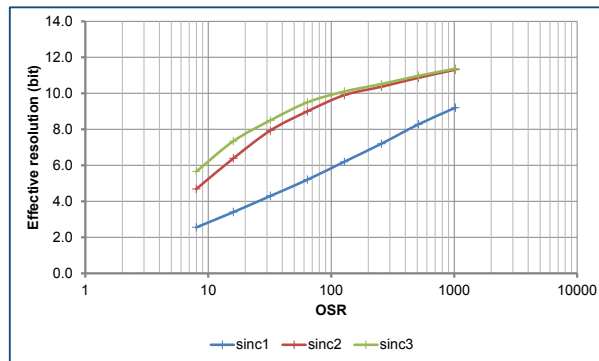

HLSR 50-PW-xxx

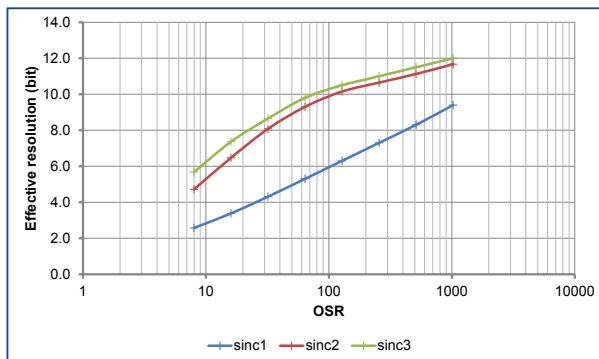

Signal to noise ratio

$$SNR (dB) = 20 \cdot \log_{10} (2) / \text{Effective resolution}$$

Delay time versus OSR

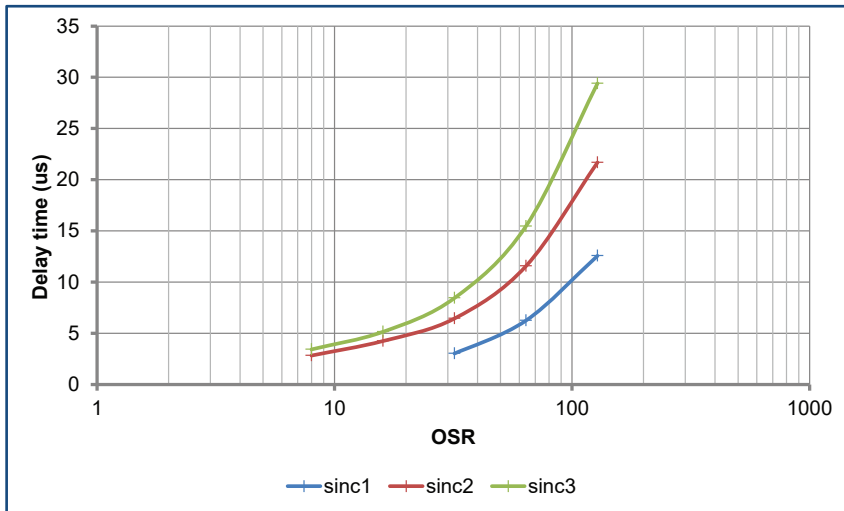

Bandwidth (-3 dB) versus OSR

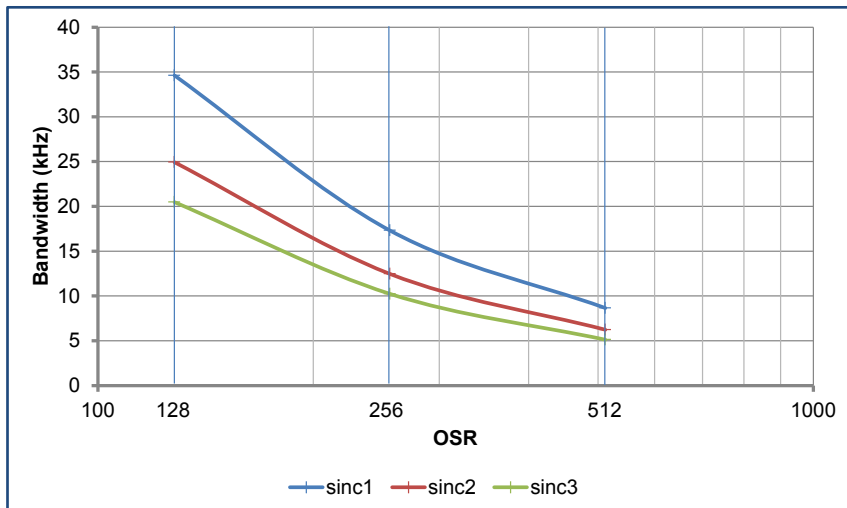

Theoretical values due to customer filter configuration

HLSR-PW series: name and codification

HLSR-PW family products may be ordered **on request** ¹⁾ with a dedicated setting of the parameters as described below (standards products are delivered with the setting 000 according to the table).

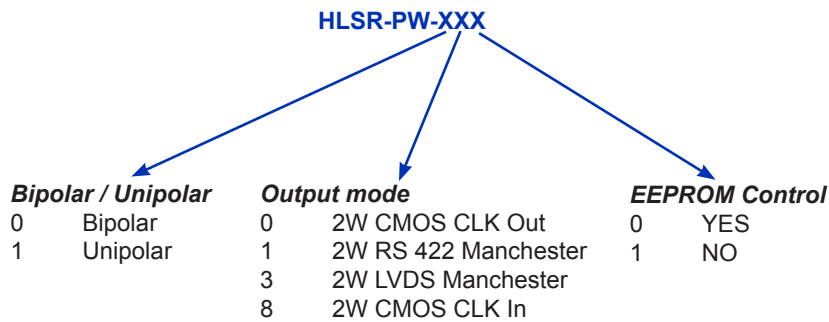

Standards products are:

- HLSR 16-PW-000
- HLSR 32-PW-000
- HLSR 40-PW-000
- HLSR 50-PW-000

Note: ¹⁾For dedicated settings, minimum quantities apply, please contact your local LEM support.

Definition of typical, minimum and maximum values

Minimum and maximum values for specified limiting and safety conditions have to be understood as such as well as values shown in “typical” graphs. On the other hand, measured values are part of a statistical distribution that can be specified by an interval with upper and lower limits and a probability for measured values to lie within this interval. Unless otherwise stated (e.g. “100 % tested”), the LEM definition for such intervals designated with “min” and “max” is that the probability for values of samples to lie in this interval is 99.73 %. For a normal (Gaussian) distribution, this corresponds to an interval between -3σ and $+3\sigma$. If “typical” values are not obviously mean or average values, those values are defined to delimit intervals with a probability of 68.27 %, corresponding to an interval between $-\sigma$ and $+\sigma$ for a normal distribution. Typical, minimum and maximum values are determined during the initial characterization of the product.

Remark

Installation of the transducer must be done unless otherwise specified on the datasheet, according to LEM Transducer Generic Mounting Rules. Please refer to LEM document N°ANE120504 available on our Web site: <https://www.lem.com/en/file/3137/download>

Safety

This transducer must be used in limited-energy secondary circuits according to IEC 61010-1.



This transducer must be used in electric/electronic equipment with respect to applicable standards and safety requirements in accordance with the manufacturer’s operating instructions.



Caution, risk of electrical shock

When operating the transducer, certain parts of the module can carry hazardous voltage (eg. primary busbar, power supply). Ignoring this warning can lead to injury and/or cause serious damage. This transducer is a build-in device, whose conducting parts must be inaccessible after installation. A protective housing or additional shield could be used. Main supply must be able to be disconnected.

Although LEM applies utmost care to facilitate compliance of end products with applicable regulations during LEM product design, use of this part may need additional measures on the application side for compliance with regulations regarding EMC and protection against electric shock. Therefore LEM cannot be held liable for any potential hazards, damages, injuries or loss of life resulting from the use of this product.

PCB footprint (in mm)

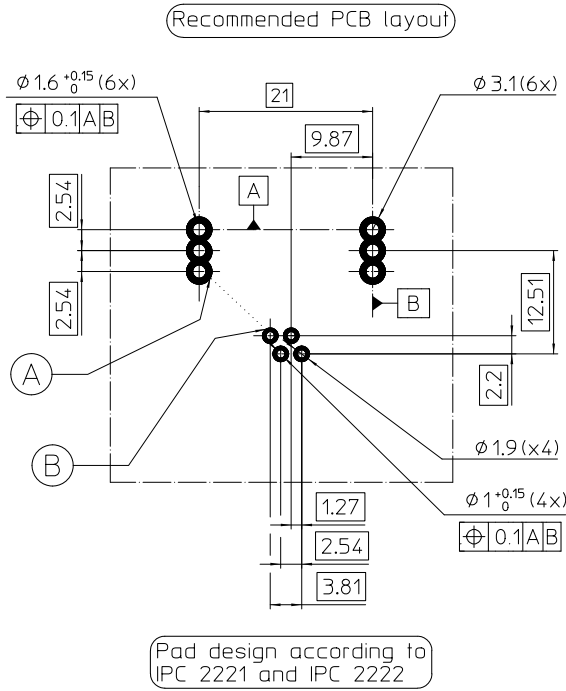

	d_{Cl} (mm)	d_{Cp} (mm)
A-B	9.42	9.42

Assembly on PCB

- Recommended PCB hole diameter 1.6 mm for primary pins
1 mm for secondary pins
- Maximum PCB thickness 2.4 mm
- Wave soldering profile maximum 260 °C for 10 s
No clean process only.

Dimensions (in mm. General linear tolerance ± 0.2 mm)

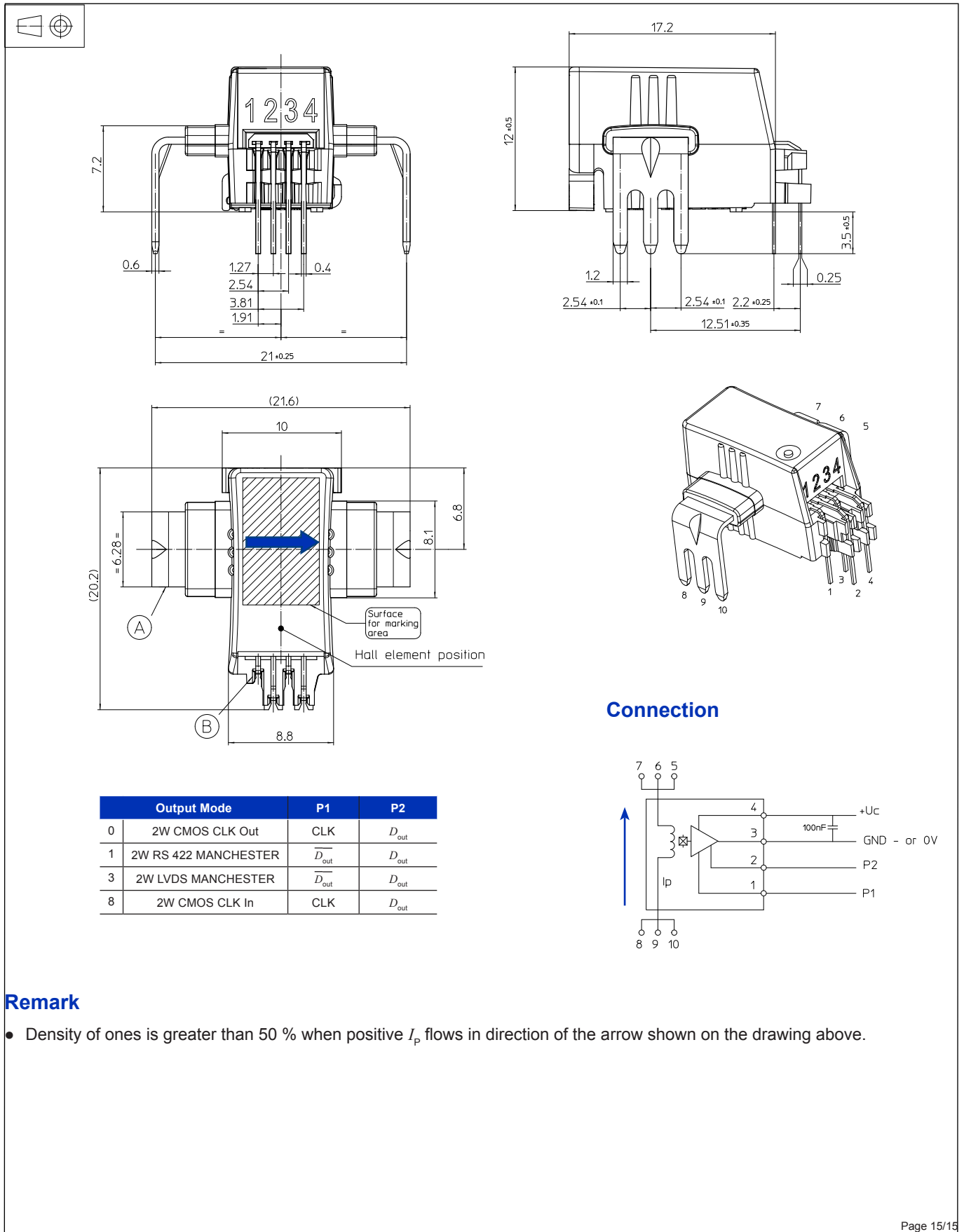

Remark

- Density of ones is greater than 50 % when positive I_p flows in direction of the arrow shown on the drawing above.

单击下面可查看定价，库存，交付和生命周期等信息

[>>LEM\(莱姆\)](#)