

For the electronic measurement of current: DC, AC, pulsed..., with galvanic separation between the primary and the secondary circuit.

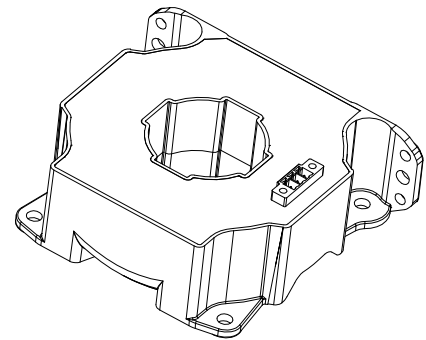

Features

- Bipolar and insulated current measurement
- Current output
- Closed loop (compensated) current transducer
- Panel mounting.

Special feature

- Connection to secondary circuit on Phoenix connector with 3 tin plated pins, 3.81 mm pitch.

Advantages

- High accuracy
- Very low offset drift over temperature.

Applications

- Windmill inverters
- Test measurement
- Substations
- AC variable speed and servo motor drives
- Static converters for DC motor drives
- Battery supplied applications
- Uninterruptible Power Supplies (UPS)
- Switched Mode Power Supplies (SMPS)
- Power supplies for welding applications.

Standards

- IEC 61800-5-1: 2007
- IEC 62109-1: 2010
- IEC 61010-1: 2010
- IEC 61800-1: 2004
- IEC 61800-2: 2015
- IEC 61800-3: 2011
- UL 508 : 2013.

Application Domain

- Industrial.

Absolute maximum ratings

Parameter	Symbol	Unit	Value
Maximum supply voltage (working) (-40 ... 85 °C)	$\pm U_{C \max}$	V	±25.2
Maximum primary conductor temperature	$T_{B \max}$	°C	100
Maximum steady state primary nominal current (-40 ... 85 °C)	$I_{P N \max}$	A	1000

Stresses above these ratings may cause permanent damage.
Exposure to absolute maximum ratings for extended periods may degrade reliability.

UL 508: Ratings and assumptions of certification

File # E189713 Volume: 2 Section: 9

Standards

- USR indicates investigation to the Standard for Industrial Control Equipment UL 508, Edition 17.
- CNR indicates investigation to the Canadian standard for Industrial Control Equipment CSA C22.2 No. 14-13, Edition 11.

Ratings

Parameter	Unit	Value
Primary involved potential	V AC/DC	1500
Ambient operating temperature	°C	85
Primary current	A	1000
Secondary supply voltage	V DC	0 ... ±25.2
Secondary current	mA	0 ... 200

Conditions of acceptability

When installed in the end-use equipment, with primary feedthrough potential involved of 1500 V AC/DC, consideration shall be given to the following:

- 1 - These products must be mounted in a suitable end-use enclosure.
- 2 - The secondary pin terminals have not been evaluated for field wiring.
- 3 - Low voltage control circuit shall be supplied by an isolating source (such as transformer, optical isolator, limiting impedance or electro-mechanical relay).
- 4 - Based on the temperature test performed on all Series, the primary bar or conductor shall not exceed 100 °C in the end use application.
- 5 - LF 1010-S series shall be used in a pollution degree 2.

Marking

Only those products bearing the UL or UR Mark should be considered to be Listed or Recognized and covered under UL's Follow-Up Service. Always look for the Mark on the product.

Insulation coordination

Parameter	Symbol	Unit	Value	Comment
RMS voltage for AC insulation test, 50 Hz, 1 min	U_d	kV	6	
Impulse withstand voltage 1.2/50 μ s	U_{Ni}	kV	12.5	According to IEC 61800-5-1
Partial discharge RMS test voltage ($q_m < 10$ pC)	U_t	kV	1.65	Test carried out with a non insulated bar and completely filling the primary hole. According to IEC 61800-5-1
Insulation resistance	R_{INS}	M Ω	200	Measured at 500 V DC
Clearance (pri. - sec.)	d_{Cl}	mm	17.6	Shortest distance through air
Creepage distance (pri. - sec.)	d_{Cp}	mm	27.6	Shortest path along device body
Application example Rated insulation RMS voltage	U_{Nm}	V	1000	Basic insulation according to IEC 61800-5-1 CAT III, PD2 (table value)
Application example Rated insulation RMS voltage	U_{Nm}	V	1000	Reinforced insulation according to IEC 61800-5-1 CAT III, PD2 (table value)
Case material	-	-	V0	According to UL 94
Comparative tracking index	CTI		600	

Environmental and mechanical characteristics

Parameter	Symbol	Unit	Min	Typ	Max	Comment
Ambient operating temperature	T_A	$^{\circ}$ C	-40		85	
Ambient storage temperature	T_S	$^{\circ}$ C	-50		90	
Mass	m	g		435		

Electrical data

At $T_A = 25\text{ °C}$, $\pm U_C = \pm 24\text{ V}$, $R_M = 1\ \Omega$, unless otherwise noted.

Lines with a * in the conditions column apply over the $-40 \dots 85\text{ °C}$ ambient temperature range.

Parameter	Symbol	Unit	Min	Typ	Max	Conditions
Primary nominal DC current (continuous)	$I_{P\text{NDC}}$	A			1000	*
Primary current, measuring range	I_{PM}	A	-2720		2720	* With $\pm U_C = \pm 22.8\text{ V}$; $T_A = 85\text{ °C}$; $R_M = 1\ \Omega$ For other conditions, see figure 1
Measuring resistance	R_M	Ω	0			* Max value of R_M is given in figure 1
Secondary nominal RMS current	I_{SN}	A			0.2	*
Resistance of secondary winding	R_S	Ω			29.9	$R_S(T_A) = R_S \times (1 + 0.004 \times (T_A + \Delta\text{temp} - 25))$ Estimated temperature increase @ I_{PN} is $\Delta\text{temp} = 15\text{ °C}$
Secondary current	I_S	A	-0.544		0.544	*
Number of secondary turns	N_S			5000		
Nominal sensitivity	S_N	mA/A		0.2		
Supply voltage	$\pm U_C$	V	± 14.25		± 25.2	*
Current consumption @ $I_{PN} = 0$	I_C	mA		44 49		$\pm U_C = \pm 15\text{ V}$ $\pm U_C = \pm 24\text{ V}$
Offset current referred to primary	I_O	A	-1		1	
Temperature variation of I_O referred to primary	I_{OT}	A	-0.6		0.6	*
Magnetic offset current after $3 \times I_{PN}$ referred to primary	I_{OM}	A		± 1		
Sensitivity error	ε_S	%	-0.15		0.15	*
Linearity error	ε_L	% of I_{PN}	-0.15		0.15	*
Total error at I_{PN}	ε_{tot}	% of I_{PN}	-0.2 -0.4		0.2 0.4	* 25 ... 70 ... 85 °C -40 ... 85 °C
RMS noise current referred to primary	I_{no}	mA		50		1 Hz to 20 kHz (see figure 4)
Delay time @ 10 % of I_{PN}	t_{D10}	μs		< 0.5		0 to 1 kA, 200 A/ μs
Delay time to 90 % of I_{PN}	t_{D90}	μs		< 0.5		0 to 1 kA, 200 A/ μs
Frequency bandwidth	BW	kHz		200		-3 dB, small signal bandwidth (see figure 5)

Definition of typical, minimum and maximum values

Minimum and maximum values for specified limiting and safety conditions have to be understood as such as well as values shown in "typical" graphs.

On the other hand, measured values are part of a statistical distribution that can be specified by an interval with upper and lower limits and a probability for measured values to lie within this interval.

Unless otherwise stated (e.g. "100 % tested"), the LEM definition for such intervals designated with "min" and "max" is that the probability for values of samples to lie in this interval is 99.73 %.

For a normal (Gaussian) distribution, this corresponds to an interval between -3 sigma and +3 sigma. If "typical" values are not obviously mean or average values, those values are defined to delimit intervals with a probability of 68.27 %, corresponding to an interval between -sigma and +sigma for a normal distribution.

Typical, maximal and minimal values are determined during the initial characterization of the product.

Typical performance characteristics

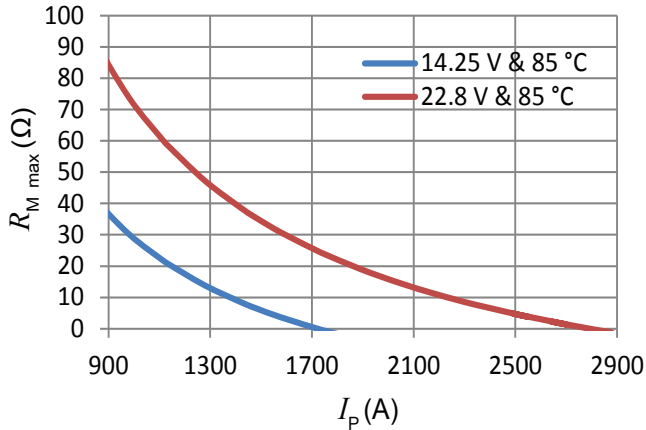

Figure 1: Maximum measuring resistance

$$R_{M \max} = N_s \times \frac{U_{C \min} - 0.5 \text{ V}}{I_p} - R_{S \max} - 0.93 \Omega$$

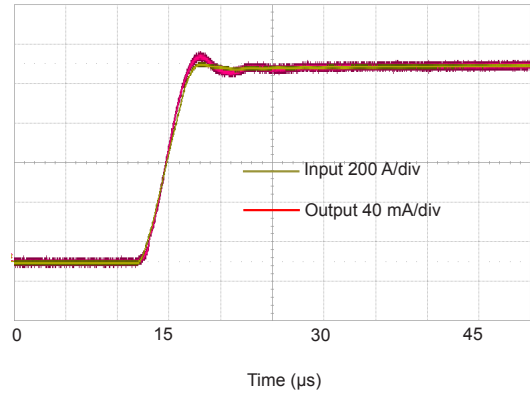

Figure 2: Typical step response (0 to 1 kA, 200 A/μs)

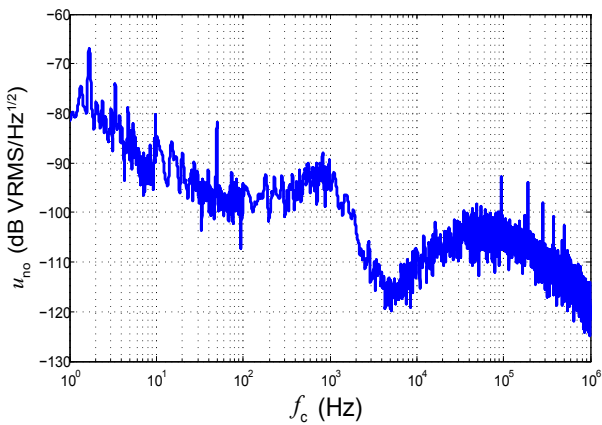

Figure 3: Noise voltage spectral density referred to primary u_{no} with $R_M = 100 \Omega$

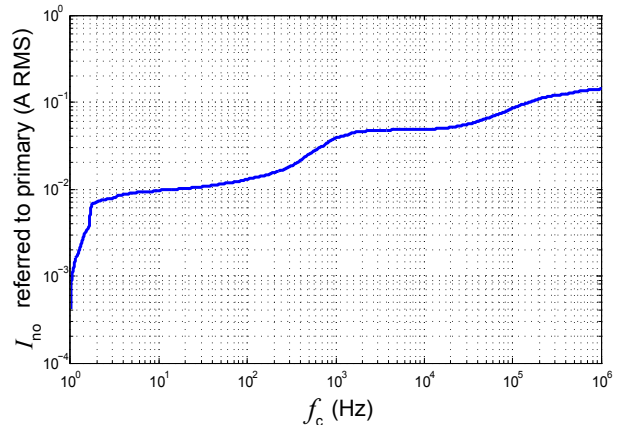

Figure 4: RMS noise current referred to primary I_{no} with $R_M = 100 \Omega$

To calculate the noise in a frequency band f_1 to f_2 , the formula is:

$$I_{no}(f_1 \text{ to } f_2) = \sqrt{I_{no}(f_2)^2 - I_{no}(f_1)^2}$$

with $I_{no}(f)$ read from figure 4 (typical, RMS value).

Example:

What is the noise from 1 to 10^6 Hz?

Figure 4 gives $I_{no}(1 \text{ Hz}) = 0.5 \text{ mA}$ and $I_{no}(10^6 \text{ Hz}) = 199 \text{ mA}$.

The output RMS noise current is therefore:

$$\sqrt{(199 \times 10^{-3})^2 - (0.5 \times 10^{-3})^2} = 199 \text{ mA referred to primary}$$

Typical performance characteristics continued

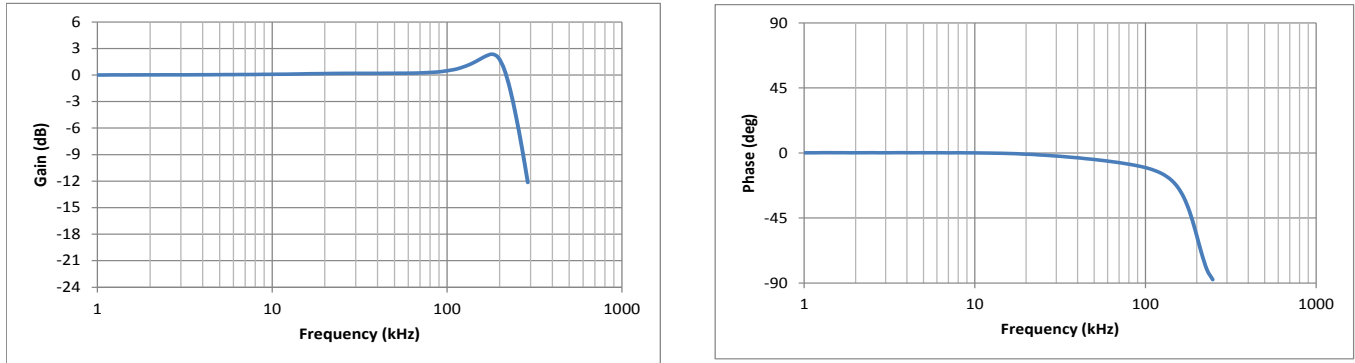

Figure 5: Typical frequency response, small signal bandwidth

Performance parameters definition

Sensitivity and linearity

To measure sensitivity and linearity, the primary current (DC) is cycled from 0 to I_{PM} , then to $-I_{PM}$ and back to 0 (equally spaced $I_{PM}/10$ steps). The sensitivity S is defined as the slope of the linear regression line for a cycle between $\pm I_{PM}$. The linearity error ϵ_L is the maximum positive or negative difference between the measured points and the linear regression line, expressed in % of the maximum measured value.

Magnetic offset

The magnetic offset I_{OM} is the change of offset after a given current has been applied to the input. It is included in the linearity error as long as the transducer remains in its measuring range.

Electrical offset

The electrical offset current I_{OE} is the residual output current when the input current is zero.

Total error

The total error ϵ_{tot} is the error at $\pm I_{PN}$, relative to the rated value I_{PM} . It includes all errors mentioned above.

Delay times

The delay time t_{D10} @ 10 % and the delay time t_{D90} @ 90 % with respect to the primary are shown in the next figure. Both slightly depend on the primary current di/dt . They are measured at nominal current.

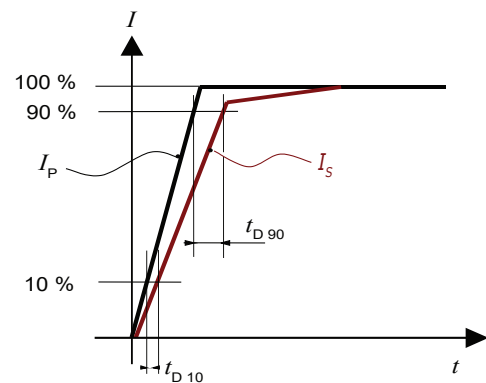
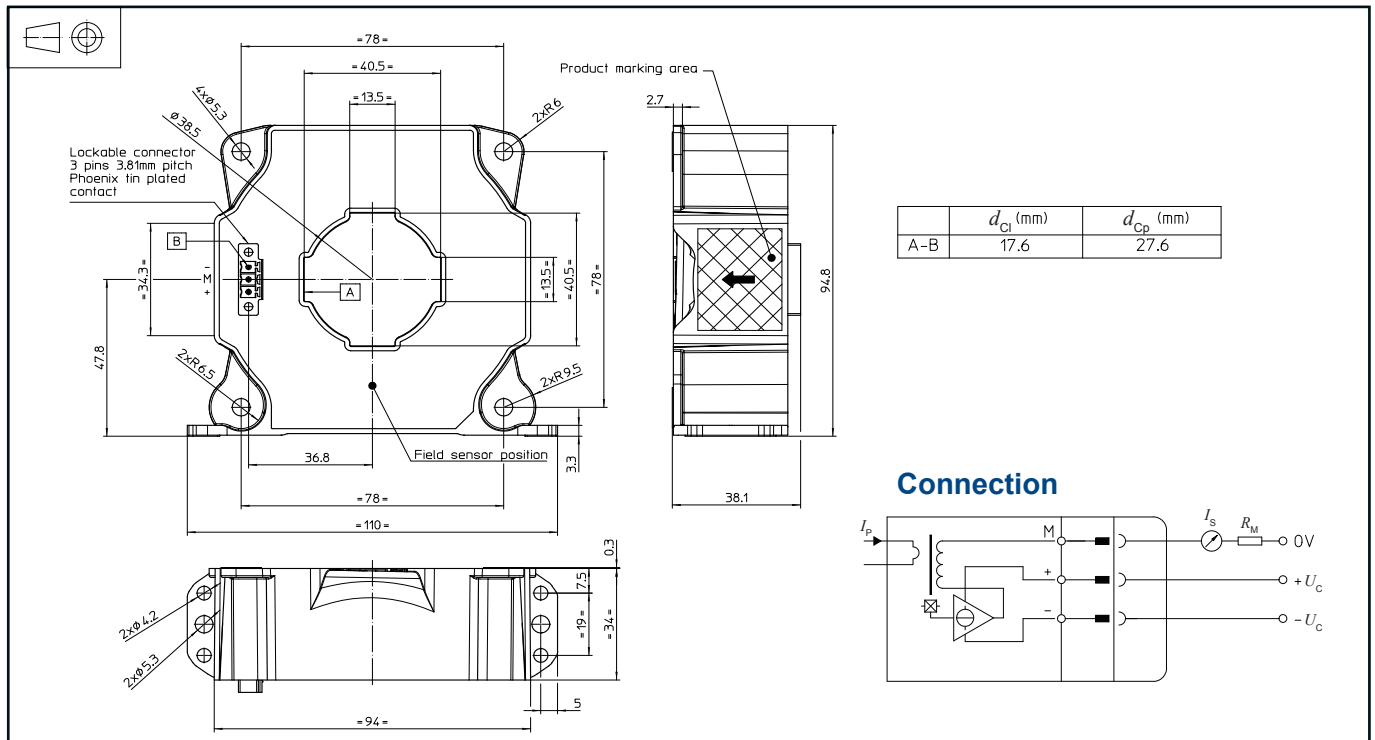

Figure 6: t_{D10} (delay time @ 10 %) and t_{D90} (delay time @ 90 %)

Dimensions (in mm)

Mechanical characteristics

- General tolerance ± 0.5 mm
- Transducer fastening
 - Vertical position
 - 2 holes $\varnothing 5.3$ mm
 - 2 M5 steel screws
 - Recommended fastening torque 3.2 N·m (± 10 %)
 - Or
 - 4 holes $\varnothing 4.2$ mm
 - 4 M4 steel screws
 - Recommended fastening torque 2.1 N·m (± 10 %)
- Primary through-hole
 - Or
 - 40 mm \times 13 mm
- Transducer fastening
 - Horizontal position
 - 4 holes $\varnothing 5.3$ mm
 - 4 M5 steel screws
 - Recommended fastening torque 3.2 N·m (± 10 %)
- Connection of secondary
 - Phoenix connector with 3 tin plated pins, 3.81 mm pitch.

Remarks

- I_s is positive when I_p flows in the direction of arrow.
- The secondary cables also have to be routed together all the way.
- Installation of the transducer is to be done without primary current or secondary voltage present.
- Maximum temperature of primary conductor: see page 2.
- Installation of the transducer must be done unless otherwise specified on the datasheet, according to LEM Transducer Generic Mounting Rules. Please refer to LEM document N°ANE120504 available on our Web site: <https://www.lem.com/en/file/3137/download>.

Safety

This transducer must be used in limited-energy secondary circuits according to IEC 61010-1.



This transducer must be used in electric/electronic equipment with respect to applicable standards and safety requirements in accordance with the manufacturer's operating instructions.



Caution, risk of electrical shock

When operating the transducer, certain parts of the module can carry hazardous voltage (e.g. primary connection, power supply). Ignoring this warning can lead to injury and/or cause serious damage. This transducer is a build-in device, whose conducting parts must be inaccessible after installation. A protective housing or additional shield could be used. Main supply must be able to be disconnected.

单击下面可查看定价，库存，交付和生命周期等信息

[>>LEM\(莱姆\)](#)