

Current Transducer HO-SW series

$I_{PN} = 100 \dots 250 \text{ A}$

Ref: HO 100-SW; HO 150-SW; HO 200-SW; HO 250-SW

Bitstream output from on onboard Sigma Delta modulator. For the electronic measurement of current: DC, AC, pulsed..., with galvanic separation between the primary and the secondary circuit.



Features

- Open loop multi-range current transducer
- Bitstream output from 2nd order Sigma-Delta modulator, (PDM) Pulse Density Modulation
- Single supply +5 V
- Overcurrent detect $2.97 \times I_{PN}$ (peak value)
- EEPROM Control
- Galvanic separation between primary and secondary circuit
- Low power consumption
- Compact design for panel mounting
- Aperture: 15 × 8 mm
- Factory calibrated
- Connection mating with HARWIN:
 - housing M30-1100800
 - contact M30-1060046
- Repositionable mounting foot
- Dedicated parameter settings available on request (see page 16).

Advantages

- Low offset drift
- Creepage / clearance 8 mm
- Fast response.

Applications

- AC variable speed and servo motor drives
- Static converters for DC motor drives
- Battery supplied applications
- Uninterruptible Power Supplies (UPS)
- Switched Mode Power Supplies (SMPS)
- Power supplies for welding applications
- Combiner box
- Solar inverter on DC side of the inverter (MPPT).

Standards

- IEC 61800-2: 2015
- IEC 61800-3: 2017
- IEC 61800-5-1: 2007
- IEC 62109-1: 2010
- UL 508: 2013.

Application Domain

- Industrial.

N° 97.P7.34.000.0; N° 97.P7.34.001.0; N° 97.P7.34.002.0; N° 97.P7.34.003.0; N° 97.P7.34.004.0 N° 97.P7.34.005.0; N° 97.P7.34.006.0; N° 97.P7.34.007.0; N° 97.P7.34.008.0; N° 97.P7.39.000.0; N° 97.P7.39.001.0; N° 97.P7.39.002.0; N° 97.P7.39.003.0; N° 97.P7.39.004.0; N° 97.P7.39.005.0 N° 97.P7.39.006.0; N° 97.P7.39.007.0; N° 97.P7.39.008.0; N° 97.P7.44.000.0; N° 97.P7.44.001.0; N° 97.P7.44.002.0; N° 97.P7.44.003.0; N° 97.P7.44.004.0; N° 97.P7.44.005.0; N° 97.P7.44.006.0; N° 97.P7.44.007.0; N° 97.P7.44.008.0; N° 97.P7.45.000.0; N° 97.P7.45.001.0; N° 97.P7.45.002.0; N° 97.P7.45.003.0; N° 97.P7.45.004.0; N° 97.P7.45.005.0; N° 97.P7.45.006.0; N° 97.P7.45.007.0; N° 97.P7.45.008.0;

Absolute maximum ratings

Parameter	Symbol	Unit	Value
Maximum supply voltage (not destructive)	$U_{C \max}$	V	8
Maximum supply voltage (not entering non standard modes)	$U_{C \max}$	V	6.5
Maximum primary conductor temperature	$T_{B \max}$	°C	120
Maximum electrostatic discharge voltage (HMB-Human Body Model)	$U_{ESD \text{ HBM}}$	kV	2

Stresses above these ratings may cause permanent damage. Exposure to absolute maximum ratings for extended periods may degrade reliability.

UL 508: Ratings and assumptions of certification

File # E189713 Volume: 2 Section: 5

Standards

- CSA C22.2 NO. 14-10 INDUSTRIAL CONTROL EQUIPMENT - Edition 12
- UL 508 STANDARD FOR INDUSTRIAL CONTROL EQUIPMENT - Edition 17

Ratings

Parameter	Symbol	Unit	Value
Primary potential involved ¹⁾		V AC/DC	600
Max surrounding air temperature	T_A	°C	105
Primary current	I_p	A	According to series primary currents
Secondary supply voltage	U_C	V DC	5
Output voltage	U_{out}	V	0 ... 5

Note: ¹⁾ Primary potential involved is 600 V AC/DC according to Canadian Standard CSA C22.2.

Conditions of acceptability

When installed in the end-use equipment, consideration shall be given to the following:

- 1 - These devices have been evaluated for overvoltage category III and for use in pollution degree 2 environment.
- 2 - A suitable enclosure shall be provided in the end-use application.
- 3 - The terminals have not been evaluated for field wiring.
- 4 - These devices have been evaluated for use in 105 °C maximum surrounding air temperature.
- 5 - The secondary (Sensing) circuit is intended to be supplied by an Isolated Secondary Circuit - Limited voltage circuit defined by UL 508 paragraph 32.5. The maximum open circuit voltage potential available to the circuit and overcurrent protection shall be evaluated in the end use application.
- 6 - These devices are intended to be mounted on a printed wiring board of end-use equipment. The suitability of the connections (including spacings) shall be determined in the end-use application.
- 7 - Primary terminals shall not be straightened since assembly of housing case depends upon bending of the terminals.
- 8 - Any surface of polymeric housing have not been evaluated as insulating barrier.
- 9 - Low voltage circuits are intended to be powered by a circuit derived from an isolating source (such as a transformer, optical isolator, limiting impedance or electro-mechanical relay) and having no direct connection back to the primary circuit (other than through the grounding means).

Marking

Only those products bearing the UR Mark should be considered to be Listed or Recognized and covered under UL's Follow-Up Service. Always look for the Mark on the product.

Insulation coordination

Parameter	Symbol	Unit	Value	Comment
RMS voltage for AC insulation test, 50 Hz, 1 min	U_d	kV	4.3	
Impulse withstand voltage 1.2/50 μ s	U_{Ni}	kV	8	
Partial discharge RMS test voltage (adjusted $q_m < 10$ pC)	U_t	V	1500	Busbar/Secondary Jumper/Secondary
Clearance (pri. - sec.)	d_{Cl}	mm	> 8	Shortest distance through air
Creepage distance (pri. - sec.)	d_{Cp}	mm	> 8	Shortest path along device body
Case material	-	-	V0	According to UL 94
Comparative tracking index	CTI		600	
Application example		V	600	Reinforced insulation, according to IEC 61800-5-1 CAT III, PD2
Application example		V	1000	Basic insulation, according to IEC 61800-5-1, CAT III, PD2

Environmental and mechanical characteristics

Parameter	Symbol	Unit	Min	Typ	Max	Comment
Ambient operating temperature	T_A	°C	-40		105	
Ambient storage temperature	$T_{A\text{st}}$	°C	-40		105	
Mass	m	g		32		

Electrical data HO 100-SW

 At $T_A = 25\text{ °C}$, $U_C = +5\text{ V}$, unloaded, unless otherwise noted (see Min, Max, typ. definition paragraph in page 17).

Parameter	Symbol	Unit	Min	Typ	Max	Comment
Primary nominal RMS current	I_{PN}	A		100		
Primary current, measuring range	I_{PM}	A	-250		250	
Number of primary turns	N_P	-		1		See application information
Supply voltage	U_C	V	4.5	5	5.5	
Current consumption	I_C	mA		24	31	Unloaded and output mode = 0
Density of ones @ $I_P = 0\text{ A}$	D_{out}	%		50		
Density of ones @ $\pm I_{PN}$	D_{out}	%		50 ± 16		
Density of ones @ $\pm I_{PM}$	D_{out}	%		50 ± 40		
Allowed load capacitance	C_L	pF	0		30	
OCD output on resistance	$R_{on\text{OCD}}$	Ω	60	95	170	Open drain, active low Over operating temperature range
OCD output hold time	$t_{hold\text{OCD}}$	ms	0.8	1.2	1.7	Additional time after threshold has released
EEPROM control	D_{out}	%		0		Forced to 0 when EEPROM in an error state
Electrical offset for PDM output (@ $I_P = 0\text{ A}$)	D_{OE}	%	-0.1		0.1	Relative to $D_{out} = 50\%$
Electrical offset current referred to primary	I_{OE}	A	-0.625		0.625	
Temperature coefficient of I_{OE} @ $I_P = 0\text{ A}$	TCI_{OE}	mA/K	-8.75		8.75	-40 °C ... 105 °C
Nominal sensitivity	S_N	%/A		0.16		16 % @ I_{PN}
Sensitivity error @ I_{PN}	ε_S	%	-1.1		1.1	Factory adjustment (straight bus bar)
Temperature coefficient of S	TCS	ppm/K	-350		350	-40 °C ... 105 °C
Linearity error 0 ... I_{PN}	ε_L	% of I_{PN}	-0.6		0.6	
Linearity error 0 ... I_{PM}	ε_L	% of I_{PM}	-0.5		0.5	
Magnetic offset current (@ $10 \times I_{PN}$) referred to primary	I_{OM}	A	-0.92		0.92	One turn
Delay time to @ 90 % of the final output value for I_{PN} step	t_{D90}	μs				Determined by digital filter and OSR
Primary current, detection threshold	I_{PTh}	A	$2.67 \times I_{PN}$	$2.97 \times I_{PN}$	$3.27 \times I_{PN}$	Peak value $\pm 10\%$, overcurrent detection (OCD)
Sum of sensitivity and linearity @ I_{PN}	ε_{SL}	% of I_{PN}	-1.7		1.7	
Sum of sensitivity and linearity @ I_{PN} @ $T_A = +105\text{ °C}$	ε_{SL}	% of I_{PN}	-5.2		5.2	
Sum of sensitivity and linearity @ I_{PN} @ $T_A = +85\text{ °C}$	ε_{SL}	% of I_{PN}	-4.33		4.33	See formula note ¹⁾

 Notes: ¹⁾ 3.3 V SP version available

²⁾ See page 13

³⁾ See page 15

$$\varepsilon_{SL}(T_A) = \varepsilon_{SL25} + \left(TCS + \frac{TCI_{OE}}{I_{PN}} \right) \times |T_A - 25|$$

Electrical data HO 150-SW

 At $T_A = 25\text{ °C}$, $U_C = +5\text{ V}$, unloaded, unless otherwise noted (see Min, Max, typ. definition paragraph in page 17).

Parameter	Symbol	Unit	Min	Typ	Max	Comment
Primary nominal RMS current	I_{PN}	A		150		
Primary current, measuring range	I_{PM}	A	-375		375	
Number of primary turns	N_P	-		1		See application information
Supply voltage	U_C	V	4.5	5	5.5	
Current consumption	I_C	mA		24	31	Unloaded and output mode = 0
Density of ones @ $I_P = 0\text{ A}$	D_{out}	%		50		
Density of ones @ $\pm I_{PN}$	D_{out}	%		50 ± 16		
Density of ones @ $\pm I_{PM}$	D_{out}	%		50 ± 40		
Allowed load capacitance	C_L	pF	0		30	
OCD output on resistance	$R_{on\text{OCD}}$	Ω	60	95	170	Open drain, active low Over operating temperature range
OCD output hold time	$t_{hold\text{OCD}}$	ms	0.8	1.2	1.7	Additional time after threshold has released
EEPROM control	D_{out}	%		0		Forced to 0 when EEPROM in an error state
Electrical offset for PDM output (@ $I_P = 0\text{ A}$)	D_{OE}	%	-0.1		0.1	Relative to $D_{out} = 50\%$
Electrical offset current referred to primary	I_{OE}	A	-0.94		0.94	
Temperature coefficient of I_{OE} @ $I_P = 0\text{ A}$	TCI_{OE}	mA/K	-13.1		13.1	-40 °C ... 105 °C
Nominal sensitivity	S_N	%/A		0.1067		16 % @ I_{PN}
Sensitivity error @ I_{PN}	ε_S	%	-1.1		1.1	Factory adjustment (straight bus bar)
Temperature coefficient of S	TCS	ppm/K	-350		350	-40 °C ... 105 °C
Linearity error 0 ... I_{PN}	ε_L	% of I_{PN}	-0.5		0.5	
Linearity error 0 ... I_{PM}	ε_L	% of I_{PM}	-0.5		0.5	
Magnetic offset current (@ $10 \times I_{PN}$) referred to primary	I_{OM}	A	-0.92		0.92	One turn
Delay time to @ 90 % of the final output value for I_{PN} step	t_{D90}	μs				Determined by digital filter and OSR
Primary current, detection threshold	I_{PTh}	A	$2.67 \times I_{PN}$	$2.97 \times I_{PN}$	$3.27 \times I_{PN}$	Peak value $\pm 10\%$, overcurrent detection (OCD)
Sum of sensitivity and linearity @ I_{PN}	ε_{SL}	% of I_{PN}	-1.6		1.6	
Sum of sensitivity and linearity @ I_{PN} @ $T_A = +105\text{ °C}$	ε_{SL}	% of I_{PN}	-5.1		5.1	See formula note ¹⁾
Sum of sensitivity and linearity @ I_{PN} @ $T_A = +85\text{ °C}$	ε_{SL}	% of I_{PN}	-4.23		4.23	

Notes: ¹⁾ 3.3 V SP version available

²⁾ See page 13

³⁾ See page 15

$$\varepsilon_{SL}(T_A) = \varepsilon_{SL25} + \left(TCS + \frac{TCI_{OE}}{I_{PN}} \right) \times |T_A - 25|$$

Electrical data HO 200-SW

 At $T_A = 25\text{ °C}$, $U_C = +5\text{ V}$, unloaded, unless otherwise noted (see Min, Max, typ. definition paragraph in page 17).

Parameter	Symbol	Unit	Min	Typ	Max	Comment
Primary nominal RMS current	I_{PN}	A		200		
Primary current, measuring range	I_{PM}	A	-500		500	
Number of primary turns	N_P	-		1		See application information
Supply voltage	U_C	V	4.5	5	5.5	
Current consumption	I_C	mA		24	31	Unloaded and output mode = 0
Density of ones @ $I_P = 0\text{ A}$	D_{out}	%		50		
Density of ones @ $\pm I_{PN}$	D_{out}	%		50 ± 16		
Density of ones @ $\pm I_{PM}$	D_{out}	%		50 ± 40		
Allowed load capacitance	C_L	pF	0		30	
OCD output on resistance	$R_{on\text{OCD}}$	Ω	60	95	170	Open drain, active low Over operating temperature range
OCD output hold time	$t_{hold\text{OCD}}$	ms	0.8	1.2	1.7	Additional time after threshold has released
EEPROM control	D_{out}	%		0		Forced to 0 when EEPROM in an error state
Electrical offset for PDM output (@ $I_P = 0\text{ A}$)	D_{OE}	%	-0.1		0.1	Relative to $D_{out} = 50\%$
Electrical offset current referred to primary	I_{OE}	A	-1.25		1.25	
Temperature coefficient of I_{OE} @ $I_P = 0\text{ A}$	TCI_{OE}	mA/K	-17.5		17.5	-40 °C ... 105 °C
Nominal sensitivity	S_N	%/A		0.08		16 % @ I_{PN}
Sensitivity error @ I_{PN}	ε_S	%	-1.1		1.1	Factory adjustment (straight bus bar)
Temperature coefficient of S	TCS	ppm/K	-350		350	-40 °C ... 105 °C
Linearity error 0 ... I_{PN}	ε_L	% of I_{PN}	-0.5		0.5	
Linearity error 0 ... I_{PM}	ε_L	% of I_{PM}	-0.5		0.5	
Magnetic offset current (@ $10 \times I_{PN}$) referred to primary	I_{OM}	A	-0.92		0.92	One turn
Delay time to @ 90 % of the final output value for I_{PN} step	t_{D90}	μs				Determined by digital filter and OSR
Primary current, detection threshold	I_{PTh}	A	$2.67 \times I_{PN}$	$2.97 \times I_{PN}$	$3.27 \times I_{PN}$	Peak value $\pm 10\%$, overcurrent detection (OCD)
Sum of sensitivity and linearity @ I_{PN}	ε_{SL}	% of I_{PN}	-1.6		1.6	
Sum of sensitivity and linearity @ I_{PN} @ $T_A = +105\text{ °C}$	ε_{SL}	% of I_{PN}	-5.1		5.1	See formula note ¹⁾
Sum of sensitivity and linearity @ I_{PN} @ $T_A = +85\text{ °C}$	ε_{SL}	% of I_{PN}	-4.23		4.23	

 Notes: ¹⁾ 3.3 V SP version available

²⁾ See page 13

³⁾ See page 15

⁴⁾
$$\varepsilon_{SL}(T_A) = \varepsilon_{SL25} + \left(TCS + \frac{TCI_{OE}}{I_{PN}} \right) \times |T_A - 25|$$

Electrical data HO 250-SW

 At $T_A = 25\text{ °C}$, $U_C = +5\text{ V}$, unloaded, unless otherwise noted (see Min, Max, typ. definition paragraph in page 17).

Parameter	Symbol	Unit	Min	Typ	Max	Comment
Primary nominal RMS current	I_{PN}	A		250		
Primary current, measuring range	I_{PM}	A	-625		625	
Number of primary turns	N_P	-		1		See application information
Supply voltage	U_C	V	4.5	5	5.5	
Current consumption	I_C	mA		24	31	Unloaded and output mode = 0
Density of ones @ $I_P = 0\text{ A}$	D_{out}	%		50		
Density of ones @ $\pm I_{PN}$	D_{out}	%		50 ± 16		
Density of ones @ $\pm I_{PM}$	D_{out}	%		50 ± 40		
Allowed load capacitance	C_L	pF	0		30	
OCD output on resistance	$R_{on\text{OCD}}$	Ω	60	95	170	Open drain, active low Over operating temperature range
OCD output hold time	$t_{hold\text{OCD}}$	ms	0.8	1.2	1.7	Additional time after threshold has released
EEPROM control	D_{out}	%		0		Forced to 0 when EEPROM in an error state
Electrical offset for PDM output (@ $I_P = 0\text{ A}$)	D_{OE}	%	-0.1		0.1	Relative to $D_{out} = 50\%$
Electrical offset current referred to primary	I_{OE}	A	-1.56		1.56	
Temperature coefficient of I_{OE} @ $I_P = 0\text{ A}$	TCI_{OE}	mA/K	-21.9		21.9	-40 °C ... 105 °C
Nominal sensitivity	S_N	%/A		0.064		16 % @ I_{PN}
Sensitivity error @ I_{PN}	ε_S	%	-1.1		1.1	Factory adjustment (straight bus bar)
Temperature coefficient of S	TCS	ppm/K	-350		350	-40 °C ... 105 °C
Linearity error 0 ... I_{PN}	ε_L	% of I_{PN}	-0.5		0.5	
Linearity error 0 ... I_{PM}	ε_L	% of I_{PM}	-0.5		0.5	
Magnetic offset current (@ $10 \times I_{PN}$) referred to primary	I_{OM}	A	-0.92		0.92	One turn
Delay time to @ 90 % of the final output value for I_{PN} step	t_{D90}	μs				Determined by digital filter and OSR
Primary current, detection threshold	I_{PTh}	A	$2.67 \times I_{PN}$	$2.97 \times I_{PN}$	$3.27 \times I_{PN}$	Peak value $\pm 10\%$, overcurrent detection (OCD)
Sum of sensitivity and linearity @ I_{PN}	ε_{SL}	% of I_{PN}	-1.6		1.6	
Sum of sensitivity and linearity @ I_{PN} @ $T_A = +105\text{ °C}$	ε_{SL}	% of I_{PN}	-5.1		5.1	
Sum of sensitivity and linearity @ I_{PN} @ $T_A = +85\text{ °C}$	ε_{SL}	% of I_{PN}	-4.23		4.23	See formula note ¹⁾

Notes: ¹⁾ 3.3 V SP version available

²⁾ See page 13

³⁾ See page 15

⁴⁾
$$\varepsilon_{SL}(T_A) = \varepsilon_{SL} 25 + \left(TCS + \frac{TCI_{OE}}{I_{PN}} \right) \times |T_A - 25|$$

HO-SW series output characteristics

Mode 0 and 8: 2 Wire CMOS

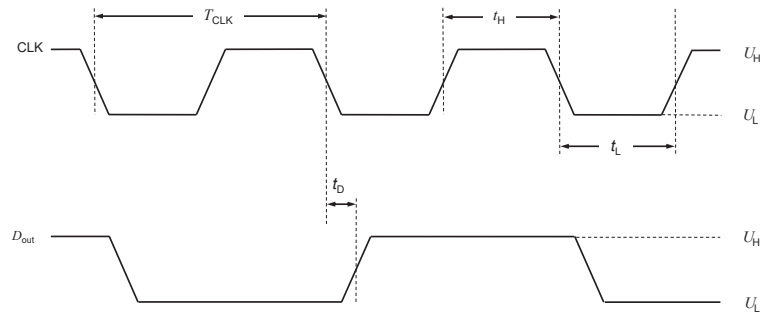

For all allowed capacitive range

• Timing for mode 0

Parameter	Symbol	Unit	Min	Typ	Max	Comment
Clock period	T_{CLK}	ns	89	93.5	98	For internal clock
Temperature coefficient of clock period	$TCt_{per CLK}$	ppm/K	-400	0	400	-40 °C ... 105 °C
Clock high time	$t_{CLK H}$	ns	$0.45 \times T_{CLK}$	46.75	$0.55 \times T_{CLK}$	
Clock falling edge to data delay	$t_{CLK D}$	ns	-25	0	25	

• Timing for mode 8

Parameter	Symbol	Unit	Min	Typ	Max	Comment
Clock high time	$t_{CLK H}$	ns	$0.45 \times T_{CLK}$	$0.5 \times T_{CLK}$	$0.55 \times T_{CLK}$	
Clock falling edge to data delay	$t_{CLK D}$	ns	13	0	49	

In mode 8, you can use external clock from 5 to 10.1 MHz or from 11.4 to 12.5 MHz.

• Levels

Parameter	Symbol	Unit	Min	Typ	Max	Comment
Low voltage	U_L	V			0.4	with $I_{out L} = 4$ mA, unloaded
High voltage	U_H	V	$U_C - 0.4$			with $I_{out H} = -4$ mA, unloaded

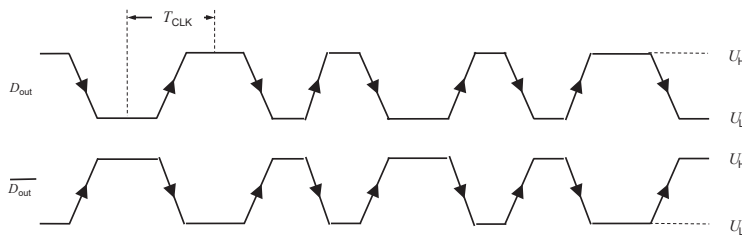
Mode 1: 2 Wire RS 422 Manchester (ANSI/TIA/EIA-422-B and IEEE 802.3)

For all allowed capacitive range, R_L can be 100 Ohm.

Logical 1 is coding on a rising edge on D_{out} .

- Timing for mode 1

Parameter	Symbol	Unit	Min	Typ	Max	Comment
Clock period	T_{CLK}	ns	89	93.5	98	$f_{CLK} = 10.7 \text{ MHz} \pm 5 \%$
Temperature coefficient of clock period	$TCt_{per CLK}$	ppm/K	-400	0	400	-40 °C ... 105 °C

- Levels

Parameter	Symbol	Unit	Min	Typ	Max	Comment
Low voltage	U_L	V			0.4	with $I_{outL} = 4 \text{ mA}$, unloaded
High voltage	U_H	V	$U_C - 0.4$			with $I_{outH} = -4 \text{ mA}$, unloaded

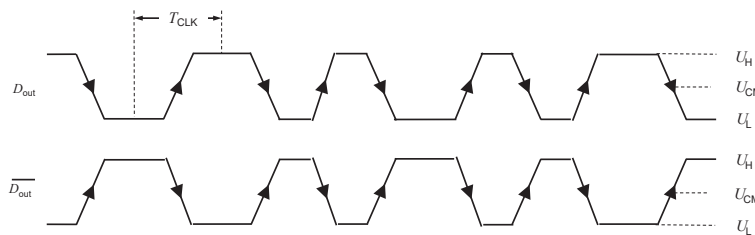
Mode 3: 2 Wire LVDS Manchester (ANSI/TIA/EIA-644-A and IEEE 802.3)

For all allowed capacitive range, recommended load resistor $R_L = 100 \text{ Ohm}$.

Logical 1 is coding on a rising edge on D_{out} .

- Timing for mode 3

Parameter	Symbol	Unit	Min	Typ	Max	Comment
Clock period	T_{CLK}	ns	89	93.5	98	$f_{CLK} = 10.7 \text{ MHz} \pm 5 \%$
Temperature coefficient of clock period	$TCt_{per CLK}$	ppm/K	-400	0	400	-40 °C ... 105 °C

- Levels

Parameter	Symbol	Unit	Min	Typ	Max	Comment
Low voltage	U_L	mV		$(-3.5 \times R_L) / 2$		Relative to U_{CM}
High voltage	U_H	mV		$(3.5 \times R_L) / 2$		Relative to U_{CM}
Common mode voltage	U_{CM}	V		1.25		

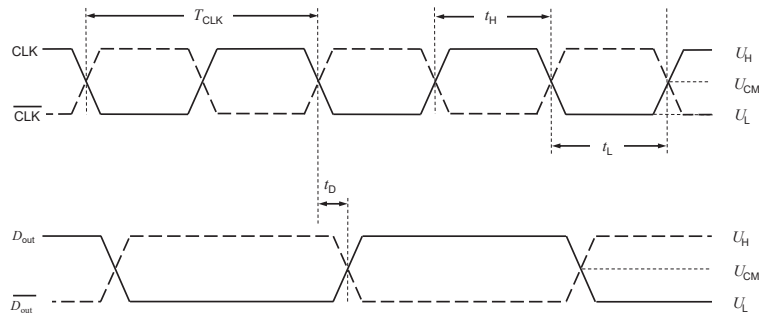
Mode 2 and A: 4 Wire LVDS (ANSI/TIA/EIA-644-A)

For all allowed capacitive range, recommended load resistor $R_L = 100 \text{ Ohm}$.

- Timing for mode 2

Parameter	Symbol	Unit	Min	Typ	Max	Comment
Clock period	T_{CLK}	ns	89	93.5	98	For internal clock
Temperature coefficient of clock period	$TCt_{\text{per CLK}}$	ppm/K	-400	0	400	-40 °C ... 105 °C
Clock high time	$t_{\text{CLK H}}$	ns	$0.45 \times T_{\text{CLK}}$	46.75	$0.55 \times T_{\text{CLK}}$	
Clock falling edge to data delay	$t_{\text{CLK D}}$	ns	-25	0	25	

- Timing for mode A

Parameter	Symbol	Unit	Min	Typ	Max	Comment
Clock high time	$t_{\text{CLK H}}$	ns	$0.45 \times T_{\text{CLK}}$	$0.5 \times T_{\text{CLK}}$	$0.55 \times T_{\text{CLK}}$	
Clock falling edge to data delay	$t_{\text{CLK D}}$	ns	13	0	49	

In mode A, you can use external clock from 5 to 10.1 MHz or from 11.4 to 12.5 MHz.

- Levels

Parameter	Symbol	Unit	Min	Typ	Max	Comment
Low voltage	U_L	mV		$(-3.5 \times R_L) / 2$		Relative to U_{CM}
High voltage	U_H	mV		$(3.5 \times R_L) / 2$		Relative to U_{CM}
Common mode voltage	U_{CM}	V		1.25		

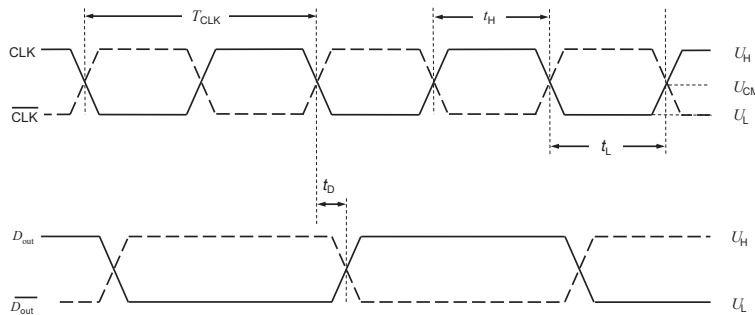
Mode 4, C and D: 4 Wire RS 422 (ANSI/TIA/EIA-422-B)

For all allowed capacitive range, R_L can be 100 Ohm.

- Timing for mode 4

Parameter	Symbol	Unit	Min	Typ	Max	Comment
Clock period	T_{CLK}	ns	89	93.5	98	For internal clock
Temperature coefficient of clock period	$TCr_{per CLK}$	ppm/K	-400	0	400	-40 °C ... 105 °C
Clock high time	t_{CLKH}	ns	$0.45 \times T_{CLK}$	46.75	$0.55 \times T_{CLK}$	
Clock falling edge to data delay	t_{CLKD}	ns	-25	0	25	

- Timing for mode C and D

Parameter	Symbol	Unit	Min	Typ	Max	Comment
Clock high time	t_{CLKH}	ns	$0.45 \times T_{CLK}$	$0.5 \times T_{CLK}$	$0.55 \times T_{CLK}$	
Clock falling edge to data delay	t_{CLKD}	ns	13	0	49	

In mode C and D, you can use external clock from 5 to 10.1 MHz or from 11.4 to 12.5 MHz.

- Levels

Parameter	Symbol	Unit	Min	Typ	Max	Comment
Low voltage	U_L	V			0.4	with $I_{outL} = 4$ mA, unloaded
High voltage	U_H	V	$U_C - 0.4$			with $I_{outH} = -4$ mA, unloaded
Common mode voltage in mode C	U_{CM}	V	$0.35 \times U_C$		$0.75 \times U_C$	
Common mode voltage in mode D	U_{CM}	V		0		

Mode D fully compatible with RS 422 standard (ANSI/TIA/EIA-422-B).

Capacitors on CLK and \overline{CLK} signals needed to avoid common mode voltage.

HO-SW series output characteristics

Modulator output: Density of ones versus % of I_{PN}

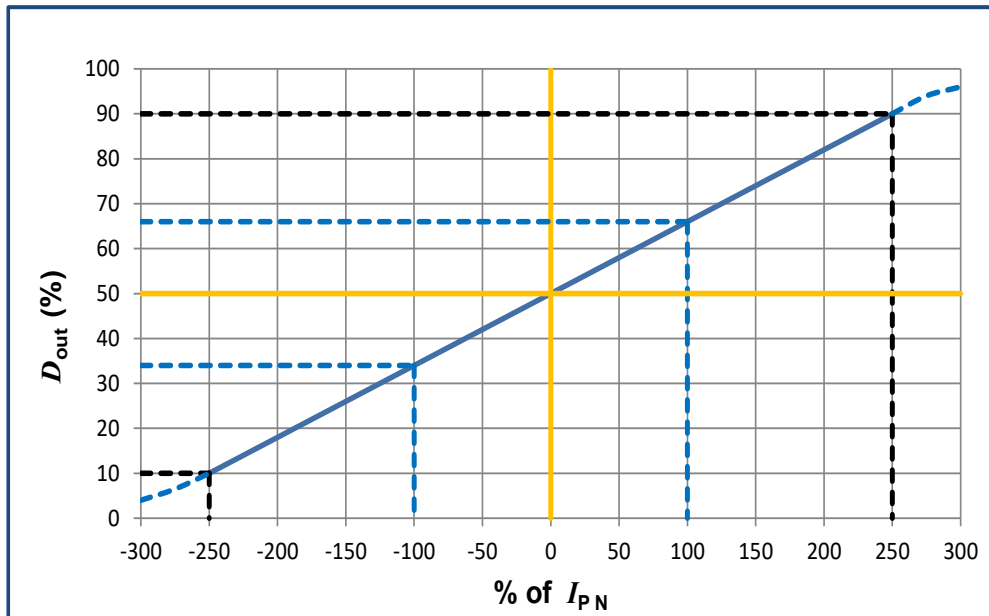

Maximum continuous DC current

For all ranges:

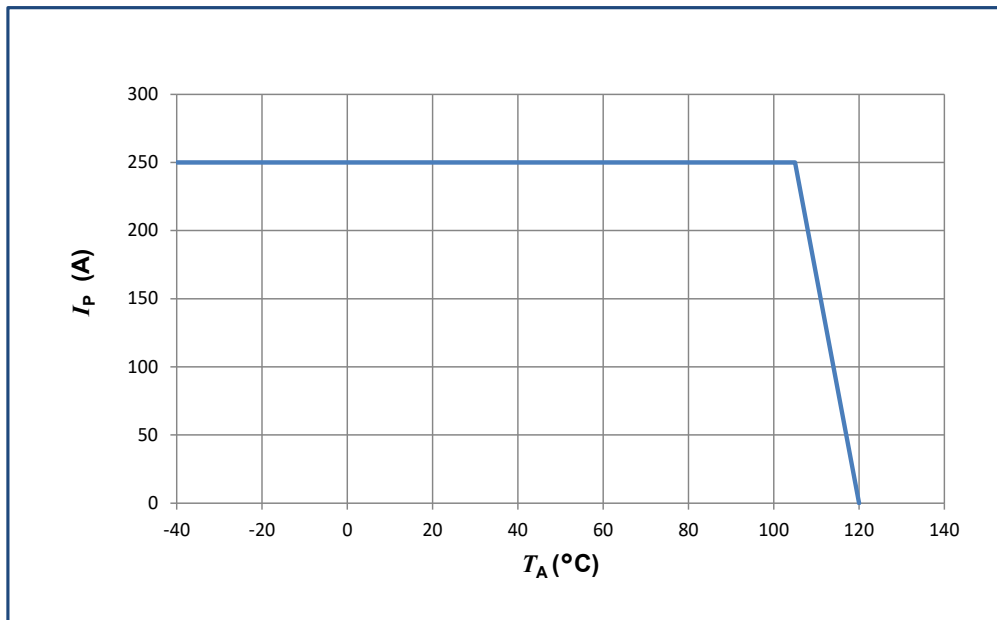

Important notice: whatever the usage and/or application, the transducer primary bar / jumper temperature shall not go above the maximum rating of 120 °C as stated in page 2 of this datasheet.

HO-SW series output characteristics

Frequency derating versus primary current and core temperature increase ΔT (°C)

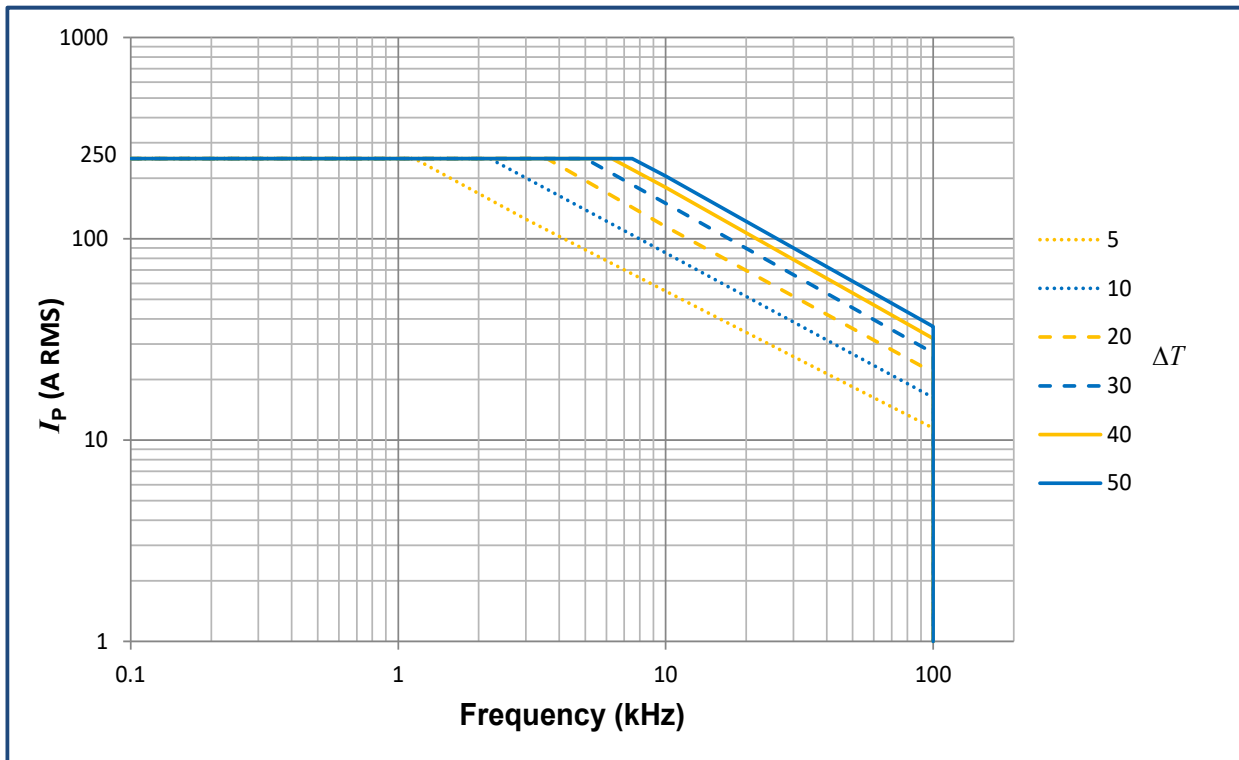

Primary current in A RMS is sine wave.
 Example:
 Primary current ripple (sine wave): 50 A RMS
 Ripple frequency: 20 kHz
 - the core temperature increase is 10 °C.

Consumption

Typical values with $C_L = 5$ pF

Output Mode	I_c unloaded (mA)	I_c with $R_L = 100$ Ohm (mA)
0	24	-
1	24	53
2	-	37
3	-	30
4	25	82
8	24	-
A	-	30
C	24	53
D	24	53

Effective resolution versus OSR

HO 100-SW-xxxx

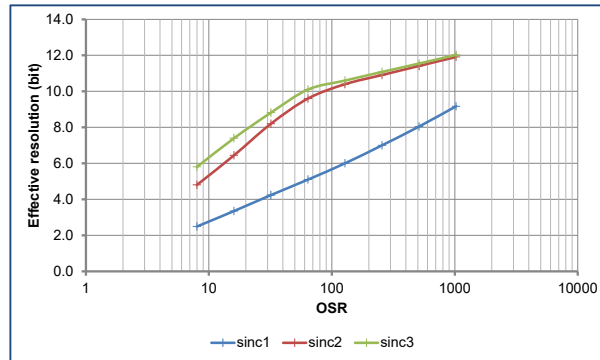

HO 150-SW-xxxx

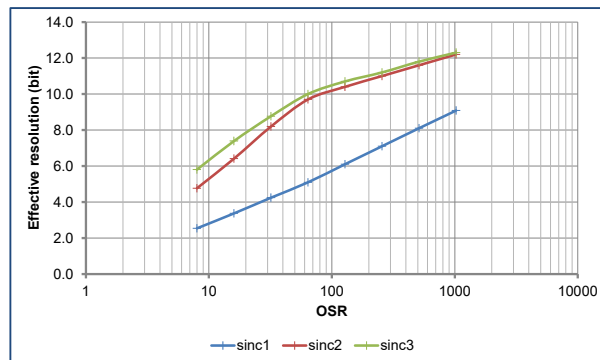

HO 200-SW-xxxx

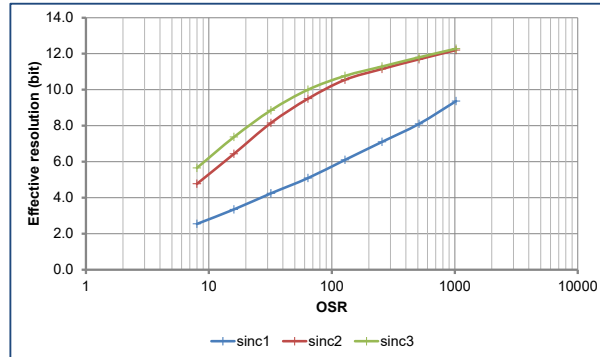

HO 250-SW-xxxx

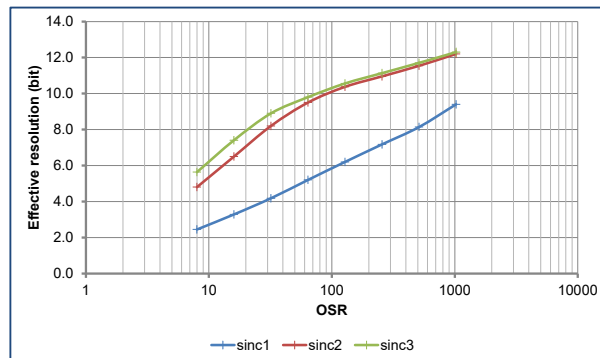

Signal to noise ratio

$$\text{SNR (dB)} = 20 \cdot \log_{10}(2) / \text{Effective resolution}$$

Delay time versus OSR

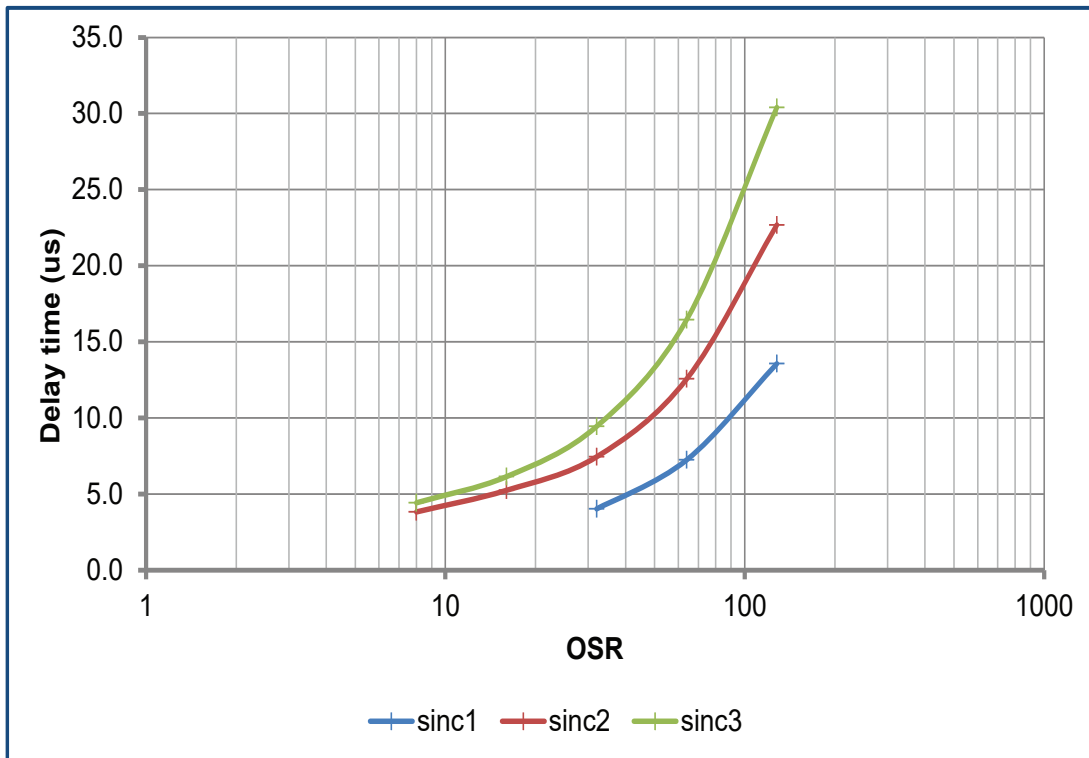

Bandwidth (-3 dB) versus OSR

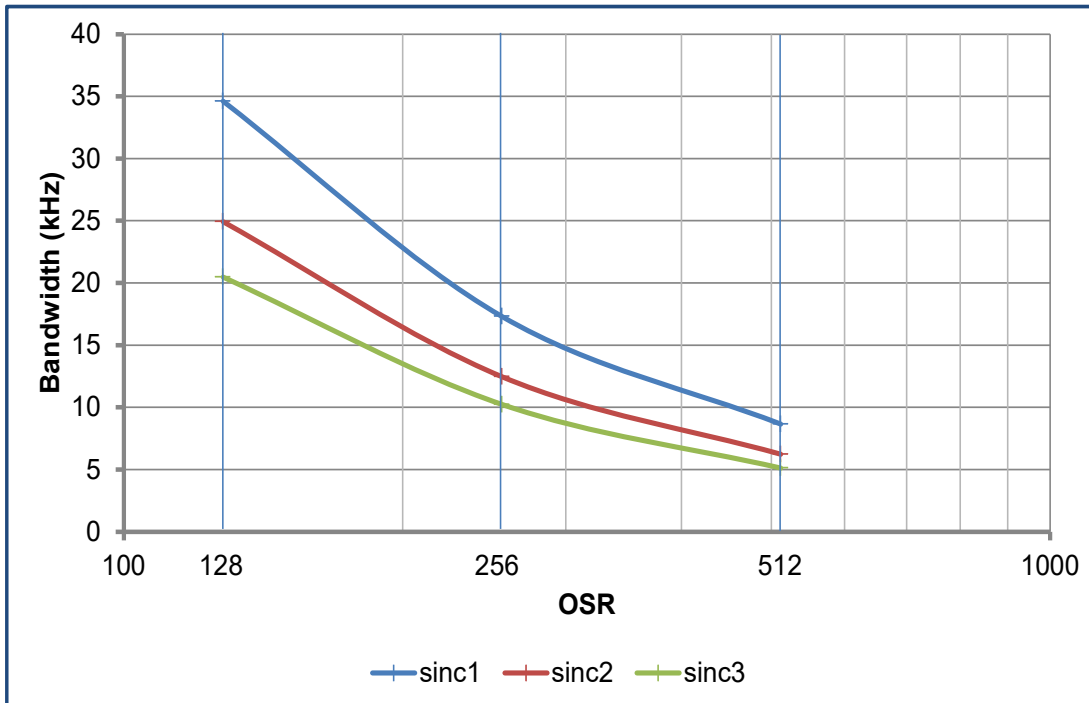

Theoretical values due to customer filter configuration

HO-SW series: name and codification

HO-SW family products may be ordered **on request** ¹⁾ with a dedicated setting of the parameters as described below (standards products are delivered with the setting 0000 according to the table).

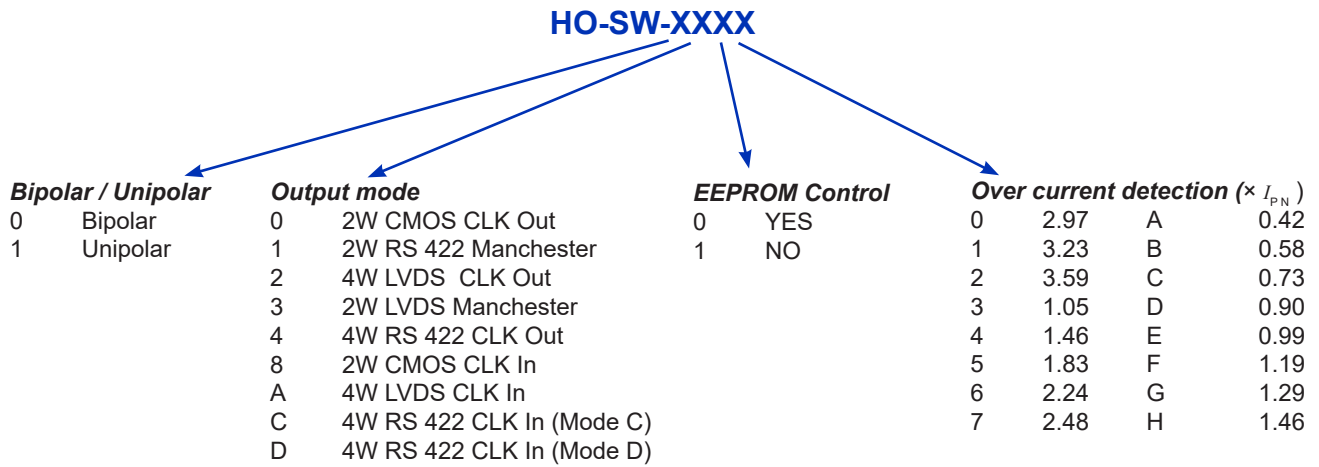

Standard products are:

HO 100-SW-0000
 HO 150-SW-0000
 HO 200-SW-0000
 HO 250-SW-0000

Other products available:

HO 100-SW-0100	HO 100-SW-0800
HO 150-SW-0100	HO 150-SW-0800
HO 200-SW-0100	HO 200-SW-0800
HO 250-SW-0100	HO 250-SW-0800
HO 100-SW-0200	HO 100-SW-0A00
HO 150-SW-0200	HO 150-SW-0A00
HO 200-SW-0200	HO 200-SW-0A00
HO 250-SW-0200	HO 250-SW-0A00
HO 100-SW-0300	HO 100-SW-0C00
HO 150-SW-0300	HO 150-SW-0C00
HO 200-SW-0300	HO 200-SW-0C00
HO 250-SW-0300	HO 250-SW-0C00
HO 100-SW-0400	HO 100-SW-0D00
HO 150-SW-0400	HO 150-SW-0D00
HO 200-SW-0400	HO 200-SW-0D00
HO 250-SW-0400	HO 250-SW-0D00

Note: ¹⁾ For dedicated settings, minimum quantities apply, please contact your local LEM support.

Application information

- HO-SW series is designed to use a bus-bar or a cable ¹⁾ to carry the current through out the aperture with a maximum capacity of 8 × 15 mm.
- Use of a bare conductor is not recommended with panel mounting (either horizontal or vertical) as insulation distances might be compromised between the busbar and fixation screws.

Note: ¹⁾ The maximum magnetic offset referred to primary is inversely proportional to the number of turns, thus is divided by 2 with 2 turns.

Definition of typical, minimum and maximum values

Minimum and maximum values for specified limiting and safety conditions have to be understood as such as well as values shown in “typical” graphs.

On the other hand, measured values are part of a statistical distribution that can be specified by an interval with upper and lower limits and a probability for measured values to lie within this interval.

Unless otherwise stated (e.g. “100 % tested”), the LEM definition for such intervals designated with “min” and “max” is that the probability for values of samples to lie in this interval is 99.73 %.

For a normal (Gaussian) distribution, this corresponds to an interval between -3 sigma and +3 sigma. If “typical” values are not obviously mean or average values, those values are defined to delimit intervals with a probability of 68.27 %, corresponding to an interval between -sigma and +sigma for a normal distribution. Typical, minimum and maximum values are determined during the initial characterization of the product.

Remark

Installation of the transducer must be done unless otherwise specified on the datasheet, according to LEM Transducer Generic Mounting Rules. Please refer to LEM document N°ANE120504 available on our Web site: <https://www.lem.com/en/file/3137/download>

Safety

This transducer must be used in limited-energy secondary circuits according to IEC 61010-1.



This transducer must be used in electric/electronic equipment with respect to applicable standards and safety requirements in accordance with the manufacturer’s operating instructions.



Caution, risk of electrical shock

When operating the transducer, certain parts of the module can carry hazardous voltage (eg. primary busbar, power supply). Ignoring this warning can lead to injury and/or cause serious damage. This transducer is a build-in device, whose conducting parts must be inaccessible after installation. A protective housing or additional shield could be used. Main supply must be able to be disconnected.

Although LEM applies utmost care to facilitate compliance of end products with applicable regulations during LEM product design, use of this part may need additional measures on the application side for compliance with regulations regarding EMC and protection against electric shock. Therefore LEM cannot be held liable for any potential hazards, damages, injuries or loss of life resulting from the use of this product.

Insulation distance (nominal values):

	d_{CP}	d_{CI}
Between primary busbar and secondary pin	14.6 mm	-
Between primary busbar and core	-	12.6 mm
Between core and secondary terminal	-	1.18 mm

Dimensions (in mm, general linear tolerance ± 0.6 mm)

Mounting example: horizontal

Technical drawing showing dimensions and connection details for the HO 100 ... 250-SW series transducer. Dimensions include: 18.8, 15.97, 6.8, 9.1, 29.96, 10.5, 9.5, 11.8, 5.5, 37.8, 44.13, 33.2, 4.7, 9.6, 2.3, 40.8, 31.4, 13.4, 18.2, 16.95, 6.1, 3 (x2), 1.25 (x7), 8, 18.8, 15.97, 6.8, 9.1, 29.96, 10.5, 9.5, 11.8, 5.5, 37.8, 44.13, 33.2, 4.7, 9.6, 2.3, 40.8, 31.4, 13.4, 18.2, 16.95, 6.1, 3 (x2), 1.25 (x7), 8. Dimensions busbar 15mm x 8mm. Hall element position. MARKING AREA. Numbering pin. Tightening torque= 1 Nm (Screw + washer).

Connection

Output Mode	P5	P6	P7	P1	P2
0 2W CMOS CLK Out	GND or NC	NC	NC	CLK	D_{out}
1 2W RS 422 MANCHESTER	GND or NC	NC	NC	\overline{D}_{out}	D_{out}
2 4W LVDS CLK Out	GND or NC	CLK	\overline{CLK}	\overline{D}_{out}	D_{out}
3 2W LVDS MANCHESTER	GND or NC	NC	NC	\overline{D}_{out}	D_{out}
4 4W RS 422 CLK Out	GND or NC	CLK	\overline{CLK}	\overline{D}_{out}	D_{out}
8 2W CMOS CLK In	U_c	NC	NC	CLK	D_{out}
A 4W LVDS CLK In	U_c	CLK	\overline{CLK}	\overline{D}_{out}	D_{out}
C 4W RS 422 CLK In (Mode C)	U_c	CLK	\overline{CLK}	\overline{D}_{out}	D_{out}
D 4W RS 422 In (Mode D)	U_c	CLK	\overline{CLK}	\overline{D}_{out}	D_{out}

Remarks:

- Density of ones is greater than 50 % when positive I_p flows in direction of the arrow shown on the drawing above
- Connection system: equivalent to HARWIN M30-6100846 type
- Mounting foot may be removed and repositioned as shown on pages 18,19 and 20 of this datasheet. We recommend to change the mounting foot position just once.

Dimensions (in mm, general linear tolerance ± 0.6 mm)

Mounting example: vertical

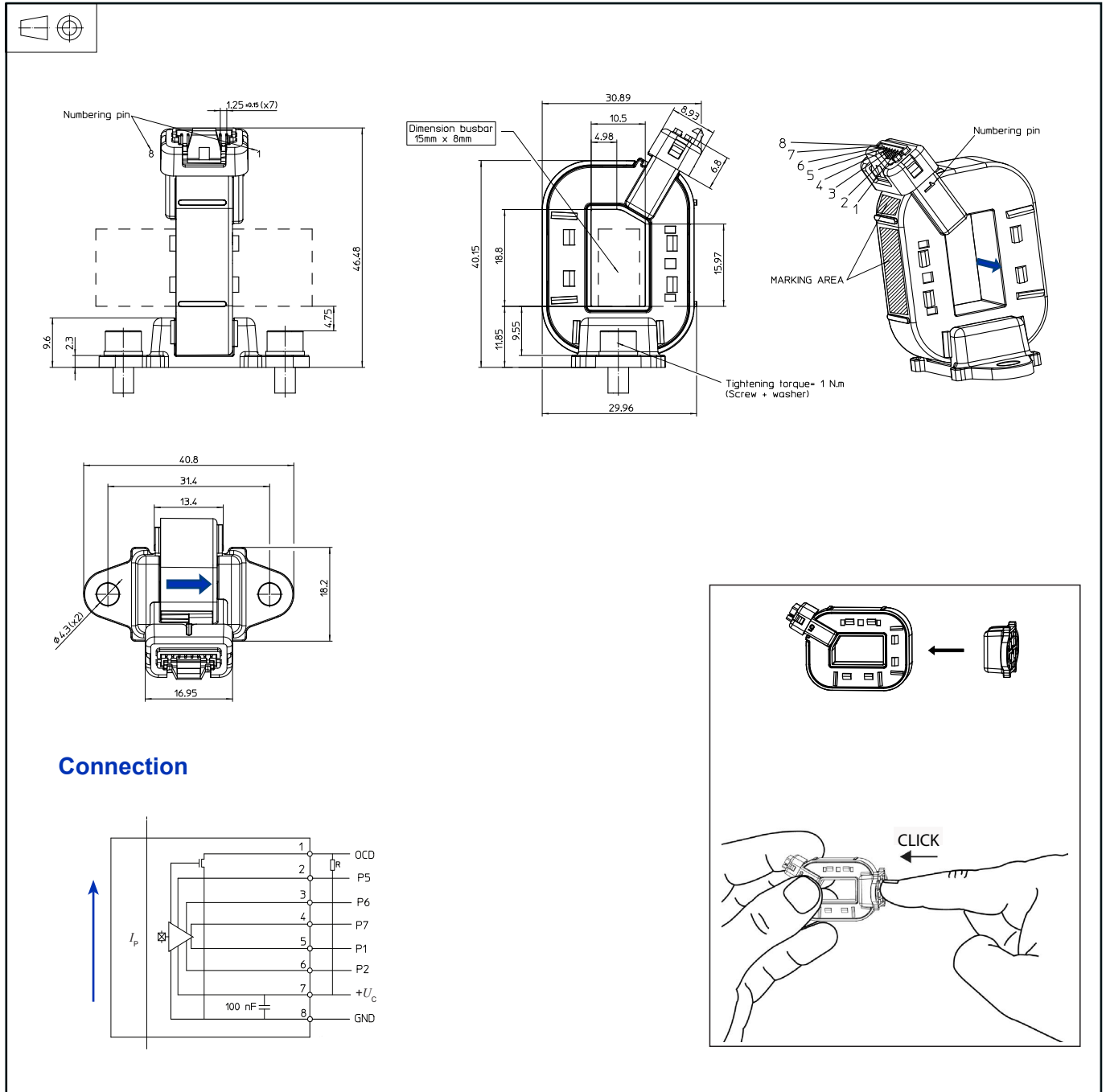

Remarks:

- Density of ones is greater than 50 % when positive I_p flows in direction of the arrow shown on the drawing above
- Connection system: equivalent to HARWIN M30-6100846 type
- Mounting foot may be removed and repositioned as shown on pages 18,19 and 20 of this datasheet. We recommend to change the mounting foot position just once.

Dimensions (in mm, general linear tolerance ± 0.6 mm)

Mounting example: busbar

Connection

Remarks:

- Density of ones is greater than 50 % when positive I_p flows in direction of the arrow shown on the drawing above.
- Connection system: equivalent to HARWIN M30-6100846 type
- Mounting foot may be removed and repositioned as shown on pages 18,19 and 20 of this datasheet. We recommend to change the mounting foot position just once.

单击下面可查看定价，库存，交付和生命周期等信息

[>>LEM\(莱姆\)](#)