

Current Transducer ATO-75-B1I-D10

$I_{PR} = 75 A$

For the electronic measurement of current: DC, AC, pulsed..., with galvanic separation between the primary and the secondary circuit.

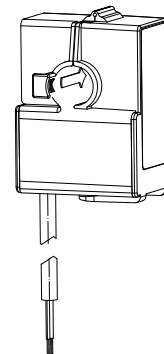

Features

- Split-core current transformer
- Rated primary current: 75 A
- Application up to 600 V CAT III PD2, basic insulation
- Accuracy class 3 (IEC 61869-2)
- Current output 75 mA at I_{Pr}
- \varnothing 10 mm sensing aperture
- 1 m output cable
- Ambient temperature $-30\text{ }^{\circ}\text{C} \dots +70\text{ }^{\circ}\text{C}$
- Very low cost solution
- Slot for attaching the C.T. on the primary with plastic tie
- DIN rail adapter (optional).

Advantages

- No interruption of electricity during installation on insulated conductors
- Quick, non-intrusive and easy setup
- Provide a calibrate output.

Applications

- Hybrid inverter (Home Energy Storage)
- Power metering: current measurement for active power calculation
- Building sub-metering: energy efficiency monitoring, consumption analysis and cost allocation
- Power quality monitoring: electrical loads and distribution system equipment
- Distributed measurement systems
- Condition monitoring (e.g. Motor loads such as conveyers, pumps).

Standards

- IEC 61010-1: 2010
- IEC 61010-031 ed1.1: 2012
- IEC 61869-1 ed1.0: 2007
- IEC 61869-2: ed1.0: 2012
- IEC 61869-6: draft 2016
- UL 508: 2013.

Safety



Caution

If the device is used in a way that is not specified by the manufacturer, the protection provided by the device may be compromised. Always inspect the electronics unit and connecting cable before using this product and do not use it if damaged. Mounting assembly shall guarantee the maximum primary conductor temperature, fulfill clearance and creepage distance, minimize electric and magnetic coupling, and unless otherwise specified can be mounted in any orientation.



Caution, risk of electrical shock

This transducer must be used in limited-energy secondary circuits SELV according to IEC 61010-1, in electric/electronic equipment with respect to applicable standards and safety requirements in accordance with the manufacturer's operating specifications.

Use caution during installation and use of this product; certain parts of the module can carry hazardous voltages and high currents (e.g. power supply, primary conductor).

Ignoring this warning can lead to injury and or/cause serious damage.

De-energize all circuits and hazardous live parts before installing the product.

All installations, maintenance, servicing operations and use must be carried out by trained and qualified personnel practicing applicable safety precautions.

This transducer is a build-in device, whose hazardous live parts must be inaccessible after installation.

This transducer must be mounted in a suitable end-enclosure.

Besides make sure to have a distance of minimum 30 mm between the primary terminals of the transducer and other neighboring components.

Main supply must be able to be disconnected.

Always inspect the flexible probe for damage before using this product.

Never connect or disconnect the external power supply while the primary circuit is connected to live parts.

Never connect the output to any equipment with a common mode voltage to earth greater than 30 V.

Always wear protective clothing and gloves if hazardous live parts are present in the installation where the measurement is carried out.

This transducer is a built-in device, not intended to be cleaned with any product. Nevertheless if the user must implement cleaning or washing process, validation of the cleaning program has to be done by himself.

When defining soldering process, please use no cleaning process only.



ESD susceptibility

The product is susceptible to be damaged from an ESD event and the personnel should be grounded when handling it.

Do not dispose of this product as unsorted municipal waste. Contact a qualified recycler for disposal.

Although LEM applies utmost care to facilitate compliance of end products with applicable regulations during LEM product design, use of this part may need additional measures on the application side for compliance with regulations regarding EMC and protection against electric shock. Therefore LEM cannot be held liable for any potential hazards, damages, injuries or loss of life resulting from the use of this product.



Underwriters Laboratory Inc. recognized component

Absolute maximum ratings

Parameter	Symbol	Unit	Value
Primary conductor temperature	T_B	°C	100

Stresses above these ratings may cause permanent damage.
Exposure to absolute maximum ratings for extended periods may degrade reliability.

UL 508: Ratings and assumptions of certification

File # E189713 Volume: 2 Section: 8

Standards

- CSA C22.2 NO. 14-10 INDUSTRIAL CONTROL EQUIPMENT - Edition 11 - Revision Date 2011/08/01
 - UL 508 STANDARD FOR INDUSTRIAL CONTROL EQUIPMENT - Edition 17 - Revision Date 2013/10/16
- For use only in complete equipment where the acceptability of the combination is determined by UL.LLC.

Ratings

Parameter	Symbol	Unit	Value
Primary involved potential		V AC/DC	1000
Ambient operating temperature	T_A	°C	70
Primary current	I_P	A	125

Conditions of acceptability

When installed in the end-use equipment, consideration shall be given to the following:

- *These devices must be mounted in a suitable end-use enclosure.*
- *The terminals have not been evaluated for field wiring*
- *The products shall be used in a pollution degree 2*
- *Based on results of temperature test, in the end-use application a maximum of 100 °C can not be exceeded on the primary conductor.*

Marking

Only those products bearing the UL or UR Mark should be considered to be Listed or Recognized and covered under UL's Follow-Up Service. Always look for the Mark on the product.

Insulation coordination

Parameter	Symbol	Unit	Value	Comment
RMS voltage for AC insulation test, 50 Hz, 1 min	U_d	kV	4.3	Between primary (completely filling the hole) and secondary
Impulse withstand voltage 1.2/50 μ s	U_{Ni}	kV	7.8	
Partial discharge extinction RMS voltage @ 10 pC	U_e	kV	1.8	
Clearance (pri. - sec.)	d_{Cl}	mm	8	Shortest distance through air
Creepage distance (pri. - sec.)	d_{Cp}	mm	8	Shortest path along device body
Case material flammability	-	--	V0	According to UL 94
Application example	-	V	600	Reinforced insulation according to EN 50178 CAT III PD2
Application example	-	V	300	Reinforced insulation according to EN 61010-1 CAT III PD2
Application example	-	V	600	Basic insulation according to EN 61010-1 CAT IV PD2
Application example	-	V	1000	Basic insulation according to EN 61010-1 CAT III PD2
Application example	-			According to UL 508

Environmental and mechanical characteristics

Parameter	Symbol	Unit	Min	Typ	Max	Comment
Ambient operating temperature	T_A	$^{\circ}$ C	-30		70	
Ambient storage temperature	T_S	$^{\circ}$ C	-30		90	
Relative humidity (non-condensing)	RH	%	0		85	
Altitude above sea level		m			2000	
Surrounding temperature according to UL		$^{\circ}$ C			70	
Mass	m	g		80		

Electrical data ATO-75-B1I-D10

At $T_A = 25\text{ °C}$, $R_{br} = 4\ \Omega$, unless otherwise noted.

Parameter	Symbol	Unit	Min	Value	Max	Comment
Rated burden	R_{br}	Ω		4		
Rated primary current	I_{Pr}	A		75		
Rated extended primary current	I_{ePr}	A		90		
Rated short-time thermal current	I_{th}	kA		4.5		$60 \times I_{Pr}$ (1 s)
Rated dynamic current	I_{dyn}	kA		11.25		$2.5 \times I_{th}$
Rated transformation ratio	k_{ra}	A/A		1000		
Rated secondary Current	I_{Sr}	mA		75		
Rated frequency	f_r	Hz	50		60	

Parameter	Symbol	Unit	Min	Typ	Max	Comment
Frequency bandwidth (-3 dB)	BW	kHz			500	
Phase displacement	$\Delta\varphi$	$^\circ$	0.5		2.5	
Temperature coefficient of I_{out}	TCI_{out}	ppm/k			60	
Coil inductance	L_S	mH		3900		
Coil resistance	R_S	Ω		35		
Ratio error	ε	%	-1		1	
Linearity error	ε_L	%			0.1	

Definition of typical, minimum and maximum values

Minimum and maximum values for specified limiting and safety conditions have to be understood as such as well as values shown in "typical" graphs.

On the other hand, measured values are part of a statistical distribution that can be specified by an interval with upper and lower limits and a probability for measured values to lie within this interval.

Unless otherwise stated (e.g. "100 % tested"), the LEM definition for such intervals designated with "min" and "max" is that the probability for values of samples to lie in this interval is 99.73 %.

For a normal (Gaussian) distribution, this corresponds to an interval between -3 sigma and +3 sigma. If "typical" values are not obviously mean or average values, those values are defined to delimit intervals with a probability of 68.27 %, corresponding to an interval between -sigma and +sigma for a normal distribution.

Typical, minimum and maximum values are determined during the initial characterization of the product.

Typical performance characteristics
Accuracy class 3 according to IEC 61869-2

At $T_A = 25\text{ }^\circ\text{C}$, at frequency = 50 Hz, $R_{br} = 4\ \Omega$, unless otherwise noted.

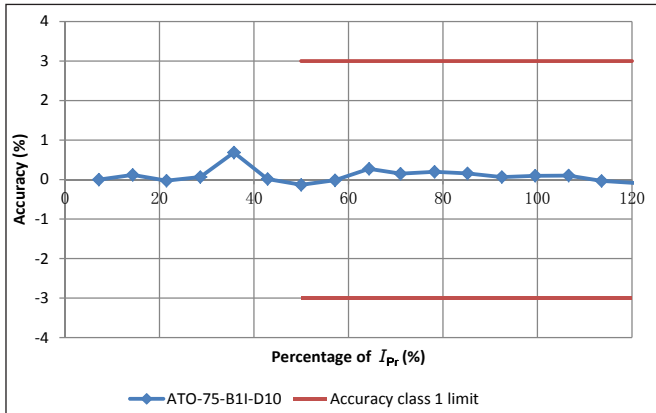

Figure 1: Accuracy vs. Percentage of I_{Pr}

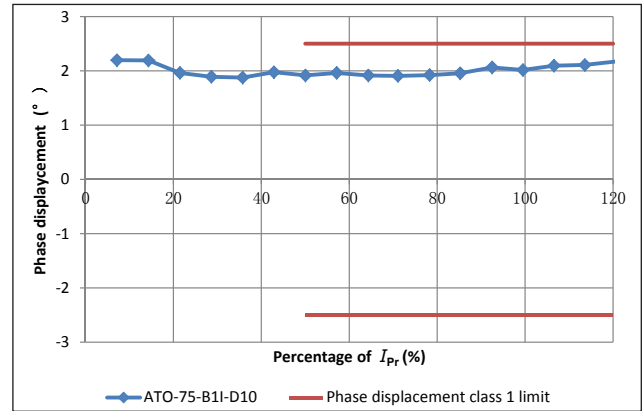

Figure 2: Phase displacement vs. Percentage of I_{Pr}

% of I_{Pr}	Ratio error			Phase displacement		
	50 %	100 %	120 %	50 %	100 %	120 %
Maximum	3 %	3 %	3 %	2.5°	2.5°	2.5°
Minimum	-3 %	-3 %	-3 %	-2.5°	-2.5°	-2.5°

At $T_A = 25\text{ }^\circ\text{C}$, at frequency = 60 Hz, $R_{br} = 4\ \Omega$, unless otherwise noted.

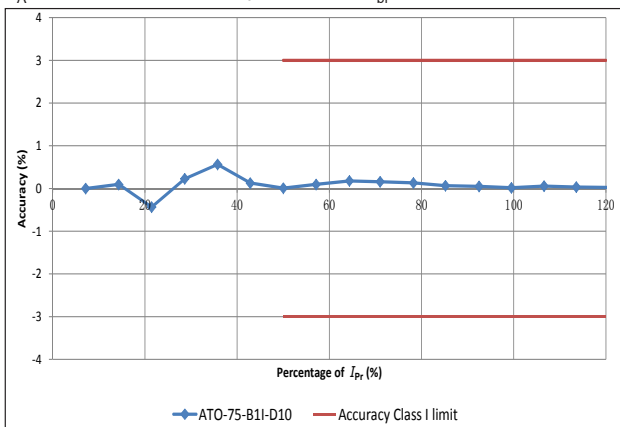

Figure 3: Accuracy vs. Percentage of I_{Pr}

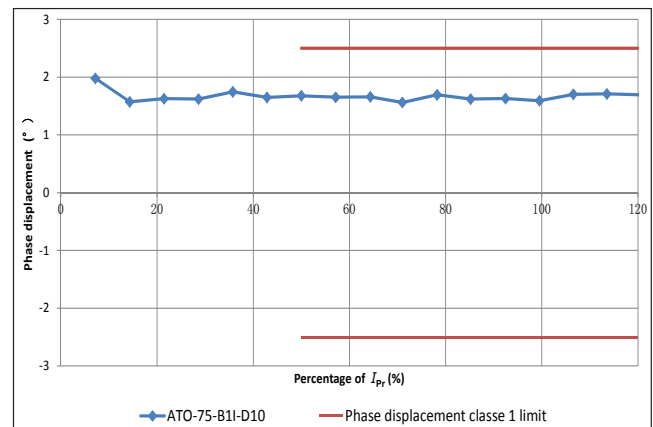

Figure 4: Phase displacement vs. Percentage of I_{Pr}

% of I_{Pr}	Ratio error			Phase displacement		
	50 %	100 %	120 %	50 %	100 %	120 %
Maximum	3 %	3 %	3 %	2.5°	2.5°	2.5°
Minimum	-3 %	-3 %	-3 %	-2.5°	-2.5°	-2.5°

Typical performance characteristics versus load resistance R_L

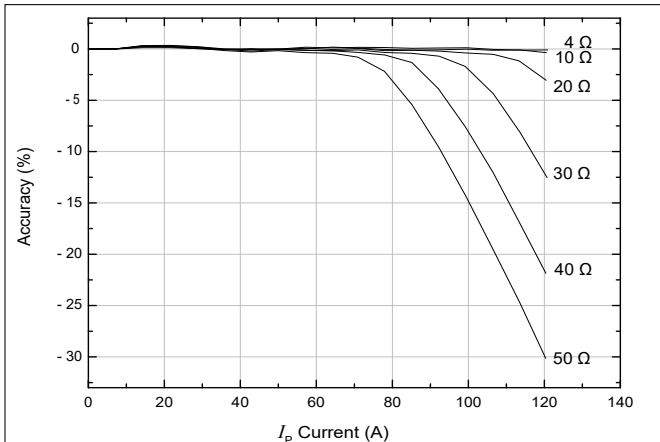

Figure 5: Accuracy vs. I_p Current @ 50 Hz

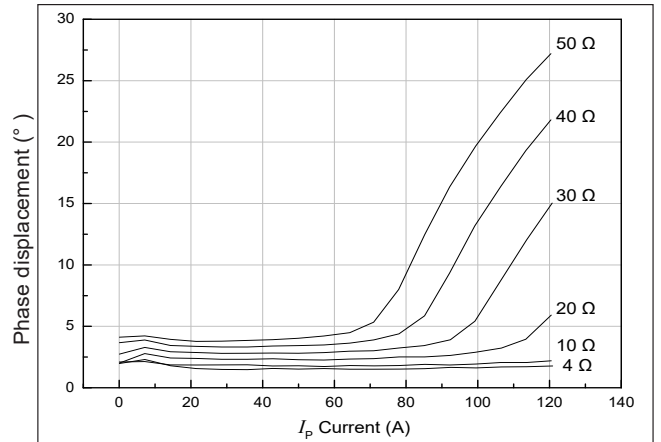

Figure 6: Phase displacement vs. I_p Current @ 50 Hz

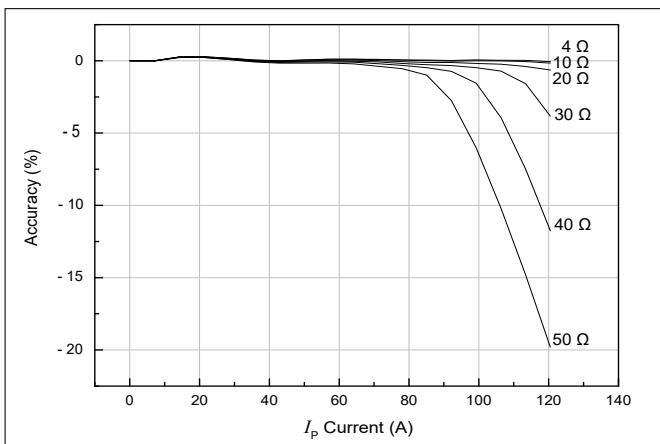

Figure 7: Accuracy vs. I_p Current @ 60 Hz

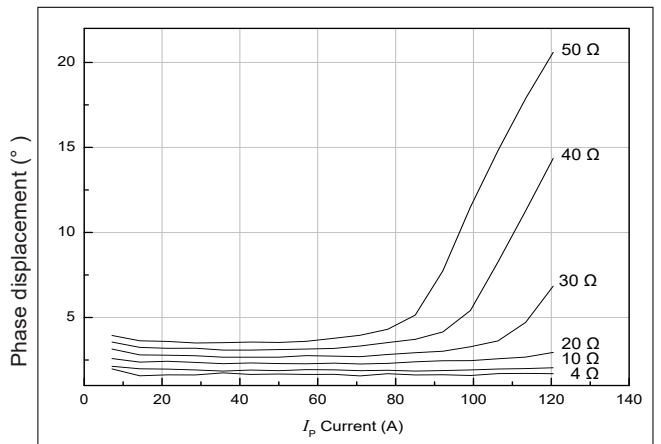

Figure 8: Phase displacement vs. I_p Current @ 60 Hz

Phase shift compensation capacitance with different load resistance and frequency

Load resistance (Ω)	50 Hz	60 Hz	Class 1 compliance
	Compensation capacitance (μF)	Compensation capacitance (μF)	
4.1	10 μF + 10 μF	10 μF + 4.7 μF	OK
5.6	10 μF + 4.7 μF	10 μF + 1 μF	OK
6.8	10 μF + 2.2 μF	6.8 μF + 2.2 μF	OK
7.5	10 μF + 2.2 μF	6.8 μF + 0.47 μF	OK
8.2	10 μF + 1 μF	6.8 μF + 1 μF	OK
9.1	10 μF	6.8 μF + 0.47 μF	OK
10	4.7 μF + 4.7 μF	6.8 μF	OK
12	6.8 μF + 1 μF	4.7 μF + 1 μF	OK
15	6.8 μF + 0.47 μF	4.7 μF + 0.22 μF	OK
20	4.7 μF + 1 μF	2.2 μF + 2.2 μF	OK

Performance parameters definition

Rated transformation ratio K_{ra}

Ratio of K_{ra} to the actual secondary voltage or current.

Ratio error ε

The current ratio error, expressed in per cent, is given by the formula:

$$\varepsilon = \frac{k_{ra} I_s - I_p}{I_p} \times 100 \%$$

Where:

K_{ra} : is the rated transformation ratio

I_p : is the actual primary current

I_s : is the actual secondary current when I_p is flowing, under the conditions of measurement

Phase displacement $\Delta\varphi$

The $\Delta\varphi$ is the difference in phase between the primary voltage or current and the secondary voltage or current phasors. The direction of the phasors being so chosen that the angle is zero for an ideal transformer.

The phase displacement is said to be positive when the secondary voltage or current phasors leads the primary voltage or current phasors.

Linearity error ε_L

The linearity error ε_L is the maximum positive or negative difference between the measured points and a corresponding linear regression line, expressed in % of I_{pr} .

Rated short-time thermal current I_{th}

Maximum value of the primary current which a transformer will withstand for a specified short time without suffering harmful effects, the secondary winding being short-circuited.

Rated dynamic current I_{dyn}

Maximum peak value of the primary current which a transformer will withstand, without being damaged electrically or mechanically by the resulting electromagnetic forces, the secondary winding being short-circuited.

ATO-75-B1I-D10 series: name and codification

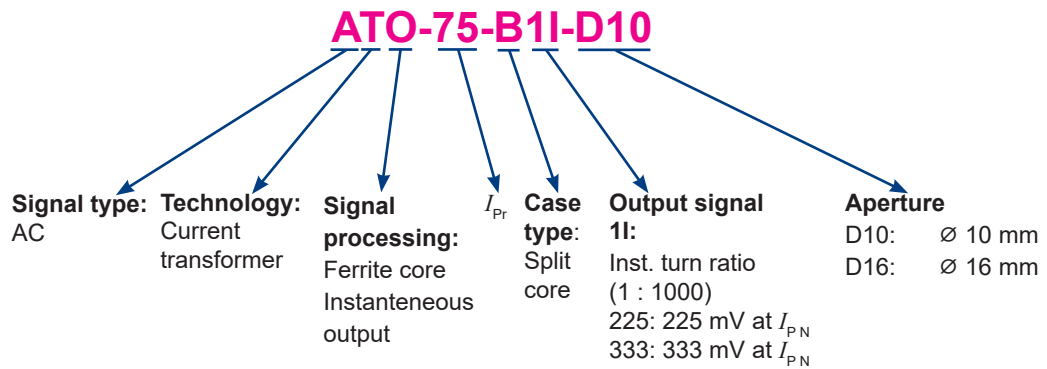

Dimensions (in mm)

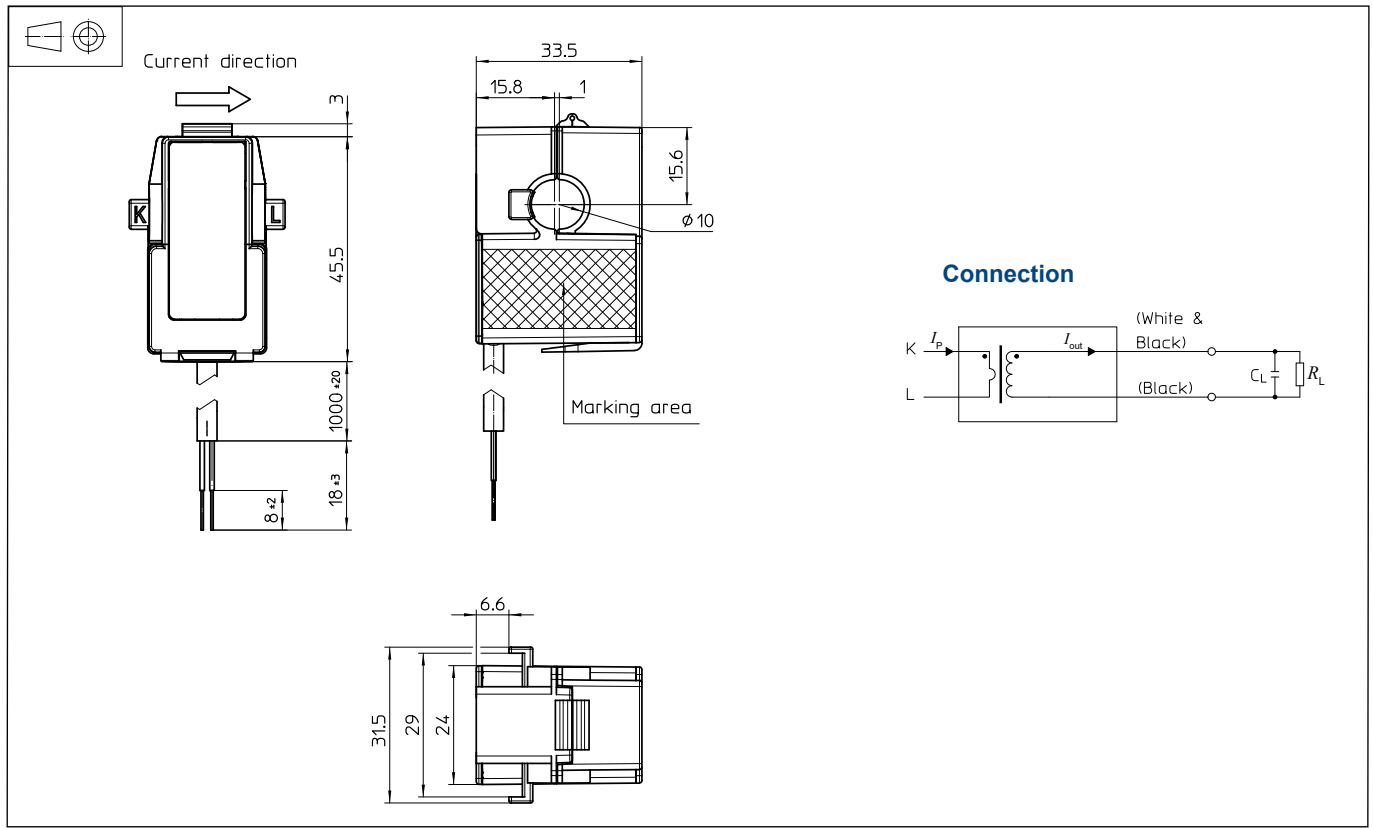

Mechanical characteristics

- General tolerance ± 0.5 mm
- Primary aperture $\varnothing 10$ mm
- Fastening Cable tie
- Output cable length 1 m

Remarks

- Attention: contact areas (air gap) must be kept clean (particle free) to ensure proper performance
- Installation of the transducer must be done unless otherwise specified on the datasheet, according to LEM Transducer Generic Mounting Rules. Please refer to LEM document N°ANE120504 available on our Web site: <https://www.lem.com/en/file/3137/download/>.

DIN RAIL ADAPTOR (additional part option) dimensions (in mm)

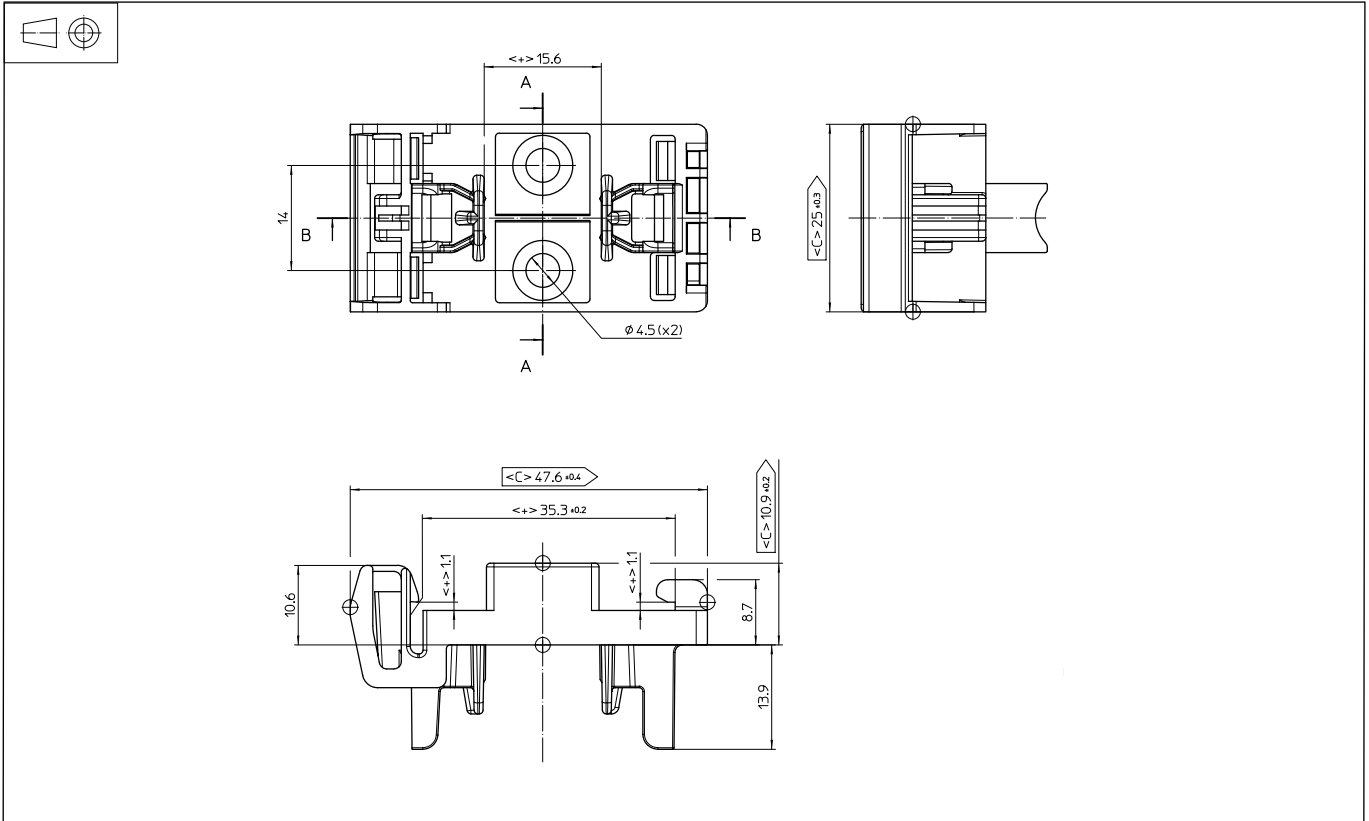

LEM Reference:70.C6.98.001.0

Mechanical characteristics

- General tolerance ± 0.4 mm
- Fastening 1.5 N·m

Remarks

- Attention: contact areas (air gap) must be kept clean (particle free) to ensure proper performance
- Installation of the transducer must be done unless otherwise specified on the datasheet, according to LEM Transducer Generic Mounting Rules. Please refer to LEM document N°ANE120504 available on our Web site:

<https://www.lem.com/en/file/3137/download/>.

单击下面可查看定价，库存，交付和生命周期等信息

[>>LEM\(莱姆\)](#)