

Voltage Transducer DVM series

$$U_{PN} = 600 \dots 1000 \text{ V}$$

Ref: DVM 600; DVM 1000

For the electronic measurement of voltage: DC, AC, pulsed..., with galvanic separation between the primary and the secondary circuit.



Features

- Bipolar and insulated measurement of voltage
- Current output
- Primary input and output connections with M5 threaded inserts
- Compatible with LV 100 family
- Built-in device.

Advantages

- Low consumption and low losses
- Compact design
- Very low sensitivity to common mode voltage variations
- Excellent accuracy (offset, sensitivity, linearity)
- Fast delay time
- Low temperature drift
- High immunity to external interferences.

Applications

- AC variable speed and servo motor drives
- Static converters for DC motor drives
- Battery supplied applications
- Uninterruptible Power Supplies (UPS)
- Switched Mode Power Supplies (SMPS)
- Power supplies for welding applications
- Renewable Energy (Solar and Wind)

- Single or three phase inverters
- Propulsion and braking choppers
- Propulsion converters
- Auxiliary converters
- High power drives
- Substations.

Standards

- EN 50155: 2021
- EN 50121-3-2: 2016
- EN 50124-1: 2017
- IEC 62497-1: 2010
- IEC 61010-1: 2010
- IEC 62477-1: 2012
- UL 347: 2016.

Application Domains

- Industrial
- Railway (fixed installations and onboard).

Note: ¹⁾ Except for DVM 600.

Safety



Caution

If the device is used in a way that is not specified by the manufacturer, the protection provided by the device may be compromised. Always inspect the electronics unit and connecting cable before using this product and do not use it if damaged. Mounting assembly shall guarantee the maximum primary conductor temperature, fulfill clearance and creepage distance, minimize electric and magnetic coupling, and unless otherwise specified can be mounted in any orientation.



Caution, risk of electrical shock

This transducer must be used in limited-energy secondary circuits SELV according to IEC 61010-1, in electric/electronic equipment with respect to applicable standards and safety requirements in accordance with the manufacturer's operating specifications.

Use caution during installation and use of this product; certain parts of the module can carry hazardous voltages and high currents (e.g. power supply, primary conductor).

Ignoring this warning can lead to injury and or/cause serious damage.

De-energize all circuits and hazardous live parts before installing the product.

All installations, maintenance, servicing operations and use must be carried out by trained and qualified personnel practicing applicable safety precautions.

This transducer is a build-in device, whose hazardous live parts must be inaccessible after installation.

This transducer must be mounted in a suitable end-enclosure.

Besides make sure to have a distance of minimum 30 mm between the primary terminals of the transducer and other neighboring components.

Main supply must be able to be disconnected.

Never connect or disconnect the external power supply while the primary circuit is connected to live parts.

Never connect the output to any equipment with a common mode voltage to earth greater than 30 V.

This transducer is a built-in device, not intended to be cleaned with any product. Nevertheless if the user must implement cleaning or washing process, validation of the cleaning program has to be done by himself.



ESD susceptibility

The product is susceptible to be damaged from an ESD event and the personnel should be grounded when handling it.

Do not dispose of this product as unsorted municipal waste. Contact a qualified recycler for disposal.



Underwriters Laboratory Inc. recognized component

Absolute maximum ratings

| Parameter | Symbol | Unit | Value |
|--|--|------|-----------------------------|
| Maximum DC supply voltage = ($U_p = 0$ V, 0.1 s) | $\pm \hat{U}_{C \max}$ | V | ± 33.6 |
| Maximum DC supply voltage = (working) (- 40 ... + 85 °C) | $\pm U_{C \max}$ | V | ± 26.4 |
| Electrostatic discharge voltage (HBM - Human Body Model) | $U_{ESD \text{ HBM}}$ | kV | 4 |
| Maximum DC common mode voltage | $U_{HV+} + U_{HV-}$ and $ U_{HV+} - U_{HV-} $ | kV | ≤ 6.3 $\leq U_{PM}$ |

Absolute maximum ratings apply at 25 °C unless otherwise noted.
 Stresses above these ratings may cause permanent damage.
 Exposure to absolute maximum ratings for extended periods may degrade reliability.

Environmental and mechanical characteristics

| Parameter | Symbol | Unit | Min | Typ | Max | Comment |
|--|--------------------|------|-----|------|--------------------|--|
| Ambient operating temperature | T_A | °C | -40 | | 85 | |
| Ambient storage temperature | $T_{A \text{ st}}$ | °C | -50 | | 90 | |
| Equipment operating temperature class | | | | | | EN 50155: OT6 |
| Switch-on extended operating temperature class | | | | | | EN 50155: ST0 |
| Rapid temperature variation class | | | | | | EN 50155: H1 |
| Conformal coating type | | | | | | EN 50155: PC2 |
| Relative humidity | RH | % | | | | Class 3K3 according to Table 1 of EN 60721-3-3 |
| Shock & vibration category and class | | | | | | EN 50155: 1B (EN 61373) |
| Mass | m | g | | 375 | | |
| Ingress protection rating | | | | IP40 | | IEC 60529 (Indoor use) |
| Pollution degree | | | | | PD4 | Insulation voltage accordingly |
| Altitude | | m | | | 2000 ¹⁾ | |
| Impact rating | | | | IK06 | | According to IEC 62262 |

RAMS data

| Parameter | Symbol | Unit | Min | Typ | Max | Comment |
|-------------------|-----------------|----------|-----|-----------|-----|---|
| Useful life class | | | | | | EN 50155: L4 |
| Mean failure rate | $\bar{\lambda}$ | h^{-1} | | 1/1827550 | | According to IEC 62380 $T_A = 45$ °C ON: 20 hrs/day ON/OFF: 320 cycles/year $U_C = \pm 24$ V , $U_p = 1000$ V |

Note: ¹⁾ Insulation coordination at 2000 m.

UL 347: Ratings and assumptions of certification

File # E315896 Volume: 1 Section: 3

Standards

- CSA C22.2 No. 253 Medium-Voltage AC Contactors, Controllers, and Control Centers
- UL 347 Standards for Safety for Medium-Voltage AC Contactors, Controllers, and Control Centers.

Conditions of acceptability

When installed in the end-use equipment, consideration shall be given to the following:

- 1 - *These devices must be mounted in a suitable end-use enclosure.*
- 2 - *The terminals have not been evaluated for field wiring.*
- 3 - *The rated Basic Insulation Level (BIL) is 20 kV for this device, after performing Impulse Withstand Tests. Additional testing will be required if a higher BIL rating is desired.*
- 4 - *The products have been evaluated for a maximum surrounding air temperature of 85 °C..*
- 5 - *Low voltage circuits are intended to be powered by a circuit derived from an isolating source (such as a transformer, optical isolator, limiting impedance or electro-mechanical relay) and having no direct connection back to the primary circuit (other than through the grounding means).*

Marking

Only those products bearing the UL or UR Mark should be considered to be Listed or Recognized and covered under UL's Follow-Up Service. Always look for the Mark on the product.

Remark

DVM 600 are not listed or recognized.

Insulation coordination

| Parameter | Symbol | Unit | ≤ Value | Comment |
|---|----------|------|---------|--------------------------|
| RMS voltage for AC insulation test, 50 Hz, 1 min | U_d | kV | 12 | |
| Impulse withstand voltage 1.2/50 μ s | U_{Ni} | kV | 30 | According to IEC 62497-1 |
| Partial discharge RMS test voltage ($q_m < 10$ pC) | U_t | V | 5000 | |
| Case material | - | - | V0 | |
| Comparative tracking index | CTI | | 600 | According to UL 94 |

Between primary and secondary

| | | | | |
|---|----------|----|------|--|
| Clearance | d_{Cl} | mm | 40 | Shortest distance through air |
| Creepage distance | d_{Cp} | mm | 61 | Shortest path along device body |
| Application example RMS voltage line-to-neutral | | V | 1000 | Reinforced insulation according to IEC 60664-1, IEC 61010-1 or IEC 62477-1 CAT III, PD2 |
| Application example System voltage RMS | | V | 3600 | Basic insulation according to IEC 61800-5-1 CAT III, PD2 |
| Application example Rated insulation RMS voltage | U_{Nm} | V | 3700 | Basic insulation according to IEC 62497-1 CAT III, PD2, Rolling stock |
| Application example Rated insulation RMS voltage | U_{Nm} | V | 3000 | Reinforced insulation according to IEC 62479-1 CAT II, PD2 |

Between primary and ground (fastening screw M6 head)

| | | | | |
|---|----------|----|------|--|
| Clearance | d_{Cl} | mm | 41 | Shortest distance through air |
| Creepage distance | d_{Cp} | mm | 63 | Shortest path along device body |
| Application example Rated insulation RMS voltage | | V | 1000 | Reinforced insulation according to IEC 61010-1 CAT III, PD2 |

Between secondary and ground (fastening screw M6 head)

| | | | | |
|---|----------|----|------|---|
| Clearance | d_{Cl} | mm | 16 | Shortest distance through air |
| Creepage distance | d_{Cp} | mm | 29 | Shortest path along device body |
| Application example Rated insulation RMS voltage | | V | 1000 | Basic insulation according to IEC 61010-1 CAT III, PD2 |

Electrical data DVM 600

 At $T_A = T_{A\min} \dots T_{A\max}$, $\pm U_C = \pm 24$ V, $R_M = 100 \Omega$, unless otherwise noted (see Min, Max, typ, definition paragraph in [page 8](#)).

| Parameter | Symbol | Unit | Min | Typ | Max | Comment |
|---|------------------|---------------|------------|-----------------------|------------|--|
| Primary nominal DC voltage (continuous) | U_{PNDC} | V | | 600 | | |
| Primary nominal AC RMS voltage (continuous) | U_{PNAC} | V | | 600 | | |
| Primary voltage, measuring range | U_{PM} | V | -900 | | 900 | |
| Measuring resistance | R_M | Ω | 0 | | | see derating on figure 1 |
| Secondary current | I_S | mA | | 50 | | @ U_{PNDC} |
| DC supply voltage = | U_C | V | ± 10.8 | $\pm 12 \dots \pm 24$ | ± 26.4 | Tolerance ± 10 % on Typ value |
| DC current consumption = | I_C | mA | | 30 | | @ $U_C = \pm 24$ V at $U_p = 0$ V |
| | | | | 40 | | @ $U_C = \pm 15$ V at $U_p = 0$ V |
| Power consumption $U_p = 0$ V @ U_C | P_C | W | | 1.44 | | @ $U_C = \pm 24$ V |
| Power consumption $U_p = U_{PNDC}$ @ U_C | P_C | W | | 2.64 | | @ $U_C = \pm 24$ V |
| Inrush current | | | | | | NA (EN 50155) |
| Interruptions on power supply voltage class | | | | | | NA (EN 50155) |
| Supply change-over class | | | | | | NA (EN 50155) |
| Rise time of U_C (10 % ... 90 %) | t_{rise} | ms | | | 100 | |
| Total error | ϵ_{tot} | % | -1 | | 1 | |
| Total error | ϵ_{tot} | % | -0.5 | | 0.5 | @ 25 °C 100 % tested in production |
| Temperature variation of U_{OE} referred to primary | U_{OET} | V | -1.44 | | 1.44 | |
| | | | -1.20 | | 1.20 | @ 25 °C ... 85 °C |
| Electrical Offset voltage referred to primary | U_{OE} | V | -0.6 | | 0.6 | @ 25 °C 100 % tested in production |
| Sensitivity | S | $\mu A/V$ | | 83.33 | | @ 25 °C |
| Sensitivity error | ϵ_S | % | -0.3 | | 0.3 | @ 25 °C |
| Temperature variation of sensitivity error | ϵ_{ST} | % | -0.5 | | 0.5 | referred to 25 °C |
| Linearity error | ϵ_L | % of U_{PN} | -0.5 | | 0.5 | @ 25 °C ± 900 V range |
| RMS noise current 100 Hz ... 100 kHz referred to secondary | I_{no} | μA | | 30 | | @ 25 °C |
| Delay time @ 10 % of the final output value for U_{PN} step | t_{D10} | μs | | 30 | | |
| Delay time @ 90 % of the final output value for U_{PN} step | t_{D90} | μs | | 50 | 60 | 0 to 600 V step, 6 kV/ μs |
| Frequency bandwidth | BW | kHz | | 12.8 | | -3 dB |
| | | | | 8 | | -1 dB |
| Start-up time | t_{start} | ms | | 190 | 250 | |
| Resistance of primary | R_p | M Ω | | 5.5 | | |
| Total primary power loss @ U_{PN} | P_p | W | | 0.07 | | |

Electrical data DVM 1000

 At $T_A = T_{A \min} \dots T_{A \max}$, $\pm U_C = \pm 24 \text{ V}$, $R_M = 100 \Omega$, unless otherwise noted (see Min, Max, typ, definition paragraph in [page 8](#)).

| Parameter | Symbol | Unit | Min | Typ | Max | Comment |
|---|------------------|-----------------|------------|-----------------------|------------|---|
| Primary nominal DC voltage (continuous) | U_{PNDC} | V | | 1000 | | |
| Primary nominal AC RMS voltage (continuous) | U_{PNAC} | V | | 1000 | | |
| Primary voltage, measuring range | U_{PM} | V | -1500 | | 1500 | |
| Measuring resistance | R_M | Ω | 0 | | | see derating on figure 1 |
| Secondary current | I_S | mA | | 50 | | @ U_{PNDC} |
| DC supply voltage = | U_C | V | ± 10.8 | $\pm 12 \dots \pm 24$ | ± 26.4 | Tolerance $\pm 10 \%$ on Typ value |
| DC current consumption = | I_C | mA | | 30 | | @ $U_C = \pm 24 \text{ V}$ at $U_p = 0 \text{ V}$ |
| | | | | 40 | | @ $U_C = \pm 15 \text{ V}$ at $U_p = 0 \text{ V}$ |
| Power consumption $U_p = 0 \text{ V}$ @ U_C | P_C | W | | 1.44 | | @ $U_C = \pm 24 \text{ V}$ |
| Power consumption $U_p = U_{PNDC}$ @ U_C | P_C | W | | 2.64 | | @ $U_C = \pm 24 \text{ V}$ |
| Inrush current | | | | | | NA (EN 50155) |
| Interruptions on power supply voltage class | | | | | | NA (EN 50155) |
| Supply change-over class | | | | | | NA (EN 50155) |
| Rise time of U_C (10 % ... 90 %) | t_{rise} | ms | | | 100 | |
| Total error | ϵ_{tot} | % | -1 | | 1 | |
| Total error | ϵ_{tot} | % | -0.5 | | 0.5 | @ 25 °C 100 % tested in production |
| | | | | -2.4 | | 2.4 |
| Temperature variation of U_{OE} referred to primary | U_{OET} | V | | | | @ 25 °C ... 85 °C |
| | | | | -2.0 | | 2.0 |
| Electrical Offset voltage referred to primary | U_{OE} | V | -1.0 | | 1.0 | @ 25 °C 100 % tested in production |
| Sensitivity | S | $\mu\text{A/V}$ | | 50 | | @ 25 °C |
| Sensitivity error | ϵ_S | % | -0.3 | | 0.3 | @ 25 °C |
| Temperature variation of sensitivity error | ϵ_{ST} | % | -0.5 | | 0.5 | referred to 25 °C |
| Linearity error | ϵ_L | % of U_{PN} | -0.5 | | 0.5 | @ 25 °C $\pm 1500 \text{ V}$ range |
| RMS noise current 100 Hz ... 100 kHz referred to secondary | I_{no} | μA | | 30 | | @ 25 °C |
| Delay time @ 10 % of the final output value for U_{PN} step | t_{D10} | μs | | 30 | | |
| Delay time @ 90 % of the final output value for U_{PN} step | t_{D90} | μs | | 50 | 60 | 0 to 1000 V step, 6 kV/ μs |
| Frequency bandwidth | BW | kHz | | 12.8 | | -3 dB |
| | | | | 8 | | -1 dB |
| Start-up time | t_{start} | ms | | 190 | 250 | |
| Resistance of primary | R_p | M Ω | | 5.5 | | |
| Total primary power loss @ U_{PN} | P_p | W | | 0.18 | | |

Definition of typical, minimum and maximum values

Minimum and maximum values for specified limiting and safety conditions have to be understood as such as well as values shown in “typical” graphs.

On the other hand, measured values are part of a statistical distribution that can be specified by an interval with upper and lower limits and a probability for measured values to lie within this interval.

Unless otherwise stated (e.g. “100 % tested”), the LEM definition for such intervals designated with “min” and “max” is that the probability for values of samples to lie in this interval is 99.73 %.

For a normal (Gaussian) distribution, this corresponds to an interval between -3 sigma and $+3$ sigma. If “typical” values are not obviously mean or average values, those values are defined to delimit intervals with a probability of 68.27 %, corresponding to an interval between $-\text{sigma}$ and $+\text{sigma}$ for a normal distribution.

Typical, maximal and minimal values are determined during the initial characterization of the product.

Typical performance characteristics

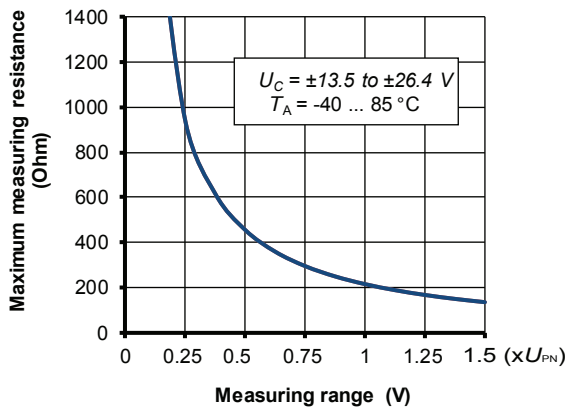

Figure 1: Maximum measuring resistance

$$R_{M,max} = \min \left(\frac{0.02 \times U_{PN} \times (U_C - 1.4) \times 10^3}{U_p} - 25; \frac{0.24 \times U_{PN} \times 10^3}{U_p} - 25 \right) \Omega$$

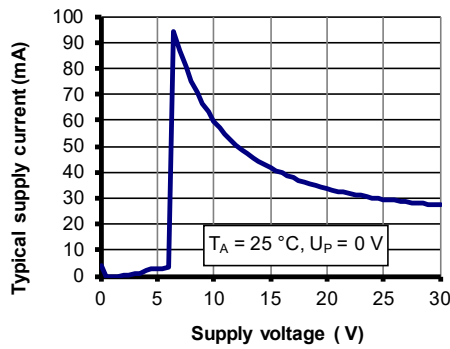

Figure 2: Supply current function of supply voltage

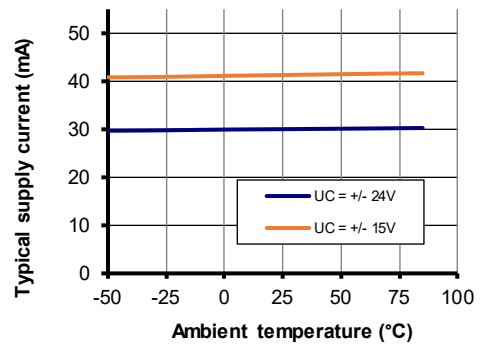

Figure 3: Supply current function of temperature

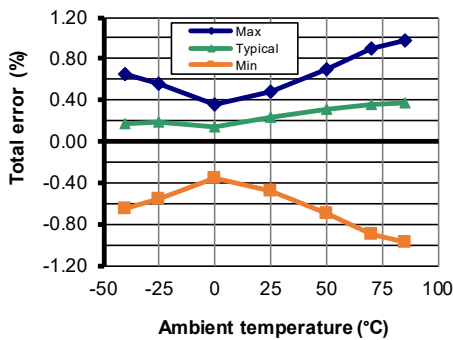

Figure 4: Total error in temperature

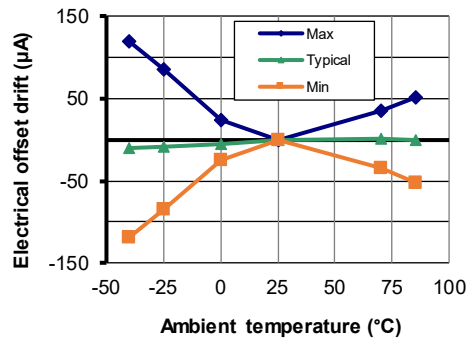

Figure 5: Electrical offset thermal drift

Typical performance characteristics

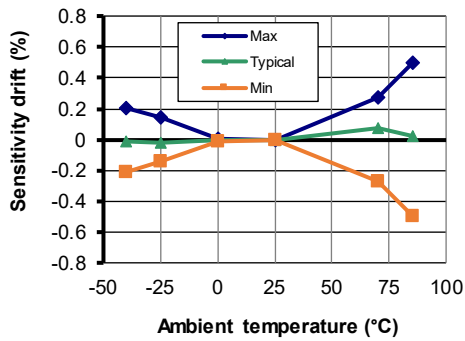

Figure 6: Sensitivity thermal drift

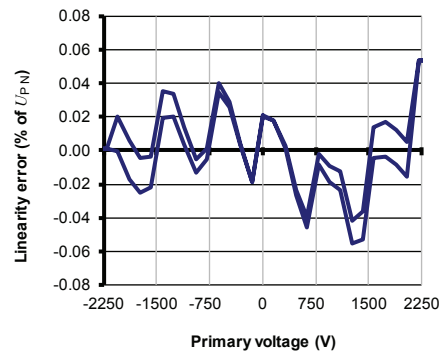

Figure 7: Typical linearity error at 25 °C

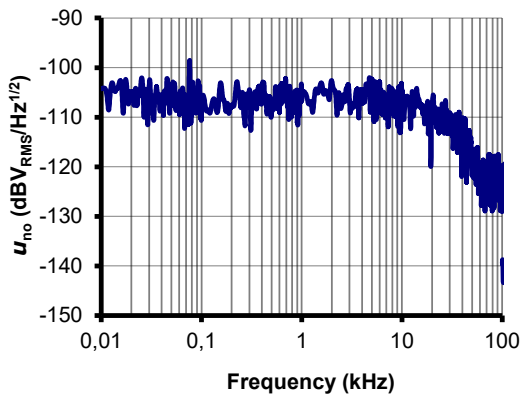

Figure 8: Typical output noise voltage spectral density u_{no} referred to secondary with $R_M = 50 \Omega$

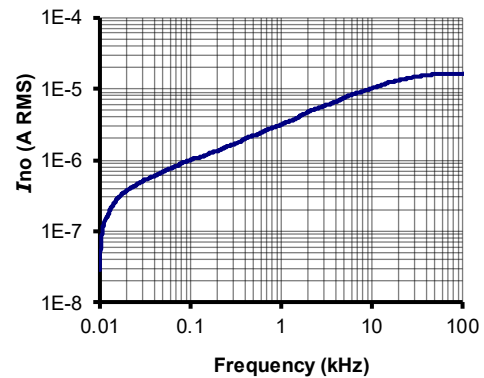

Figure 9: Typical total output RMS noise current I_{no} referred to secondary with $R_M = 50 \Omega$

Figure 8 (output noise voltage spectral density) shows that there are no significant discrete frequencies in the output. Figure 9 confirms the absence of steps in the total output RMS noise current that would indicate discrete frequencies. To calculate the total output RMS noise in a frequency band f_1 to f_2 , the formula is:
with $I_{no}(f)$ read from figure 9 (typical, RMS value).

$$I_{no}(f_1 \text{ to } f_2) = \sqrt{I_{no}(f_2)^2 - I_{no}(f_1)^2}$$

Example:

What is the total output RMS noise from 100 to 1 kHz?
Figure 9 gives $I_{no}(100 \text{ Hz}) = 1.0 \mu\text{A}$ and $I_{no}(1 \text{ kHz}) = 3.13 \mu\text{A}$.

$$\sqrt{(3.13 \times 10^{-6})^2 - (1.0 \times 10^{-6})^2} = 2.97 \mu\text{A}$$

Therefore, the total output RMS noise current is 2.97 μA .

Typical performance characteristics

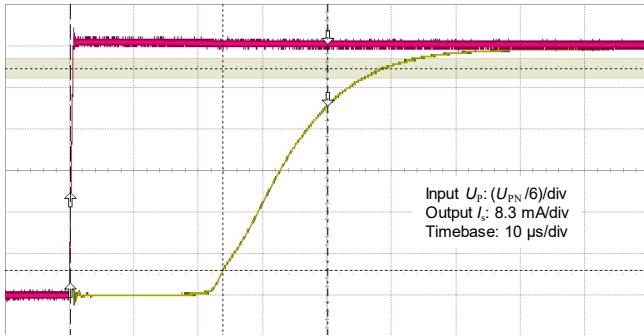

Figure 10: Typical step response (0 to U_{PN})

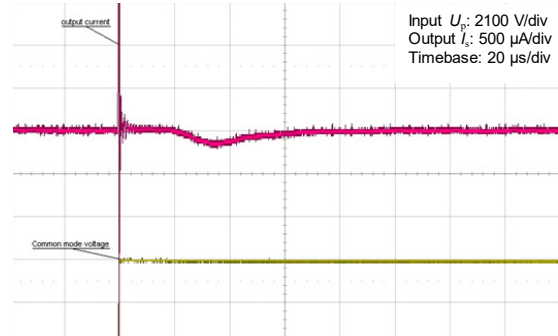

Figure 11: Detail of typical common mode perturbation (4200 V step with $6 \text{ kV}/\mu\text{s}$, $R_M = 100 \Omega$)

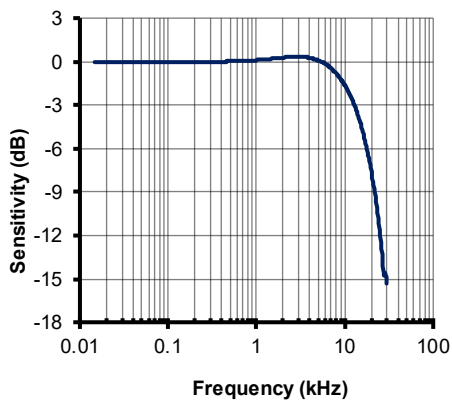

Figure 12: Sensitivity function of frequency

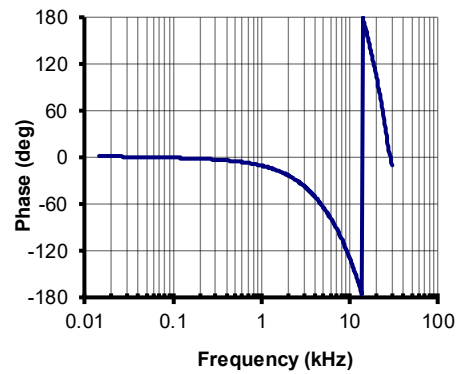

Figure 13: Phase shift function of frequency

Terms and definitions

Simplified transducer model

The static model of the transducer with current output at temperature T_A is:

$$I_S = S \cdot U_P \cdot (1 + \varepsilon)$$

In which (referred to primary):

$$\varepsilon \cdot U_P = U_{OE} + U_{OT} + \varepsilon_s \cdot U_P + \varepsilon_{sT} \cdot U_P + \varepsilon_L(U_{Pmax}) \cdot U_{Pmax}$$

- U_P : primary voltage (V)
- U_{Pmax} : maximum primary voltage applied to the transducer (V)
- I_S : secondary current (A)
- S : sensitivity of the transducer
- TCS : temperature coefficient of S
- T_A : ambient operating temperature (°C)
- U_{OE} : electrical offset voltage (V)
- U_{OT} : temperature variation of U_{OE} (V)
- ε_s : sensitivity error at 25 °C
- ε_{sT} : thermal drift of S
- $\varepsilon_L(U_{Pmax})$: linearity error for U_{Pmax}

This model is valid for primary voltage U_P between $-U_{Pmax}$ and $+U_{Pmax}$ only.

This is the absolute maximum error. As all errors are independent, a more realistic way to calculate the error would be to use the following formula:

$$\varepsilon = \sqrt{\sum_{i=1}^N \varepsilon_i^2}$$

Total error referred to primary

The total error ε_{tot} is the error at $\pm U_{PN}$, relative to the rated value U_{PN} .

It includes all errors mentioned above

- the electrical offset U_{OE}
- the sensitivity error ε_s
- the linearity error ε_L (to U_{PN}).

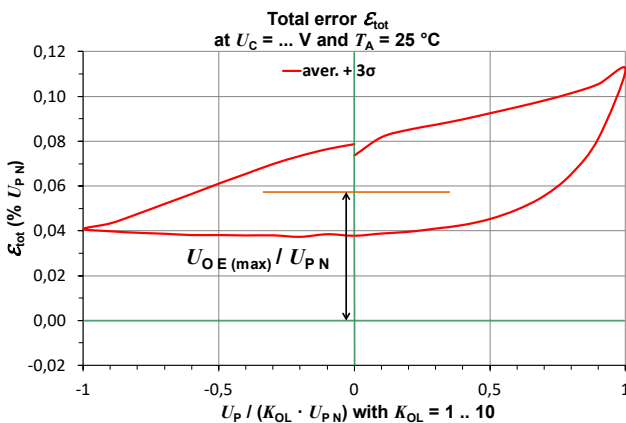
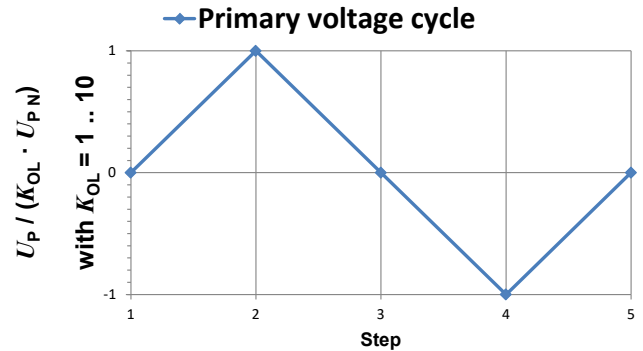

Figure 14: Total error ε_{tot}

Electrical offset referred to primary



K_{OL} : Overload factor

Figure 15: voltage cycle used to measure the electrical offset (transducer supplied)

Using the voltage cycle shown in previous figure, the electrical offset voltage U_{OE} is the residual output referred to primary when the input voltage is zero.

The temperature variation U_{OT} of the electrical offset voltage

$$U_{OE} = \frac{U_{P(3)} + U_{P(5)}}{2}$$

U_{OT} is the variation of the electrical offset from 25 °C to the considered temperature.

$$U_{OT}(T) = U_{OE}(T) - U_{OE}(25^\circ\text{C})$$

Sensitivity and linearity

To measure sensitivity and linearity, the primary voltage (DC) is cycled from 0 to U_P , then to $-U_P$ and back to 0 (equally spaced $U_P/10$ steps). The sensitivity S is defined as the slope of the linear regression line for a cycle between $\pm U_{PN}$.

The linearity error ε_L is the maximum positive or negative difference between the measured points and the linear regression line, expressed in % of U_{PN} .

Delay times

The delay time t_{D10} @ 10 % and the delay time t_{D90} @ 90 % with respect to the primary are shown in the next figure.

Both slightly depend on the primary current di/dt . They are measured at nominal current.

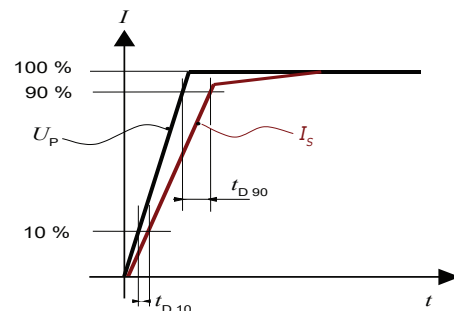
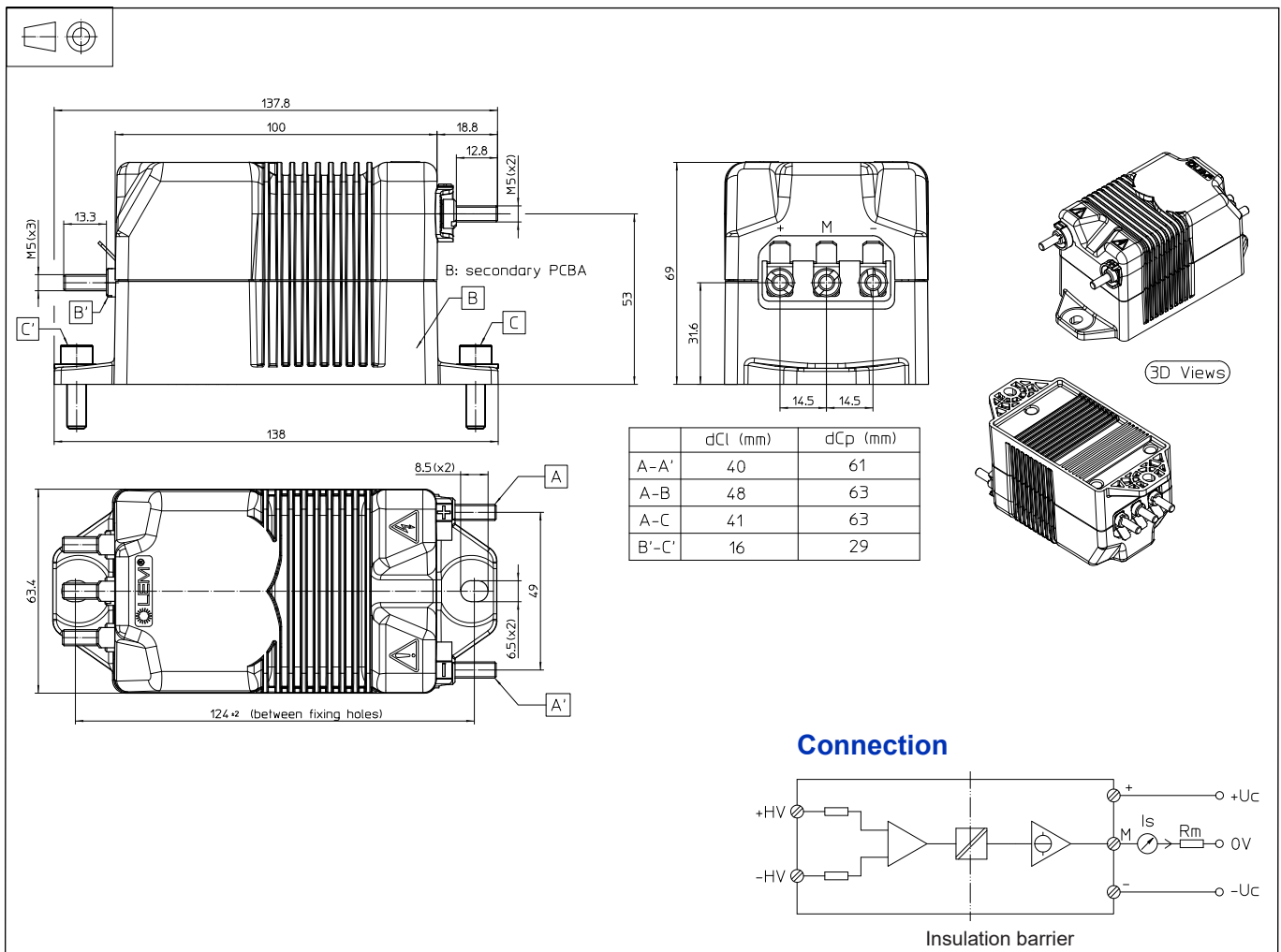

Figure 15: Delay time t_{D10} @ 10 % and delay time t_{D90} @ 90 %.

Dimensions (in mm)

Mechanical characteristics

- General tolerance ± 1 mm
- Transducer fastening 2 holes $\varnothing 6.5$ mm
2 M6 steel screws
Recommended fastening torque 5 N·m ± 10 %
- Connection of primary 2 M5 threaded studs
Recommended fastening torque 2.2 N·m ± 10 %
- Connection of secondary 3 M5 threaded studs
Recommended fastening torque 2.2 N·m ± 10 %

Remarks

- I_s is positive when $U_{HV+} - U_{HV-} > 0$ V
- The secondary cables also have to be routed together all the way.
- Installation of the transducer must be done unless otherwise specified on the datasheet, according to LEM Transducer Generic Mounting Rules. Please refer to LEM document N°ANE120504 available on our Web site: <https://www.lem.com/en/file/3137/download/>

Note: Additional information available on request.

单击下面可查看定价，库存，交付和生命周期等信息

[>>LEM\(莱姆\)](#)