

AUTOMOTIVE CURRENT TRANSDUCER OPEN LOOP TECHNOLOGY

HAH3DR 800-S07/SP3, HAH3DR 900-S07/SP3, HAH3DR 1000-S07/SP3, HAH3DR 1100-S07/SP3, HAH3DR 1200-S07/SP3

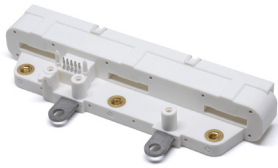

Introduction

The HAH3DR-S07 family is a tri-phase transducer for DC, AC, or pulsed currents measurement in automotive applications. It offers a galvanic separation between the primary circuit (high power) and the secondary circuit (electronic circuit).

Features

- Open Loop transducer using the Hall effect sensor
- Low voltage application
- Unipolar +5 V DC power supply
- Primary current measuring range up to ± 1200 A
- Maximum RMS primary admissible current: defined by the busbar, the magnetic core or ASIC $T < +125$ °C
- Operating temperature range: -40 °C $< T < +125$ °C
- Output voltage fully ratiometric (in sensitivity and offset).

Special features

- All in one tri-phase transducer
- Perfect fit to Infineon IGBT
- Simplified installation with press fit contacts eliminates soldering
- Built-in nuts for busbar attachment.

Advantages

- Excellent accuracy
- Very good linearity
- Very low thermal offset drift
- Very low thermal sensitivity drift
- High frequency bandwidth
- No insertion losses
- Very fast delay time.

Automotive applications

- Starter Generators
- Inverters
- HEV applications
- EV applications
- DC / DC converter.

Principle of HAH3DR S07 family

The open loop transducers uses a Hall effect integrated circuit. The magnetic flux density B , contributing to the rise of the Hall voltage, is generated by the primary current I_p to be measured. The current to be measured I_p is supplied by a current source i.e. battery or generator (Figure 1).

Within the linear region of the hysteresis cycle, B is proportional to:

$$B(I_p) = a \times I_p$$

The Hall voltage is thus expressed by:

$$U_{Hall} = (c_{Hall} / d) \times I_{Hall} \times a \times I_p$$

Except for I_p , all terms of this equation are constant. Therefore:

$$U_{Hall} = b \times I_p$$

a constant

b constant

c_{Hall} Hall coefficient

d thickness of the Hall plate

I_{Hall} current across the Hall plates

The measurement signal U_{Hall} amplified to supply the user output voltage or current.

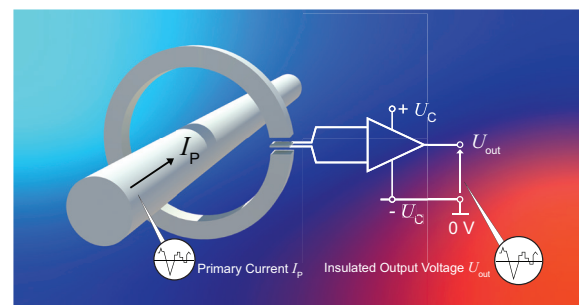
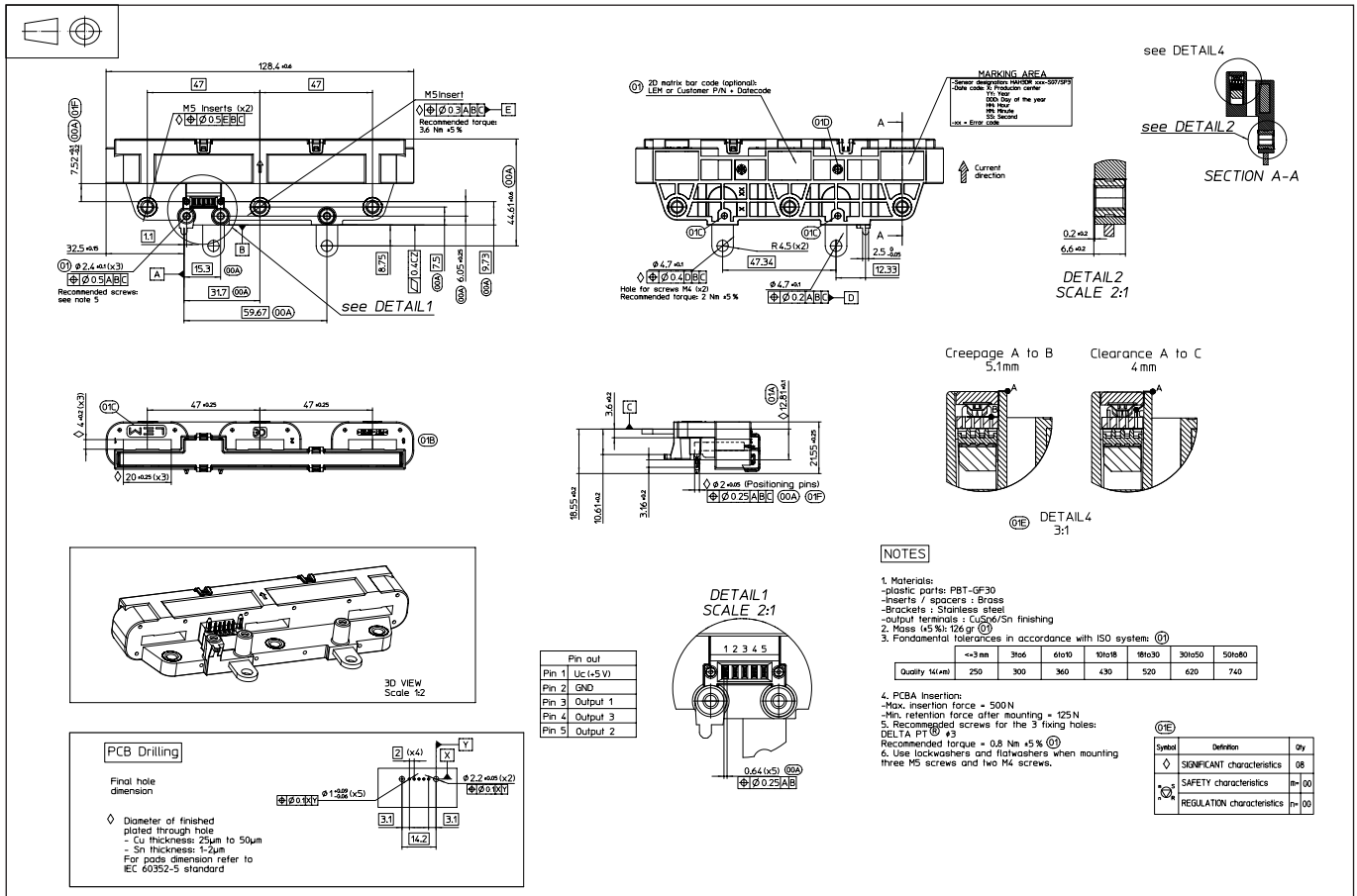

Fig. 1: Principle of the open loop transducer.

Dimensions (in mm)



Mechanical characteristics

- Materials: PBT-GF 30
- Magnetic core: FeSi wound core
- Pins: CuSn 6 /Sn finishing
- Mass: 126 g $\pm 5\%$

Mounting recommendation (Shown as page 3)

- PCBA insertion:
 - Max. insertion force for 5 press fit pins = 500 N
 - Min. retention force after mounting = 125 N
 - Max. insertion force for plastic bosses = 1500 N
- Recommended 3 fasteners for plastic:
 - DELTA PT $\phi 3$ wn 5451, torque = 0.8 N·m $\pm 5\%$
- Recommended M5 screws:
 - L = 10 mm, torque: 3.6 N·m $\pm 5\%$
- Recommended M4 screws:
 - L = 14 mm, torque: 2 N·m $\pm 5\%$
- Use both lockwashers and flatwashers when mounting three M5 screws and two screws.

Remark

$U_{out} > U_o$ when I_p flows in the positive direction (see arrow on drawing).

System architecture (example)

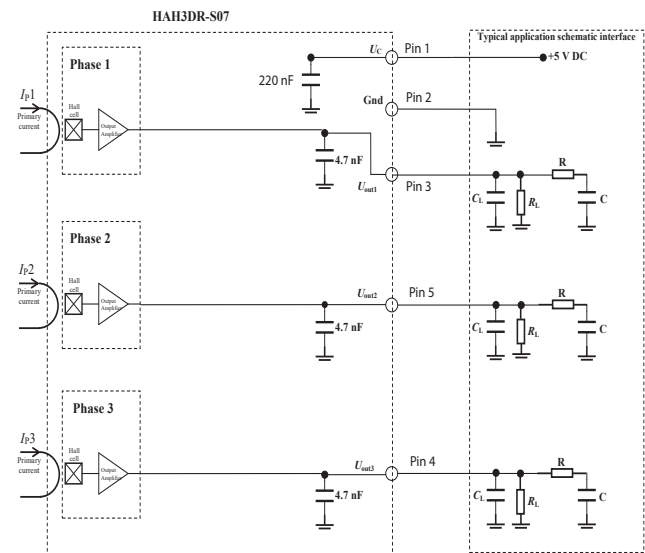

$C_1 < 2.2$ nF EMC protection (optional)
RC Low pass filter (optional)

On board diagnostic

$R_L > 10$ k Ω Resistor for signal line diagnostic (optional)

Mounting Operation and Recommendations

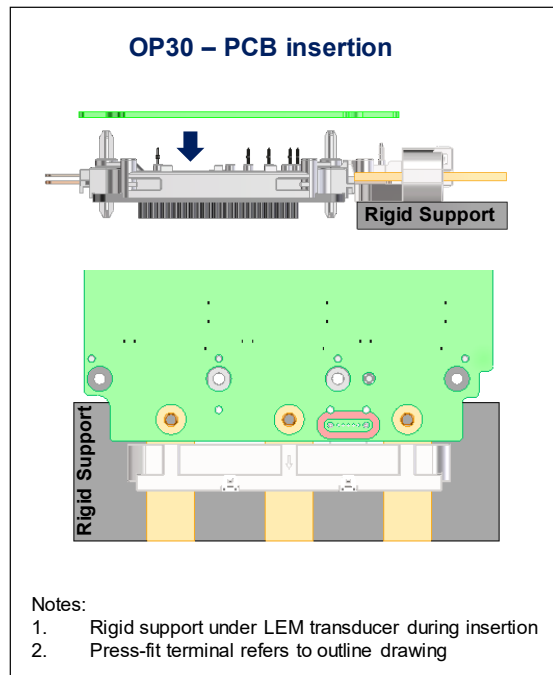
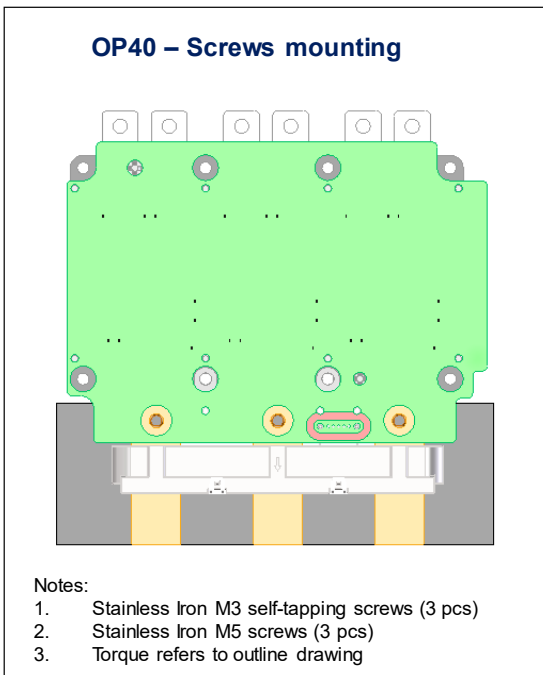
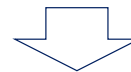
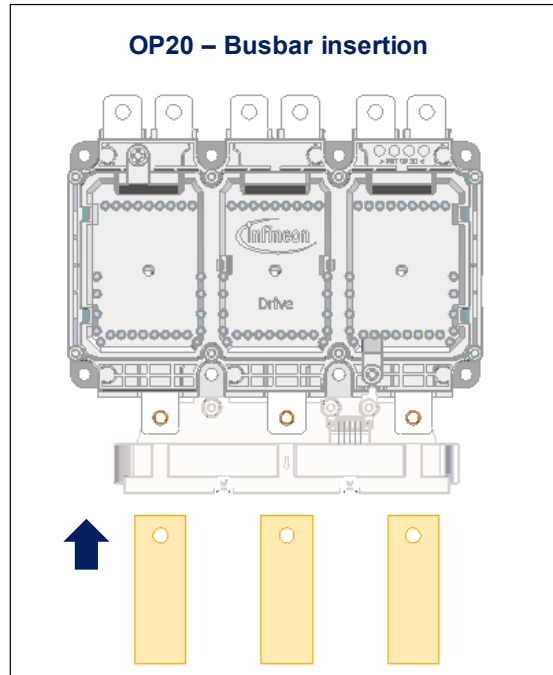
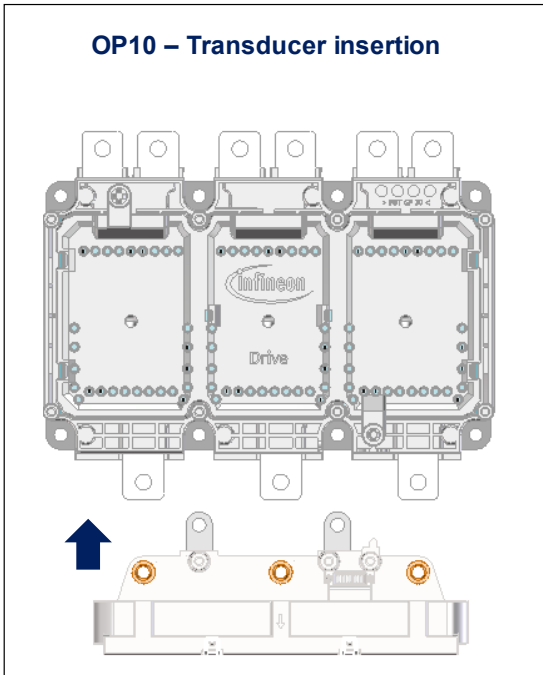

Absolute ratings (not operating)

Parameter	Symbol	Unit	Specification			Conditions
			Min	Typical	Max	
Maximum supply voltage	$U_{C\max}$	V	-0.5		8	Continuous not operating
					6.5	Exceeding this voltage may temporarily reconfigure the circuit until the next power on
Ambient storage temperature	$T_{A\text{st}}$	°C	-40		125	
Electrostatic discharge voltage	$U_{\text{ESD HBM}}$	kV			8	IEC 61000-4-2
RMS voltage for AC insulation test	U_d	kV			2.5	50 Hz, 1 min, IEC 60664 part 1
Creepage distance	d_{CP}	mm	5.1			
Clearance	d_{Cl}	mm	4			
Comparative tracking index	CTI		PLC 3			
Insulation resistance	R_{INS}	MΩ	500			500 V DC, ISO 16750

Operating characteristics

All characteristics noted under conditions $-I_{\text{PM}} \leq I_{\text{P}} \leq I_{\text{PM}}$, $4.75 \text{ V} \leq U_{\text{C}} \leq 5.25 \text{ V}$, $-40 \text{ °C} \leq T_{\text{A}} \leq 125 \text{ °C}$, unless otherwise noted.

Parameter	Symbol	Unit	Specification			Conditions
			Min	Typical	Max	
Electrical Data						
Supply voltage ¹⁾	U_{C}	V	4.75	5	5.25	
Ambient operating temperature	T_{A}	°C	-40		125	
Output voltage (Analog)	U_{out}	V	$U_{\text{out}} = (U_{\text{C}}/5) \times (U_{\text{O}} + S \times I_{\text{P}})$			@ $T_{\text{A}} = 25 \text{ °C}$
Offset voltage	U_{O}	V		2.5		
Current consumption	I_{C}	mA		45	60	@ $U_{\text{C}} = 5 \text{ V}$
Load resistance	R_{L}	KΩ	10			
Output internal resistance	R_{out}	Ω		1	10	DC to 1 kHz
Performance Data						
Ratiometricity error	ε_{r}	%		±0.5		
Sensitivity error	ε_{S}	%		±1		@ $T_{\text{A}} = 25 \text{ °C}$, @ $U_{\text{C}} = 5 \text{ V}$
Electrical offset voltage	U_{OE}	mV		±2		@ $T_{\text{A}} = 25 \text{ °C}$, @ $U_{\text{C}} = 5 \text{ V}$
Magnetic offset voltage	U_{OM}	mV		±2		@ $T_{\text{A}} = 25 \text{ °C}$, @ $U_{\text{C}} = 5 \text{ V}$, after $\pm I_{\text{PM}}$
Average temperature coefficient of U_{OE}	$TCU_{\text{OEA V}}$	mV/°C		±0.04		
Average temperature coefficient of S	TCS_{AV}	%/°C		±0.02		
Linearity error	ε_{L}	%	-0.5		0.5	% of Full range, $-800 \text{ A} < I_{\text{P}} < 800 \text{ A}$
			-2		2	% of Full range, $800 \text{ A} < I_{\text{P}} < 1200 \text{ A}$
Delay time to 90 % to the final output value for I_{PN} step	$t_{\text{D}90}$	μs		2	6	$di/dt = 100 \text{ A}/\mu\text{s}$
Frequency bandwidth ²⁾	BW	kHz	40			@ -3 dB
Peak-to-peak noise voltage	$U_{\text{no pp}}$	mV			20	@ DC to 1 MHz
Phase shift	$\Delta\varphi$	°	-4			@ DC to 1 kHz

Notes: ¹⁾ The output voltage U_{out} is fully ratiometric. The offset and sensitivity are dependent on the supply voltage U_{C} relative to the following formula:

$$I_{\text{P}} = \left(\frac{5}{U_{\text{C}}} \times U_{\text{out}} - U_{\text{O}} \right) \times \frac{1}{S} \text{ with } S \text{ in (V/A)}$$

²⁾ Primary current frequencies must be limited in order to avoid excessive heating of the busbar, magnetic core and the ASIC (see feature paragraph in page 1).

HAH3DR 800-S07/SP3

Parameter	Symbol	Unit	Specification			Conditions
			Min	Typical	Max	
Electrical Data						
Primary current, measuring range	I_{PM}	A	-800		800	
Sensitivity	S	mV/A		2.50		

HAH3DR 900-S07/SP3

Parameter	Symbol	Unit	Specification			Conditions
			Min	Typical	Max	
Electrical Data						
Primary current, measuring range	I_{PM}	A	-900		900	
Sensitivity	S	mV/A		2.22		

HAH3DR 1000-S07/SP3

Parameter	Symbol	Unit	Specification			Conditions
			Min	Typical	Max	
Electrical Data						
Primary current, measuring range	I_{PM}	A	-1000		1000	
Sensitivity	S	mV/A		2.00		

HAH3DR 1100-S07/SP3

Parameter	Symbol	Unit	Specification			Conditions
			Min	Typical	Max	
Electrical Data						
Primary current, measuring range	I_{PM}	A	-1100		1100	
Sensitivity	S	mV/A		1.82		

HAH3DR 1200-S07/SP3

Parameter	Symbol	Unit	Specification			Conditions
			Min	Typical	Max	
Electrical Data						
Primary current, measuring range	I_{PM}	A	-1200		1200	
Sensitivity	S	mV/A		1.67		

Total error

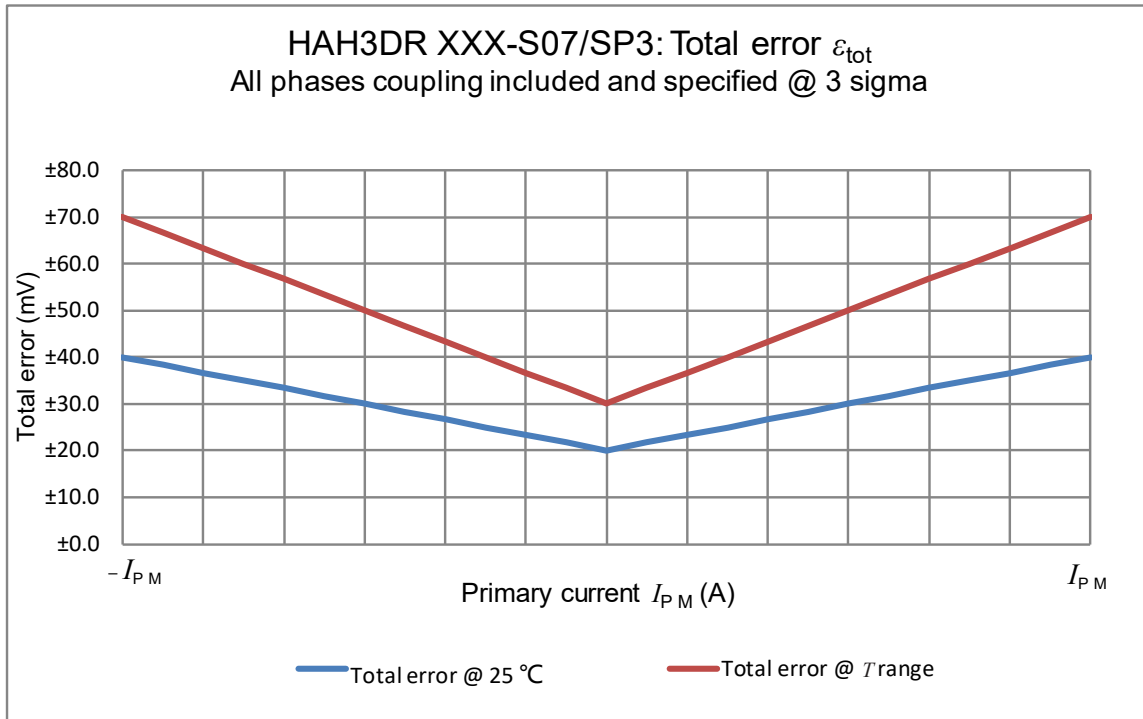

Total error table

I_p (A)	Total error ϵ_{tot} Specification			
	$T_A = 25\text{ °C}, U_C = 5\text{ V}$		$-40\text{ °C} \leq T_A \leq 125\text{ °C}, U_C = 5\text{ V}$	
I_{PM}	±40 mV	±2 %	±70 mV	±3.5 %
0	±20 mV	±1 %	±30 mV	±1.5 %
$-I_{PM}$	±40 mV	±2 %	±70 mV	±3.5 %

Return Busbar Influence On Transducer Output

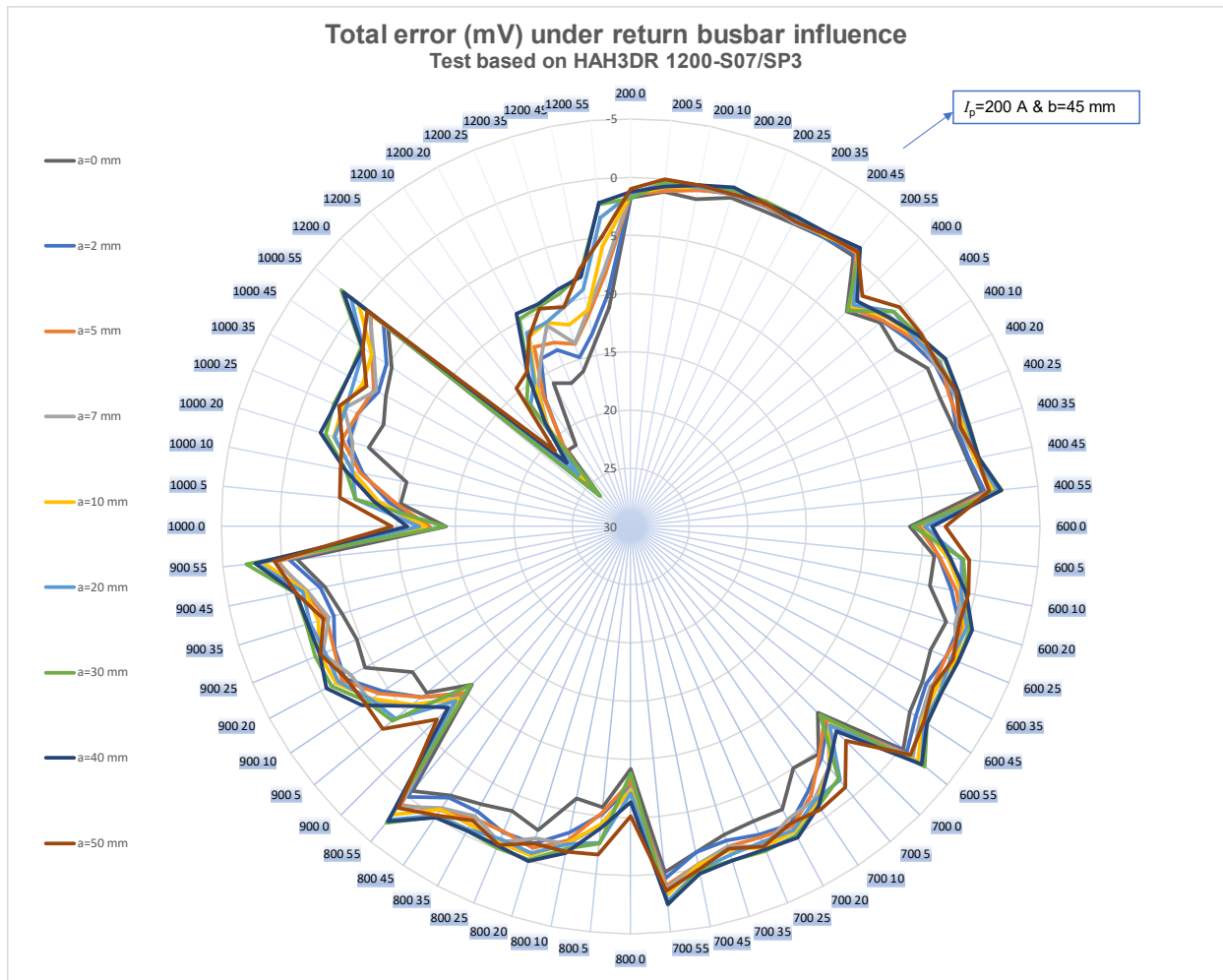
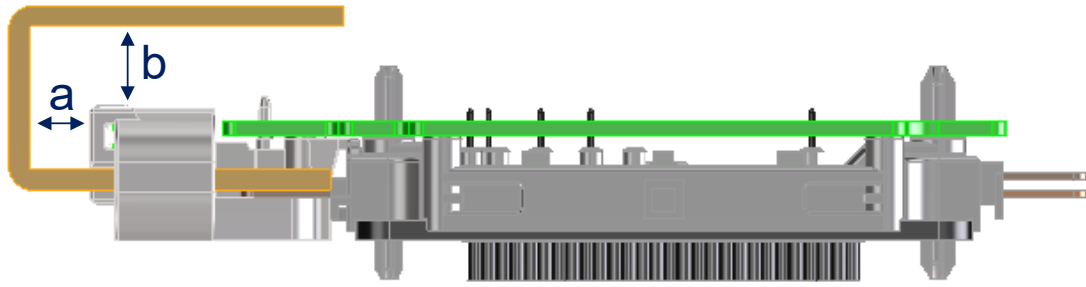

*Return Busbar Influence:

Difference of the U_{out} between the return busbar (U-shape) vs reference (straight busbar).

PERFORMANCES PARAMETERS DEFINITIONS

Primary current definition:

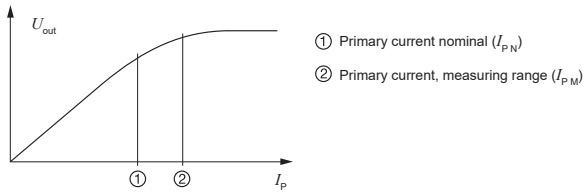

Definition of typical, minimum and maximum values:

Minimum and maximum values for specified limiting and safety conditions have to be understood as such as values shown in "typical" graphs. On the other hand, measured values are part of a statistical distribution that can be specified by an interval with upper and lower limits and a probability for measured values to lie within this interval. Unless otherwise stated (e.g. "100 % tested"), the LEM definition for such intervals designated with "min" and "max" is that the probability for values of samples to lie in this interval is 99.73 %. For a normal (Gaussian) distribution, this corresponds to an interval between -3 sigma and +3 sigma. If "typical" values are not obviously mean or average values, those values are defined to delimit intervals with a probability of 68.27 %, corresponding to an interval between -sigma and +sigma for a normal distribution. Typical, minimum and maximum values are determined during the initial characterization of a product.

Output noise voltage:

The output voltage noise is the result of the noise floor of the Hall elements and the linear amplifier.

Magnetic offset:

The magnetic offset is the consequence of an any current on the primary side. It's defined after a stated excursion of primary current.

Linearity:

The maximum positive or negative discrepancy with a reference straight line $U_{out} = f(I_p)$.
Unit: linearity (%) expressed with full scale of I_{pN} .

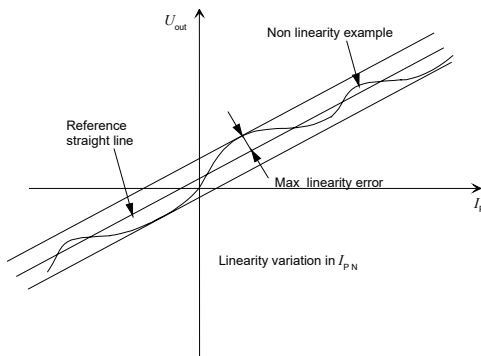

Delay time t_{D90} :

The time between the primary current signal (I_{pN}) and the output signal reach at 90 % of its final value.

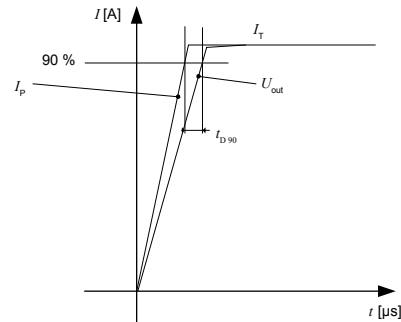

Sensitivity:

The transducer's sensitivity S is the slope of the straight line $U_{out} = f(I_p)$, it must establish the relation:

$$U_{out}(I_p) = U_c / 5 (S \times I_p + U_o)$$

Offset with temperature:

The error of the offset in the operating temperature is the variation of the offset in the temperature considered with the initial offset at 25 °C.

The offset variation I_{OT} is a maximum variation the offset in the temperature range:

$$I_{OT} = I_{OE \max} - I_{OE \min}$$

The offset drift $TCl_{OE \text{ AV}}$ is the I_{OT} value divided by the temperature range.

Sensitivity with temperature:

The error of the sensitivity in the operating temperature is the relative variation of sensitivity with the temperature considered with the initial offset at 25 °C.

The sensitivity variation S_T is the maximum variation (in ppm or %) of the sensitivity in the temperature range:
 $S_T = (\text{Sensitivity max} - \text{Sensitivity min}) / \text{Sensitivity at } 25 \text{ }^\circ\text{C}$.

The sensitivity drift TCS_{AV} is the S_T value divided by the temperature range. Deeper and detailed info available is our LEM technical sales offices (www.lem.com).

Offset voltage @ $I_p = 0$ A:

The offset voltage is the output voltage when the primary current is zero. The ideal value of U_o is $U_c / 2$. So, the difference of $U_o - U_c / 2$ is called the total offset voltage error. This offset error can be attributed to the electrical offset (due to the resolution of the ASIC quiescent voltage trimming), the magnetic offset, the thermal drift and the thermal hysteresis. Deeper and detailed info available is our LEM technical sales offices (www.lem.com).

Environmental test specifications:

Refer to LEM GROUP test plan laboratory CO.11.11.515.0 with "Tracking_Test Plan_Auto" sheet.

Environmental test specifications:

Name	Standard	Conditions
Electrical tests		
Phase delay check	LEM Procedure	30 Hz to 100 kHz @ 20 A peak
Frequency Bandwidth	LEM Procedure	30 Hz to 100 kHz @ 20 A peak
Noise measurement	LEM Procedure	Sweep from DC to 1 MHz
Delay time di/dt	LEM Procedure	100 A/ μ s, I pulse = 1200 A
dv/dt	LEM Procedure	5000 V/ μ s, U = 1000 V
Dielectric Withstand Voltage test	ISO 16750-2 § 4.11	2500 V AC/ 1 min/ 50 Hz
Insulation resistance	GBT 18488.1-2015	1000 V DC, time = 60 s $R_{INS} \geq 20$ M Ω minimum
Environmental tests		
Steady state T° C Humidity bias life test	JESD 22-A101 (03.2009)	1000 hours +85 $^{\circ}$ C/ 85 % RH $U_C = 5$ V , $I_p = 0$ A
Low temperature storage test	ISO 16750-4 § 5.1.1.1 (04.2010) IEC 60068-2-1 Ad (03.2007)	Storage: -40 $^{\circ}$ C for 96 h U_C not connected, $I_p = 0$ A
High temperature storage test	ISO16750-4 § 5.1.2.1 (04.2010) IEC 60068-2-2 Bd (07.2007)	Storage: 125 $^{\circ}$ C for 1000 h U_C not connected, $I_p = 0$ A
Thermal Shock	ISO16750-4 § 5.3.2 (04.2010) IEC 60068-2-14 Na (01.2009)	1000 cycles (1000 hours), 30 min @ -40 $^{\circ}$ C//30 mn @ +125 $^{\circ}$ C U_C not connected, $I_p = 0$ A
Power Temperature cycle test	ISO 16750-4 § 5.3.1 (04.2010) IEC 60068-2-14 Na (01.2009)	30 cycles(240 h), -40 $^{\circ}$ C \pm 125 $^{\circ}$ C $U_C = 5$ V , $I_p = 0$ A
Mechanical tests		
Mechanical Shock	ISO 16750-3 § 4.2.2 (12.2012)	50 g/ 6 ms Half Sine @ 25 $^{\circ}$ C 10 shocks of each direction (Total: 60) U_C not connected, $I_p = 0$ A
Sine Vibration in 25 $^{\circ}$ C	IEC 60068-2-6	Sine 30-60 m/s ² , 100 Hz - 440 Hz@ 25 $^{\circ}$ C 22 hr/axis $U_C = 5$ V , $I_p = 0$ A
Random Vibration in T° C	IEC 60068-2-64	96 m/s ² ,10 Hz - 2000 Hz, -40 $^{\circ}$ C < T < 125 $^{\circ}$ C 22 hr/axis $U_C = 5$ V , $I_p = 0$ A
Free Fall (Device not packed)	ISO 16750-3 § 4.3 (12.2012)	Height = 1 m, Concrete floor 3 axes, 2 directions by axis, 1 sample by axis
EMC test		
Radiated Emission	CISPR 25:2016	0.15 MHz to 2500 MHz Table 9,Class 5
Bulk Current Injection (BCI)	ISO 11452-4:2005	1 MHz to 400 MHz Level: 2 Criteria: A
Absorber-lined shielded enclosure	ISO 11452-2:2004	F = 400 MHz to 1 GHz; Level = 100 V/m (CW, AM 80 %) F = 0.8 GHz to 2 GHz; Level = 70 V/m (CW, PM PRR = 217 Hz , PD = 0.57 ms)
ESD Test	ISO 10605 (07.2008) IEC 61000-4-2	Contact: ± 4 , ± 6 kV Air: ± 8 kV U_C not connected

单击下面可查看定价，库存，交付和生命周期等信息

[>>LEM\(莱姆\)](#)